

**ADVANCED
NAVIGATION**



**Boreas A90
Boreas A70**

Reference Manual

Contents

1 Revision History	1
2 Introduction	2
2.1 Firmware Changelog	3
2.2 Hardware Changelog	3
3 Evaluation Kit	4
3.1 Evaluation Kit Contents	5
4 Getting Started	7
5 Part Numbers and Ordering	8
5.1 Evaluation Kit	8
5.2 Standalone Units	8
5.3 Software License Upgrades	8
5.4 Accessories	9
6 Specifications	10
6.1 Navigation Specifications	10
6.1.1 Sensor Specifications	11
6.1.1.1 Boreas A70	11
6.1.1.2 Boreas A90	11
6.2 Hardware Specifications	12
6.2.1 Environmental Specifications	12
6.2.2 Mechanical Drawings	13
6.2.3 Cable Bend Radius	14
6.3 Ground Strap	14
6.3.1 Ground Strap Point Drawing	15
6.3.2 Serial Number	16
6.4 Communication Specifications	17
6.5 Electrical Specifications	17
6.6 Ethernet Connection	19
6.7 IO Connection	20
6.7.1 IO Unterminated Cable	20
6.7.2 IO Breakout Cable	22
6.7.3 Custom IO Termination	24
7 Installing Boreas	25
7.1 Installation Checklist	25
7.2 Mounting Boreas	26

7.3 Mounting Alignment	29
7.4 Cable Bend Radius	30
7.5 MIL-DTL-38999 Series III Connector Mating	31
7.6 Power Supply	31
7.7 Electrical Domains	31
7.8 Networking	32
7.9 Odometer	32
7.9.1 Factory VSS Signal	32
7.9.2 OBDII Odometer Interface	33
7.9.3 Aftermarket Wheel Speed Sensor	33
7.9.4 Radar Speed Sensor	34
7.10 Magnetics	34
7.11 Vibration	34
8 Using Boreas	35
8.1 Filter Initialisation	35
8.1.1 Orientation Initialisation	36
8.1.2 Navigation Initialisation	36
8.1.3 Heading Initialisation	36
8.1.4 Time Initialisation	36
8.2 Hot Start	36
8.3 Time	37
8.4 Heading Sources	37
8.4.1 North Seeking Gyrocompass Heading	37
8.4.2 Velocity Heading	38
8.4.3 External Heading	38
8.4.4 External Magnetometers Packet	38
8.5 Data Anti-aliasing	38
8.6 Vehicle Profiles	38
8.7 Atmospheric Altitude	38
8.8 Odometer Pulse Length	38
8.8.1 Calibrating Odometer Automatic Pulse Length	39
8.9 Reversing Detection	39
8.10 Motion Analysis	39
8.11 Kinematica Post Processing	39
8.12 Vents	40
8.13 Vessel Motion	40
8.13.0.1 Surge	40
8.13.0.2 Sway	40
8.13.0.3 Heave	40
8.14 Environmental Exposure	40
8.14.1 Temperature	41
8.14.2 Water	41

8.14.3 Salt	41
8.14.4 Dirt and Dust	41
8.14.5 pH Level	41
8.14.6 Shocks	41
8.14.7 Atmospheres	41
8.15 Upgrading the Boreas Firmware	42
9 Configuring and Monitoring Boreas	43
9.1 Using the Web User Interface	43
9.1.1 Main View	44
9.1.1.1 Status Indicator	44
9.1.1.2 Current Time, Position and Heading	45
9.1.1.3 Altitude Indicator	45
9.1.1.4 Satellites Table	45
9.1.1.5 Map	45
9.1.1.6 Map Controls	45
9.1.2 View Menu	45
9.1.2.1 Map	45
9.1.2.2 Device Information	46
9.1.2.3 Status	47
9.1.2.4 Satellites	47
9.1.2.5 Raw Sensors	48
9.1.2.6 Orientation	49
9.1.2.7 Position	50
9.1.2.8 Velocity and Acceleration	51
9.1.2.9 Vessel Motion	52
9.1.2.10 Coarse Heading Alignment	52
9.1.3 Configuration Menu	53
9.1.3.1 Filter Options	54
9.1.3.2 Data Ports	55
9.1.3.3 Alignment	56
9.1.3.4 Baud Rates	57
9.1.3.5 GPIO	57
9.1.3.6 Odometer	57
9.1.3.7 Reset	58
9.1.3.8 Manual Initialisation	58
9.1.3.9 Ethernet Settings	59
9.1.3.10 NTRIP Client	59
9.1.3.11 CAN Settings	61
9.1.3.12 Advanced	61
9.1.4 Tools Menu	61
9.1.4.1 Firmware Update	62
9.1.4.2 Logs	63

9.1.4.3 Viewing Logged Data	64
9.2 Using Boreas Manager	65
9.2.1 Boreas Manager Software Changelog	66
9.2.2 System Requirements	67
9.2.3 Installation and Starting	67
9.2.4 Troubleshooting	67
9.2.4.1 Windows	67
9.2.4.2 Linux	69
9.2.5 Main View	70
9.2.5.1 Serial Port	70
9.2.5.2 Attitude Indicator	71
9.2.5.3 Satellites Table	71
9.2.5.4 Status Indicator	71
9.2.5.5 3D Map	71
9.2.5.6 3D Map Controls	71
9.2.5.7 Baud Rate	71
9.2.5.8 Connect / Disconnect	71
9.2.6 View Menu	72
9.2.6.1 View	72
9.2.6.2 Device Information	72
9.2.6.3 Status	73
9.2.6.4 Satellites	73
9.2.6.5 Raw Sensors	74
9.2.6.6 Orientation	75
9.2.6.7 Position	76
9.2.6.8 Velocity and Acceleration	77
9.2.6.9 Time	77
9.2.6.10 Communications	78
9.2.6.11 Vessel Motion	79
9.2.6.12 North Seeking Status	79
9.2.7 Configuration Menu	81
9.2.7.1 Configuration Export	81
9.2.7.2 Filter Options	82
9.2.7.3 Packet Rates	83
9.2.7.4 Alignment	84
9.2.7.5 Baud Rates	85
9.2.7.6 GPIO	85
9.2.7.7 Odometer	86
9.2.7.8 Reset	86
9.2.7.9 Reference Position Offsets	87
9.2.7.10 GPIO Output	88
9.2.7.11 Manual Initialisation	89
9.2.7.12 Gimbal	89

9.2.7.13 Ethernet Settings	90
9.2.7.14 CAN Settings	90
9.2.8 Tools Menu	91
9.2.8.1 Firmware Update	91
9.2.8.2 Log Converter	94
9.2.9 Logging	94
9.3 Using the Android App	95
9.4 Using ANPP	95
10 Interfacing	96
10.1 Ethernet	96
10.1.1 Ethernet Modes	96
10.1.2 Ethernet Functions	97
10.1.2.1 NMEA Input	98
10.1.2.2 Novatel GNSS Input	98
10.1.2.3 Topcon GNSS Input	98
10.1.2.4 ANPP Input	98
10.1.2.5 RTCM Differential GNSS Corrections Input	99
10.1.2.6 Trimble GNSS Input	99
10.1.2.7 u-blox GNSS Input	99
10.1.2.8 Hemisphere GNSS Input	99
10.1.2.9 Teledyne DVL Input	99
10.1.2.10 Trittech USBL Input	99
10.1.2.11 Linkquest DVL Input	99
10.1.2.12 Nortek DVL Input	99
10.1.2.13 NMEA Output	99
10.1.2.14 ANPP Output	100
10.1.2.15 TSS1 Output	100
10.1.2.16 Simrad 1000 Output	100
10.1.2.17 Simrad 3000 Output	100
10.1.2.18 Serial Port Passthrough	100
10.1.2.19 GNSS Receiver Passthrough	100
10.2 Serial Interface	101
10.2.1 Baud Rate	101
10.2.2 Format	101
10.3 1PPS Signal	101
10.4 CAN Interface	101
10.5 External Data	102
10.6 GPIO Pins and the Auxiliary Port	102
10.6.1 Dynamic Pin Functions	103
10.6.1.1 Inactive	104
10.6.1.2 1PPS Output	104
10.6.1.3 GNSS Fix Output	105

10.6.1.4 Zero Velocity Input	105
10.6.1.5 Disable GNSS	105
10.6.1.6 Disable Pressure	105
10.6.1.7 Set Zero Orientation Alignment	106
10.6.1.8 System State Packet Trigger	106
10.6.1.9 Raw Sensors Packet Trigger	106
10.6.1.10 1PPS Input	106
10.6.1.11 Event 1 Input	107
10.6.1.12 Event 2 Input	107
10.6.1.13 Odometer Direction, Forward Low	107
10.6.1.14 Odometer Direction, Forward High	107
10.6.1.15 Reverse Alignment, Forward Low	107
10.6.1.16 Reverse Alignment, Forward High	108
10.6.1.17 Zero Angular Velocity Input	108
10.6.1.18 Odometer Input	108
10.6.1.19 Pitot Tube Input	108
10.6.1.20 Pressure Depth Transducer (deprecated)	109
10.6.1.21 Left Wheel Speed Sensor	109
10.6.1.22 Right Wheel Speed Sensor	109
10.6.1.23 Wheel Speed Sensor	109
10.6.1.24 Wheel Encoder Phase A	109
10.6.1.25 Wheel Encoder Phase B	110
10.6.1.26 Gimbal Encoder Phase A	110
10.6.1.27 Gimbal Encoder Phase B	110
10.6.1.28 NMEA Input	110
10.6.1.29 Novatel GNSS Input	111
10.6.1.30 Topcon GNSS Input	111
10.6.1.31 ANPP Input	111
10.6.1.32 RTCM Differential GNSS Corrections Input	112
10.6.1.33 Trimble GNSS Input	112
10.6.1.34 u-blox GNSS Input	112
10.6.1.35 Hemisphere GNSS Input	112
10.6.1.36 Teledyne DVL Input	113
10.6.1.37 Trittech USBL Input	113
10.6.1.38 Linkquest DVL Input	113
10.6.1.39 Linkquest USBL Input	113
10.6.1.40 Nortek DVL Input	113
10.6.1.41 NMEA Output	114
10.6.1.42 ANPP Output	114
10.6.1.43 TSS1 Output	114
10.6.1.44 Simrad 1000 Output	115
10.6.1.45 Simrad 3000 Output	115
10.6.1.46 Serial Port Passthrough	115

10.6.1.47 GNSS Receiver Passthrough	115
11 Advanced Navigation Packet Protocol	116
11.1 About Packets	118
11.1.1 Packet Structure	118
11.1.1.1 Header LRC	118
11.1.1.2 Packet ID	119
11.1.1.3 Packet Length	119
11.1.1.4 CRC	119
11.1.2 Packet Requests	119
11.1.3 Packet Acknowledgement	119
11.1.4 Packet Rates	119
11.1.5 Packet Timing	119
11.2 Data Types	120
11.3 System Packets	120
11.3.1 Acknowledge Packet	120
11.3.1.1 Acknowledge Result	121
11.3.2 Request Packet	121
11.3.3 Boot Mode Packet	121
11.3.3.1 Boot Mode Types	121
11.3.4 Device Information Packet	122
11.3.4.1 Device ID	122
11.3.5 Restore Factory Settings Packet	123
11.3.6 Reset Packet	123
11.3.6.1 Verification Sequence Values	123
11.3.7 Serial Port Passthrough Packet	123
11.3.7.1 Passthrough Route	124
11.3.8 IP Configuration Packet	125
11.3.8.1 DHCP Mode	125
11.3.8.2 Link Mode Index	125
11.3.8.3 Discovery Network Setting Overwrite	125
11.4 State Packets	126
11.4.1 System State Packet	128
11.4.1.1 System Status	129
11.4.1.2 Filter Status	130
11.4.1.3 GNSS Fix Status	130
11.4.1.4 Unix Time Seconds	130
11.4.1.5 Microseconds	131
11.4.2 Unix Time Packet	131
11.4.3 Formatted Time Packet	131
11.4.4 Status Packet	132
11.4.5 Position Standard Deviation Packet	132
11.4.6 Velocity Standard Deviation Packet	132

11.4.7 Euler Orientation Standard Deviation Packet	133
11.4.8 Quaternion Orientation Standard Deviation Packet	133
11.4.9 Raw Sensors Packet	134
11.4.10 Raw GNSS Packet	135
11.4.10.1 Raw GNSS Status	135
11.4.11 Satellites Packet	136
11.4.12 Geodetic Position Packet	137
11.4.13 ECEF Position Packet	137
11.4.14 UTM Position Packet	137
11.4.15 NED Velocity Packet	138
11.4.16 Body Velocity Packet	138
11.4.17 Acceleration Packet	138
11.4.18 Body Acceleration Packet	139
11.4.19 Euler Orientation Packet	139
11.4.20 Quaternion Orientation Packet	139
11.4.21 DCM Orientation Packet	140
11.4.22 Angular Velocity Packet	140
11.4.23 Angular Acceleration Packet	141
11.4.24 External Position and Velocity Packet	141
11.4.25 External Position Packet	142
11.4.26 External Velocity Packet	142
11.4.27 External Body Velocity Packet	143
11.4.28 External Heading Packet	143
11.4.29 Running Time Packet	143
11.4.30 Odometer State Packet	144
11.4.31 External Time Packet	144
11.4.32 External Depth Packet	144
11.4.33 Geoid Height Packet	145
11.4.34 Wind Packet	145
11.4.35 Heave Packet	145
11.4.36 External Odometer Packet	146
11.4.36.1 Odometer Flags	146
11.4.37 External Air Data Packet	147
11.4.37.1 External Air Data Flags	147
11.4.38 Raw DVL Data Packet	148
11.4.38.1 Raw DVL Data Flags	148
11.4.39 North Seeking Initialisation Status Packet	148
11.4.39.1 North Seeking Initialisation Status Flags	149
11.4.40 Gimbal State Packet	149
11.4.41 Automotive Packet	150
11.4.42 Basestation Packet	150
11.4.42.1 GNSS Fix Status	151
11.4.43 Zero Angular Velocity Packet	151

11.4.43.1 Zero Angular Velocity Duration	151
11.4.44 Vessel Motion Packet	151
11.4.45 System Temperature Packet	152
11.5 Configuration Packets	152
11.5.1 Packet Timer Period Packet	153
11.5.1.1 UTC Synchronisation	153
11.5.1.2 Packet Timer Period	153
11.5.2 Packets Period Packet	153
11.5.2.1 Clear Existing Packets	154
11.5.2.2 Packet Period	154
11.5.3 Baud Rates Packet	154
11.5.3.1 Supported Baud Rate	155
11.5.4 Installation Alignment Packet	155
11.5.4.1 Alignment DCM	157
11.5.5 Filter Options Packet	157
11.5.5.1 Vehicle Types	157
11.5.6 GPIO Configuration Packet	158
11.5.6.1 GPIO Functions	159
11.5.6.2 Auxiliary Functions	160
11.5.6.3 GPIO Voltage Selection	162
11.5.7 Odometer Configuration Packet	162
11.5.8 Set Zero Orientation Alignment Packet	162
11.5.9 Reference Point Offsets Packet	163
11.5.10 GPIO Output Configuration Packet	164
11.5.10.1 Port Input Modes	165
11.5.10.2 Port Output Modes	165
11.5.10.3 NMEA Fix Behaviour	165
11.5.10.4 Port Output Rates	166
11.5.11 User Data Packet	166
11.5.12 GPIO Input Configuration Packet	166
11.5.13 CAN Configuration Packet	167
11.5.13.1 CAN Protocol	167
12 Reference Information	168
12.1 Technology Overview	168
12.1.1 GNSS	168
12.1.2 AHRS	168
12.1.3 INS	168
12.1.4 GNSS/INS	168
12.2 The Sensor Co-ordinate Frame	169
12.2.1 Right Hand Rule	169
12.3 The Body Co-ordinate Frame	170
12.4 Roll, Pitch and Heading	170

12.4.1 Second Right Hand Rule	170
12.4.2 Rotation Order	171
12.5 Geodetic Co-ordinate System	171
12.5.1 Latitude and Longitude	172
12.5.2 Height	174
12.6 NED Co-ordinate Frame	175
12.7 ECEF Co-ordinate Frame	175

DISCLAIMER

Information in this document is provided solely in connection with Advanced Navigation products. Advanced Navigation reserves the right to make changes, corrections, modifications or improvements, to this document, and the products and services described herein at any time, without notice.

All Advanced Navigation products are sold pursuant to Advanced Navigation's terms and conditions of sale.

Purchasers are solely responsible for the choice, selection and use of the Advanced Navigation products and services described herein, and to the extent permitted by law, Advanced Navigation assumes no liability whatsoever relating to, or in anyway connected to, the choice, selection or use of the Advanced Navigation products and services described herein.

No license, express or implied, by estoppel or otherwise, to any intellectual property rights is granted under this document. If any part of this document refers to any third party products or services it shall not be deemed a license grant by Advanced Navigation for the use of such third party products or services, or any intellectual property contained therein or considered as a warranty covering the use in any manner whatsoever of such third party products or services or any intellectual property contained therein.

UNLESS OTHERWISE SET FORTH IN ADVANCED NAVIGATION'S TERMS AND CONDITIONS OF SALE ADVANCED NAVIGATION DISCLAIMS ANY EXPRESS OR IMPLIED WARRANTY WITH RESPECT TO THE USE AND/OR SALE OF ADVANCED NAVIGATION PRODUCTS INCLUDING WITHOUT LIMITATION IMPLIED WARRANTIES OF MERCHANTABILITY, FITNESS FOR A PARTICULAR PURPOSE (AND THEIR EQUIVALENTS UNDER THE LAWS OF ANY JURISDICTION), FAULT TOLERANCE OR INFRINGEMENT OF ANY PATENT, COPYRIGHT OR OTHER INTELLECTUAL PROPERTY RIGHT.

UNLESS EXPRESSLY APPROVED IN WRITING BY TWO AUTHORIZED ADVANCED NAVIGATION REPRESENTATIVES, ADVANCED NAVIGATION PRODUCTS ARE NOT RECOMMENDED, AUTHORIZED OR WARRANTED FOR USE IN MILITARY, AIR CRAFT, SPACE, LIFE SAVING, OR LIFE SUSTAINING APPLICATIONS OR HAZARDOUS OR HIGH RISK ENVIRONMENTS REQUIRING FAIL-SAFE OR FAULT TOLERANT PERFORMANCE, NOR IN PRODUCTS OR SYSTEMS WHERE FAILURE OR MALFUNCTION MAY RESULT IN PERSONAL INJURY, DEATH, OR SEVERE PROPERTY OR ENVIRONMENTAL DAMAGE. SUCH USE IS AT PURCHASERS OWN RISK, EVEN IF ADVANCED NAVIGATION KNOWS OF SUCH USE.

ADVANCED NAVIGATION PRODUCTS WHICH ARE NOT SPECIFIED AS "AUTOMOTIVE GRADE" MAY ONLY BE USED IN AUTOMOTIVE APPLICATIONS AT USER'S OWN RISK.

Resale of Advanced Navigation products with provisions different from the statements and/or technical features set forth in this document shall immediately void any warranty granted by Advanced Navigation for the Advanced Navigation product or service described herein and shall not create or extend in any manner whatsoever, any liability of Advanced Navigation.

Information in this document supersedes and replaces all information previously supplied. References to Advanced Navigation in this disclaimer includes its related bodies corporate.

Document Version: 1.2 Publication Date: 19 Apr 2024

For more information, contact technical support via email at support@advancednavigation.com.

© 2024 Advanced Navigation - All rights reserved

1 Revision History

Version	Date	Changes
1.2	19 April 2024	Updated firmware changelog, see 2.1 Firmware Changelog Updated software changelog, see 9.2.1 Boreas Manager Software Changelog Added Vessel Motion packet, see 11.4.44 Vessel Motion Packet Added Train vehicle type to Filter Options packet, see 11.5.5 Filter Options Packet Updated WebUI and Boreas Manager screenshots
1.1	23 Nov 2023	Updated weight and improved detail of Hardware Specifications Added 6.3 Ground Strap details Expanded 9.2 Using Boreas Manager to include all features Updated software changelog, see 9.2.1 Boreas Manager Software Changelog
1.0	11 July 2023	First release

Table 1: Revision History

2 Introduction

Boreas A90/A70 is an ultra high accuracy DFOG AHRS that provides accurate acceleration and orientation under the most demanding conditions. It combines cutting edge Fibre Optic Gyroscopes (FOG) technology with closed loop accelerometers, which are coupled in a sophisticated fusion algorithm to deliver accurate and reliable orientation. The system features ultra fast gyrocompassing heading that works under all conditions.

Note: Boreas AHRS variants can be upgraded to full INS capability through a software license upgrade. Position and navigation functionality is only to be used when licensed as an INS. As an INS it can be interfaced to any leading brand of GNSS receivers to create an OEM GNSS/INS solution.

Boreas is available in two different performance classes, the Boreas A90 and the Boreas A70. See [6 Specifications](#) for a performance comparison between the two products. See [5 Part Numbers and Ordering](#) for more information.



Figure 1: Boreas

Boreas is a compact, light-weight AHRS system that:

- Provides unparalleled accuracy, stability and reliability with its use of the revolutionary Digital FOG (DFOG) technology
- Can be upgraded to full INS capability through a software license upgrade.
- Rapidly acquires accurate heading information using Digital FOG (DFOG) gyroscopes in conjunction with an innovative north-seeking algorithm
- Extracts greater usable information from sensor data using Advanced Navigation's AI-based sensor filter
- Is designed and built to be tough, tested to high safety standards and resistant to shock and vibration, allowing it to be used in extreme conditions
- Features multiple interfaces including Ethernet, CAN, RS232, RS422 and general-purpose IO

- Supports all industry-standard protocols including NMEA 0183 and NMEA 2000 and a wide variety of proprietary protocols.

Note: For information about Global Navigation Satellite Systems (GNSS), Inertial Navigation Systems (INS) and related concepts explained in simple terms, see [12 Reference Information](#).

Use the links below for detailed information about Boreas.

- [5 Part Numbers and Ordering](#)
- [6 Specifications](#)
- [7 Installing Boreas](#)
- [8 Using Boreas](#)
- [9 Configuring and Monitoring Boreas](#)
- [10 Interfacing](#)
- [11 Advanced Navigation Packet Protocol](#)

2.1 Firmware Changelog

Version	Date	Changes
1.81	03 April 2024	Initial release

Table 2: Firmware Changelog

Note: To upgrade the firmware to the latest version, see [8.15 Upgrading the Boreas Firmware](#).

2.2 Hardware Changelog

Version	Date	Changes
1.1	July 2023	Initial release

Table 3: Hardware Changelog

3 Evaluation Kit

The Evaluation Kit provides the necessary parts and accessories to set up and connect a Boreas unit. It is supplied in a rugged transport case to protect the equipment during transit.



Figure 2: Boreas Evaluation Kit Transport Case

3.1 Evaluation Kit Contents



Figure 3: Boreas Evaluation Kit Contents

Part Number	Quantity	Description	Notes
BOREAS-A90 or BOREAS-A70	1	Boreas AHRS Unit	Boreas unit in rugged enclosure
CABLE-FTDI	1	RS232/422 Adaptor to USB	FTDI USB to RS232 / RS422 (selectable) 1 metre cable
CABLE-38999-RJ45-3M	1	Ethernet MIL-DTL-38999 Series III RJ45 to RJ45 3 m	Ethernet cable 3 m industrial MIL-DTL-38999 Series III RJF TV RJ45 male to RJ45 male See 6.6 Ethernet Connection .
CABLE-38999-19-32-BREAKOUT	1	Breakout cable for IO connection	Breakout cable for IO connection 2 m MIL-DTL-38999 Series III Size 19, 32-pin connector Connectors for Primary, Auxiliary, CAN, GPIO, 1PPS, Alert and Power. See 6.7.2 IO Breakout Cable .
SUPPLY-24V	1	24 V DC power supply	100-240 V AC Mains to 24 V DC Power Supply (DC jack) Includes 2-pin plug types A/C/G/I
38999-19-CAP	1	Waterproof cap for Size 19 MIL-DTL-38999 Series III socket connector	Used to maintain IP67 rating when not using an Ethernet connection
BOREAS90-KIT-CASE	1	Boreas Evaluation Kit case	Rugged transport case

Table 4: Evaluation Kit Contents

4 Getting Started

To get started with Boreas for the first time, it is recommended that you begin by establishing communications to the device, either before or after the unit is installed in its final location. These instructions assume the use of components provided in the [3 Evaluation Kit](#), or purchased as Advanced Navigation supplied optional [5.4 Accessories](#).

1. Plug the power supply into the power connector on the breakout cable and then into the wall socket. See [7.6 Power Supply](#).
2. Plug the IO breakout cable into the IO connector on the Boreas unit. See [6.7 IO Connection](#).
3. Connect either the MIL-DTL-38999 Series III terminated cable or a standard Ethernet cable from the Ethernet socket on the Boreas unit to your network or switch. See [6.6 Ethernet Connection](#).
4. If using Windows, download and install the Bonjour ZeroConf networking utility from the link <https://www.advancednavigation.com/Bonjour64.msi>.
5. In a web browser, type the address: <http://boreas.local>.

There are additional factors that you must review **before** you proceed with the installation. For more information, see [7 Installing Boreas](#).

5 Part Numbers and Ordering

This topic covers information about:

- [5.1 Evaluation Kit](#)
- [5.2 Standalone Units](#)
- [5 Part Numbers and Ordering](#)
- [5.4 Accessories](#)

5.1 Evaluation Kit

Part Number	Description
BOREAS-A90-EK	Boreas A90 AHRS Evaluation Kit Includes the items listed in 3.1 Evaluation Kit Contents
BOREAS-A70-EK	Boreas A70 AHRS Evaluation Kit Includes the items listed in 3.1 Evaluation Kit Contents

Table 5: Evaluation Kit Part Numbers

5.2 Standalone Units

Part Number	Description	Notes
BOREAS-A90	Boreas A90 Unit	Boreas A90 unit in rugged enclosure No cables or blanking caps included
BOREAS-A70	Boreas A70 Unit	Boreas A70 unit in rugged enclosure No cables or blanking caps included

Table 6: Standalone Unit Part Numbers

5.3 Software License Upgrades

Note: Boreas AHRS variants can be upgraded to full INS capability through a software license upgrade. Position and navigation functionality is only to be used when licensed as an INS. As an INS it can be interfaced to any leading brand of GNSS receivers to create an OEM GNSS/INS solution.

These license upgrades can either be ordered with the unit or purchased later.

Part Number	Description	Notes
BOREAS-A90-LIC-INS	License to upgrade Boreas A90 to INS functionality	Upgrade Boreas A90 to INS functionality. Required to use: Navigation, Position, External GNSS receiver
BOREAS-A70-LIC-INS	License to upgrade Boreas A70 to INS functionality	Upgrade Boreas A70 to INS functionality. Required to use: Navigation, Position, External GNSS receiver

Table 7: Ordering Part Numbers for Software License Upgrades

5.4 Accessories

Part Number	Description	Notes
CABLE-38999-RJ45-3M	Ethernet MIL-DTL-38999 Series III RJ45 to RJ45 3 m	3 m industrial Ethernet cable MIL-DTL-38999 Series III RJF TV See 6.6 Ethernet Connection
CABLE-38999-RJ45-10M	Ethernet MIL-DTL-38999 Series III RJ45 to RJ45 10 m	10 m industrial Ethernet cable MIL-DTL-38999 Series III RJF TV See 6.6 Ethernet Connection
CABLE-38999-19-32-BREAKOUT	Breakout cable for IO connection	2 m breakout cable for IO connection MIL-DTL-38999 Series III Size 19, 32-pin connector Connectors for Primary, Auxiliary, CAN, GPIO, 1PPS, Alert and Power See 6.7 IO Connection .
CABLE-38999-19-32-UNT-5M	IO MIL-DTL-38999 Series III 5 m unterminated cable	MIL-DTL-38999 Series III 32-pin connector 5 m 26 core cable unterminated. See 6.7 IO Connection .
38999-19-CAP	Waterproof cap for Size 19 MIL-DTL-38999 Series III socket connector	Used to maintain IP67 rating when not using an Ethernet connection
CABLE-FTDI	USB to RS232 / RS422 cable 1 m	1 m FTDI USB to RS232 / RS422 (selectable) cable
SUPPLY-24V	24 V DC Power Supply	100-240 V AC Mains to 24 V DC Power Supply (DC jack) Includes 2-pin plug types A/C/G/I
CAR12VPWR	Car auxiliary power outlet supply	Car auxiliary power supply to DC jack power supply
OBDII-ODOMETER	OBDII Odometer	Allows vehicle-mounted units access to accurate odometer data. See 7.9.2 OBDII Odometer Interface
Various Air Data Units	Air Data Unit	Air data units provide pitot and static air velocity data aiding for Boreas in fixed wing aircraft
BOREAS90-KIT-CASE	Boreas Kit Case	Rugged transport case suitable for storing a single Boreas unit, 2 antennas, standard cables and power supply accessories.

Table 8: Ordering Part Numbers for Accessories

6 Specifications

Review the following specifications for Boreas:

- [6.1 Navigation Specifications](#)
- [6.2 Hardware Specifications](#)
- [6.4 Communication Specifications](#)
- [6.5 Electrical Specifications](#)
- [6.6 Ethernet Connection](#)
- [6.7 IO Connection](#)

6.1 Navigation Specifications

Specification	Boreas A70	Boreas A90
Roll & Pitch Accuracy	0.01 °	0.005 °
Roll & Pitch Accuracy (Kinematica post processing)	0.01 °	0.005 °
Heading Accuracy without GNSS (Secant Latitude RMS)	0.1 °	0.01 °
Gyrocompassing Coarse Alignment	2 min	2 min
Gyrocompassing Fine Alignment (typical)	10 min	10 min
Heave Accuracy (whichever is greater)	2 % or 0.02 m	2 % or 0.02 m
Rotation Range	Unlimited	Unlimited
Hot Start Time	2 s	2 s
Internal Filter Rate	1000 Hz	1000 Hz
Output Data Rate	1000 Hz	1000 Hz

Table 9: Boreas Orientation Specifications

Boreas can be upgraded to full INS capability through a software license upgrade. As an INS it can be interfaced to any of the leading brands of GNSS receivers to create an OEM GNSS/INS solution. When using a Trimble BD992 receiver, for example, the following specifications are achievable:

Specification	Boreas A70	Boreas A90
Horizontal Position Accuracy	1.2 m	1.2 m
Vertical Position Accuracy	2.0 m	2.0 m
Horizontal Position Accuracy (SBAS)	0.5 m	0.5 m
Vertical Position Accuracy (SBAS)	0.8 m	0.8 m
Horizontal Position Accuracy (with RTK or Kinematica Post Processing)	0.01 m	0.01 m
Vertical Position Accuracy (with RTK or Kinematica Post Processing)	0.015 m	0.015 m
Accuracy with Odometer without GNSS (% of distance travelled)	0.05%	0.01%
Accuracy with DVL without GNSS (% of distance travelled)	0.05%	0.01%

Specification	Boreas A70	Boreas A90
Velocity Accuracy	0.005 m/s	0.005 m/s
Heading Accuracy with Dual GNSS (1.0 m antenna separation)	0.01 °	0.006 °
Heading Accuracy (Kinematica post processing)	0.01 °	0.006 °

Table 10: Boreas Navigation Specifications (with external GNSS)

6.1.1 Sensor Specifications

6.1.1.1 Boreas A70

Parameter	Accelerometers	Gyroscopes	Pressure
Range	± 15 g	± 490 °/s	10 to 130 kPa
Bias Instability	7 ug	0.01 °/hr	8 Pa
Initial Bias	< 100 ug	< 0.05 °/hr	< 50 Pa
Initial Scaling Error	340 ppm	100 ppm	-
Scale Factor Stability	150 ppm	20 ppm	-
Non-linearity	150 ppm	10 ppm	-
Cross-axis Alignment Error	< 0.001 °	< 0.001 °	-
Noise Density	40 ug/√Hz	0.3 °/h/√Hz	0.4 Pa/√Hz
Random Walk	23 mm/s/√hr VRW	0.005 °/√h ARW	-
Bandwidth	300 Hz	400 Hz	50 Hz

Table 11: Boreas A70 Sensor Specifications

6.1.1.2 Boreas A90

Parameter	Accelerometers	Gyroscopes	Pressure
Range	± 15 g	± 490 °/s	10 to 130 kPa
Bias Instability	7 ug	0.001 °/hr	8 Pa
Initial Bias	< 100 ug	< 0.01 °/hr	< 50 Pa
Initial Scaling Error	340 ppm	80 ppm	-
Scale Factor Stability	100 ppm	10 ppm	-
Non-linearity	150 ppm	10 ppm	-
Cross-axis Alignment Error	< 0.001 °	< 0.001 °	-
Noise Density	30 ug/√Hz	0.06 °/h/√Hz	0.4 Pa/√Hz
Random Walk	17 mm/s/√hr VRW	0.001 °/√h ARW	-
Bandwidth	300 Hz	400 Hz	50 Hz

Table 12: Boreas A90 Sensor Specifications

Note: Boreas sensors are calibrated for bias, sensitivity, misalignment, cross-axis sensitivity, non-linearity and gyroscope linear acceleration sensitivity across the full operating temperature range.

6.2 Hardware Specifications

Specification	Value
Hot Start Battery Capacity	> 48 hours
Hot Start Battery Charge Time	30 minutes
Hot Start Battery Endurance	> 10 years
Mean Time between Failure (MTBF)	> 70,000 hours
Dimensions (depth x width x height) excluding connectors	160 mm x 140 mm x 115.5 mm
Weight	2.7 kg

Table 13: Hardware Specifications for Boreas

6.2.1 Environmental Specifications

Parameter	Specification	Standard
Operating and Storage Temperature	-40 °C to 75 °C	MIL-STD-810H Method 501.7 & 502.7
Humidity	Natural Cycle B1	MIL-STD-810H Method 507.6
Salt Fog	48 hours	MIL-STD-810H Method 509.7
Ingress Protection	IP67	IEC 60529 MIL-STD-810H Method 512.6
Vibration	7.7 g rms	MIL-STD-810H Method 514.8E-1 & 514.8C-3
Shock	50 g 11 ms	MIL-STD-810H Method 516.8

Table 14: Environmental specifications for Boreas

6.2.2 Mechanical Drawings

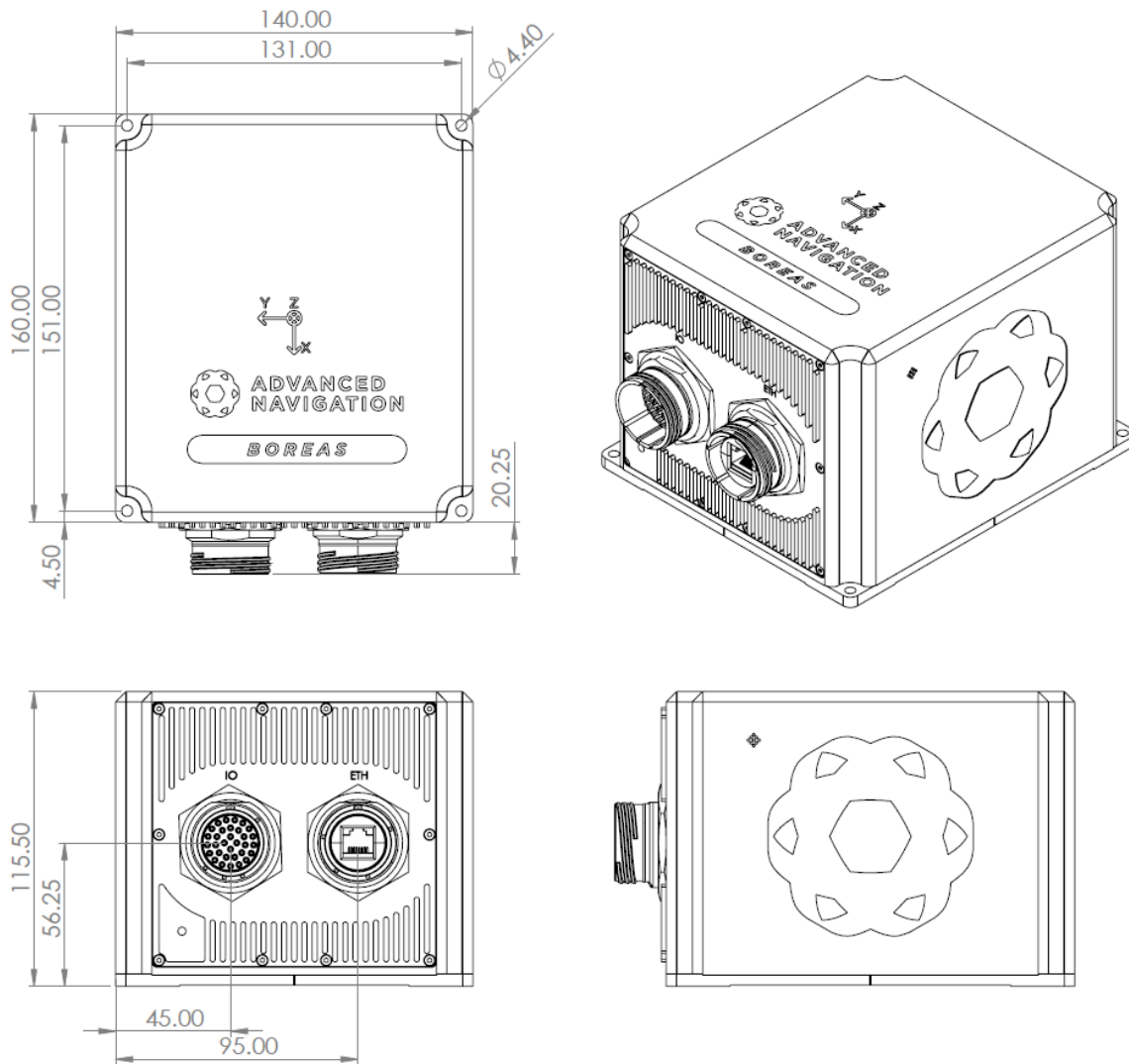

Figure 4: Mechanical Drawings of Boreas A90 and A70

6.2.3 Cable Bend Radius

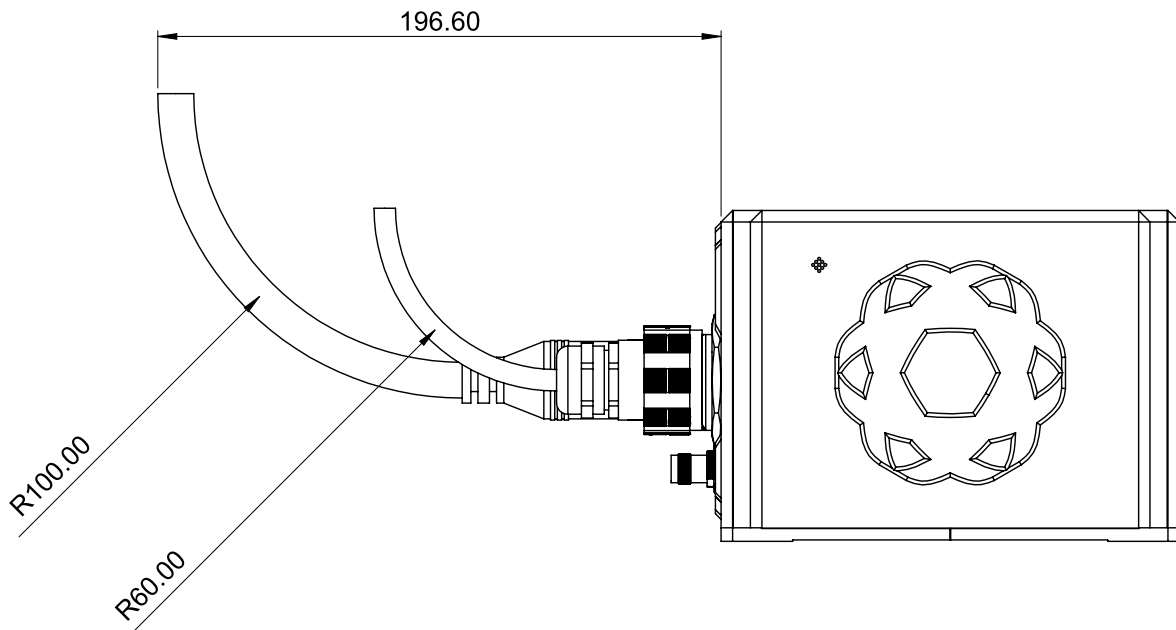

Figure 5: Recommended Minimum Bend Radius for Advanced Navigation Supplied Cables

6.3 Ground Strap

Boreas A90 and A70 features a single M4 x 6 mm threaded insert on the front face of the enclosure to be used to earth the unit.

Boreas should be connected to ground for safety, and to provide an outlet for excess current in the case of a fault in the system.

To safely earth Boreas, connect one side of a ground strap to the ground strap point on the enclosure, and the other end to the ground of the power supply, or directly to earth if the application is on a stationary object. Ensure that the ground strap used is of a gauge that will allow the current to be safely carried.

See [6.3.1 Ground Strap Point Drawing](#) for the location of the connection point on the enclosure of Boreas.

6.3.1 Ground Strap Point Drawing

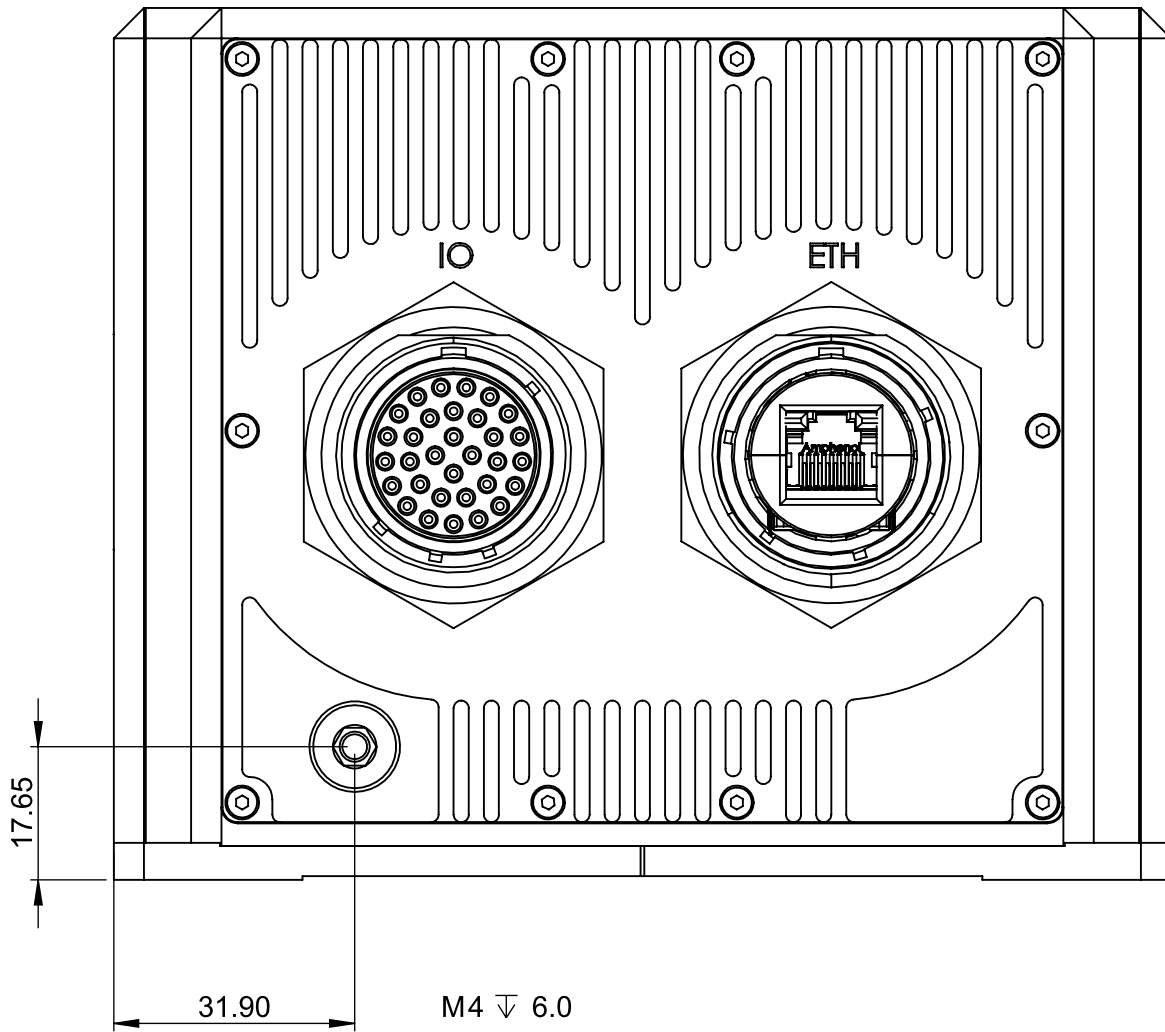

Figure 6: Location and Specifications of the Ground Thread

6.3.2 Serial Number

The device serial number can be inspected by using the Device Information page in the web interface (see [9.1 Using the Web User Interface](#)) or with the Manager application (see [9.2 Using Boreas Manager](#)). The serial number label is located on the outside rear of the enclosure with the serial number encoded in a 2D data matrix bar code to assist customers in tracking their units. The label also contains the hardware version and build date. Applications are available for most smartphones that can scan the 2D data matrix bar code to display the serial number.



Figure 7: Boreas External Serial Number Sticker

6.4 Communication Specifications

Specification	Value
Interfaces	Ethernet RS232/RS422 CAN 1PPS
Speed	100 Mbit Ethernet 4800 to 4 M baud serial
Protocols	Advanced Navigation Packet Protocol, NMEA or CANopen
Peripheral Interface	2 x GPIO 1 x 1PPS Output 1 x Auxiliary RS232 1 x Alarm Output
GPIO Operating Voltage Levels	5 V 3.3 V RS232
GPIO Functions	1PPS input/output Odometer input DVL/USBL input Air Data input Zero velocity input NMEA input/output Novatel GNSS input Trimble GNSS input Advanced Navigation Packet Protocol CAN/CANopen

Table 15: Communication Specifications

6.5 Electrical Specifications

Parameter	Minimum	Typical	Maximum
Operating Voltage	9 V		36 V
Input Protection	-200 V		+200 V
Power Consumption		10 W	15 W
Inrush Current		1.67 A at 12 V 0.79 A at 24 V	
RS232			
Tx Voltage Low		-5.4 V	-5 V
Tx Voltage High	5 V	5.4 V	
Tx Short Circuit Current			±60 mA

Parameter	Minimum	Typical	Maximum
Rx Threshold Low	0.6 V	1.2 V	
Rx Threshold High		1.5 V	2.0 V
RS422			
Tx Differential Output	1.5 V		
Tx Short Circuit Current			±250 mA
Rx Differential Threshold	-0.2 V		-0.05 V
GPIO when set to 5 V			
Output Voltage Low	0 V		0.3 V
Output Voltage High	4.8 V		5 V
Input Voltage	-20 V		20 V
Input Threshold Low			1.5 V
Input Threshold High	3.5 V		
Output Current			5 mA
1PPS when set to 5 V			
Output Voltage Low	0 V		0.3 V
Output Voltage High	4.5 V		5 V
Output Current			50 mA
GPIO when set to 3.3 V			
Output Voltage Low	0 V		0.3 V
Output Voltage High	3 V		3.3 V
Output Current			5 mA
Input Voltage	-5 V		5 V
Input Threshold Low			0.8 V
Input Threshold High	2 V		
1PPS when set to 3.3 V			
Output Voltage Low	0 V		0.1 V
Output Voltage High	3 V		3.3 V
Output Current			50 mA
Alarm Output			
Voltage			36 V
Current			0.5 A
On Resistance			2.5 ohms

Table 16: Electrical Specifications

6.6 Ethernet Connection

Advanced Navigation offers a 3 m industrial Ethernet cable with a MIL-DTL-38999 Series III connector to create a rugged connection to the unit. This is supplied as part of the [3 Evaluation Kit](#), and also a recommended accessory with the standalone unit. The MIL-DTL-38999 Series III RJ45 end is IP67 rated in mated position.

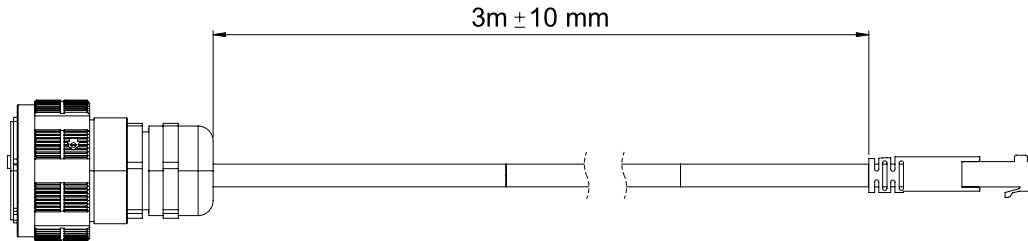

Figure 8: Ethernet Cable

There are several alternatives and options for differing application needs:

- If a shorter cable is required, it can be either coiled or cut and re-terminated.
- For evaluation purposes, a standard Cat5e or better Ethernet cable can be used directly into the unit.
- If a longer cable is required, a standard Cat5e or better cable can be used with an Amphenol RJF-TV series connector. This connector uses a MIL-DTL-38999 Series III mating connection in a size 19. The connector has a normal Orientation Key, and is finished in an RoHS-compliant Black Zinc Nickel finish for high corrosion resistance. Refer to Amphenol documentation for instructions on how to correctly terminate these connectors.

Connector	Manufacturer and Series	Part Number	Notes	Finish
Cable side Ethernet connector	Amphenol Socapex	RJF TV 6M ZN	Aluminium, Straight Plug with metal gland, Size 19	Black Zinc Nickel

Table 17: Ethernet Connector

6.7 IO Connection

The IO connection is used to provide the power supply and access to a range of interface connections. It can be achieved with an [6.7.1 IO Unterminated Cable](#), an [6.7.2 IO Breakout Cable](#) or by building your own cable (see [6.7.3 Custom IO Termination](#)). Connection is made through MIL-DTL-38999 Series III connectors, which provide reliable and rugged connection under demanding conditions and are rated to IP67 in the mated position (see [7.5 MIL-DTL-38999 Series III Connector Mating](#)).

6.7.1 IO Unterminated Cable

An optional 5 m unterminated cable is available for custom connections. Each individual wire in the unterminated cable is a colour-coded FEP coated wire. See [Pin](#) for details on pin out functions. Custom cable lengths for unterminated types are available subject to minimum order quantities and lead times; contact the [Sales](#) team for more information

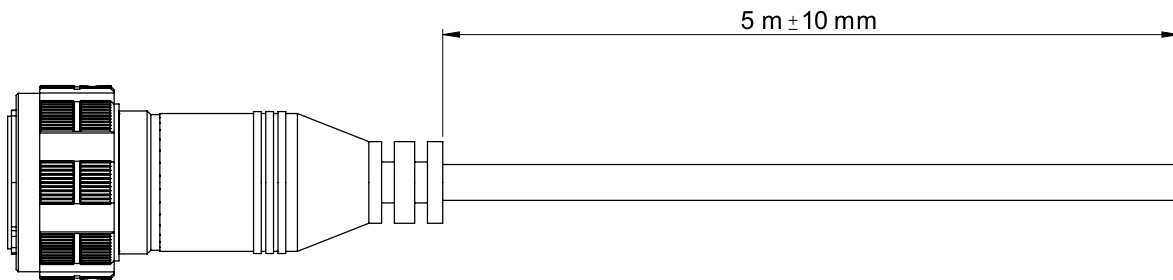

Figure 9: IO Unterminated Cable

Pin	Colour	Function
A	Black	Power Ground
B	Red	Power Supply
C	Orange	1PPS
D	Blue	GPIO1
E	Brown	GPIO2
F		
G	Violet	RS422-TX(+)/RS232-TX PRI
H	Yellow	RS422-RX(+)/RS232-RX PRI
J	White	Serial Ground 1
K	Light Blue	RS422-TX(+)/RS232-TX AUX
L	Light Green	RS422-RX(+)/RS232-RX AUX
M	White/Red Stripe	Serial Ground 3
N	Light Brown/Black Stripe	CAN H
P		
R		
S	Pink	Alert H
T	Pink/Black Stripe	Alert L

Pin	Colour	Function
U		
V	Grey	GPIO Ground 1
W	Grey/Black Stripe	GPIO Ground 2
X	Grey/Red Stripe	GPIO Ground 3
Y	Violet/Black Stripe	RS422-TX(-) PRI
Z	Yellow/Black Stripe	RS422-RX(-) PRI
a	Light Blue/Black Stripe	RS422-TX(-) AUX
b	Light Green/Black Stripe	RS422-RX(-) AUX
c	Light Brown	CAN L
d		
e		
f	Brown/White Stripe	NA
g	Blue/White Stripe	NA
h	White/Black Stripe	Serial Ground 2
j	Orange/Black Stripe	NA

Table 18: Pin Allocation Table

6.7.2 IO Breakout Cable

Advanced Navigation offers a 2 metre long pre-terminated IO cable that is supplied as part of the Boreas [3 Evaluation Kit](#). Custom cable lengths are not available for pre-terminated cables.

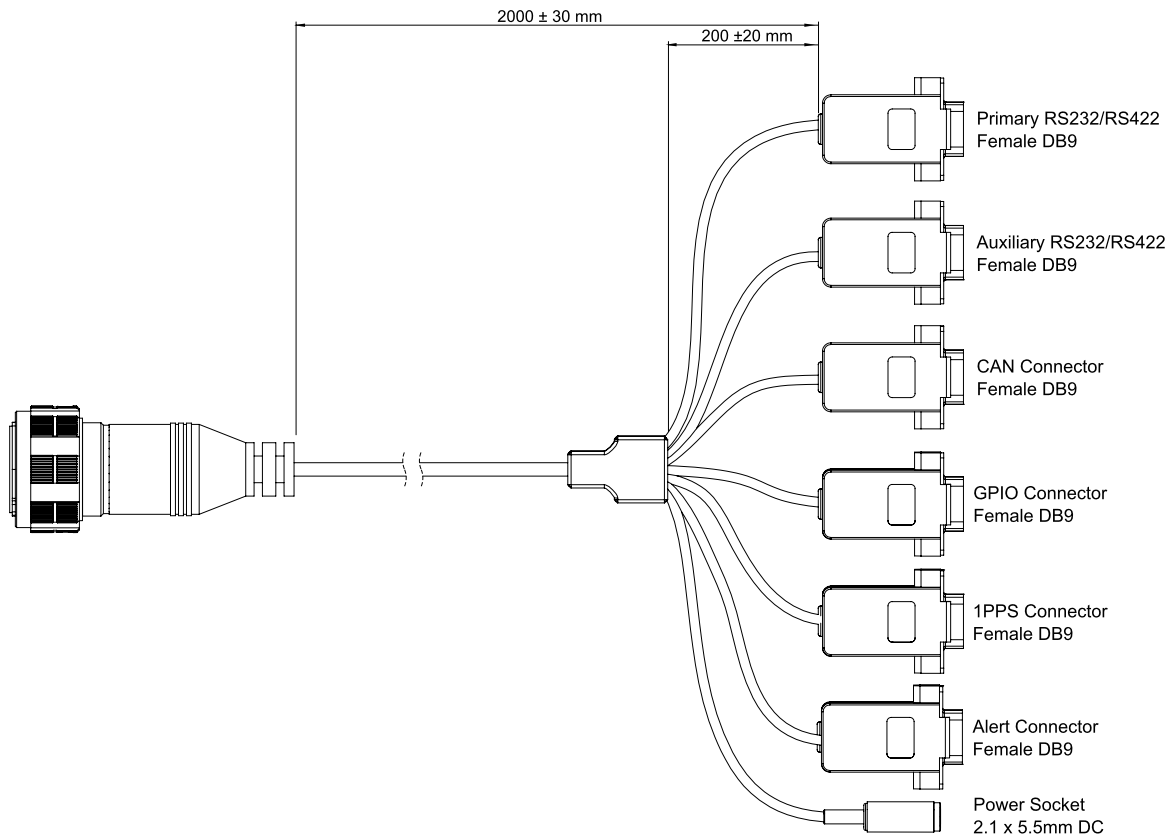

Figure 10: IO Breakout Cable

The IO breakout cable comprises one DC barrel plug for power, and six DB9 connectors that allow connecting to:

- Primary RS232/RS422
- Auxiliary RS232/RS422
- CAN Connector
- GPIO Connector
- 1PPS Connector
- Alert Connector

Given below are details of the IO breakout cable connections.

Pin	Function	Primary	Auxiliary	CAN	GPIO	1PPS	Alert	Power
A	Power Ground							Ring
B	Power Supply							Tip
C	1PPS					2		
D	GPIO1				2			
E	GPIO2				3			
F								
G	RS422-TX (+)/RS232-TX PRI	2						
H	RS422-RX (+)/RS232-RX PRI	3						
J	Serial Ground 1	5						
K	RS422-TX (+)/RS232-TX AUX		2					
L	RS422-RX (+)/RS232-RX AUX		3					
M	Serial Ground 3			6				
N	CAN H			7				
P								
R								
S	Alert H						2	
T	Alert L						3	
U								
V	GPIO Ground 1					5		
W	GPIO Ground 2				5			
X	GPIO Ground 3							
Y	RS422-TX(-) PRI	8						
Z	RS422-RX(-) PRI	7						
a	RS422-TX(-) AUX		8					
b	RS422-RX(-) AUX		7					
c	CAN L			2				
d								
e								
f	NA							

Pin	Function	Primary	Auxiliary	CAN	GPIO	1PPS	Alert	Power
g	NA							
h	Serial Ground 2		5					
j	NA							

Table 19: IO Breakout Cable Connector Pin-out

6.7.3 Custom IO Termination

Whilst it is recommended to use either a breakout cable or an unterminated cable from Advanced Navigation, you can also source and build your own custom IO cable.

A suitable IO MIL-DTL-38999 Series III connector is available from several manufacturers with a variety of different cable boot and strain relief options. The table below specifies suitable example connectors.

Connector	Manufacturer and Series	Part Number	Notes	Finish
TV-CTV MIL-DTL-38999 Series III, Size 19 connector with 32 size 20 contacts	Amphenol	TV O6 ZNCI 19-32 S A F472	Aluminium, Plug with integrated Backshell, Size 19-32 (32 x 20 gauge contacts), Socket contact, A orientation key	Black Zinc Nickel
	Souriau	8DA519Z32SA	Aluminium, Plug with integrated Backshell, Size 19-32 (32 x 20 gauge contacts), Socket contact, A orientation key	

Table 20: Cable Side IO Connector

7 Installing Boreas

To install and quickly get started with Boreas, follow the instructions provided in [7.1 Installation Checklist](#). Additional information related to installing Boreas is provided in the following sections:

See	For
7.2 Mounting Boreas	Guidelines for selecting the mounting location for the unit.
7.3 Mounting Alignment	Guidelines on setting the alignment with respect to the vehicle.
7.4 Cable Bend Radius	Recommendation on the bend radius of Advanced Navigation supplied cables.
7.5 MIL-DTL-38999 Series III Connector Mating	Information on correctly mating a connector
7.6 Power Supply	Recommendations for setting up power supply.
7.7 Electrical Domains	Information on how to minimise interference due to noise.
7.8 Networking	Information about changing Boreas to a fixed IP address system after establishing a connection.
7.9 Odometer	Different options using an odometer to improve the navigation and orientation.
7.10 Magnetics	Information on the effects of magnetic interference.
7.11 Vibration	Steps to mitigate the adverse effects of vibration on the performance.

Table 21: Additional Information

Note: For ordering an evaluation kit, a standalone kit or accessories for Boreas, see [5 Part Numbers and Ordering](#).

7.1 Installation Checklist

The following checklist provides the basic steps for connecting, mounting and configuring a Boreas unit.

1. Plug the power supply into the power connector on the IO breakout cable and then into the wall socket. See [7.6 Power Supply](#).
2. Plug the IO breakout cable into the IO connector on the Boreas unit. See [6.7 IO Connection](#) and [7.4 Cable Bend Radius](#).
3. Connect to Boreas using one of the following methods:
 - a. **Ethernet**
 - i. Connect either the MIL-DTL-38999 Series III terminated cable or a standard Cat5e Ethernet cable from the Ethernet socket on the Boreas unit to your network or switch. A standard Ethernet cable will not be IP67 rated, and using the cable may cause damage to the unit due to environmental factors. See [6.6 Ethernet Connection](#) and [7.4 Cable Bend Radius](#)

- ii. If using Windows, download and install the Bonjour ZeroConf networking utility from the link <https://www.advancednavigation.com/Bonjour64.msi>.
- iii. In a web browser, navigate to <http://boreas.local>.

b. **RS232**

- i. Connect the USB to RS232 / RS422 adaptor cable to the Primary port and your computer. The factory default setting is RS232. Check that the mode switch is at the correct setting.
- ii. **Java 11 is required** to run Boreas Manager. Adoptium JRE 11 is the recommended Java installer to be used on all platforms. Install the latest version of Java 11 from [Adoptium](#), selecting the correct operating system and architecture for your computer.
- iii. Download Boreas Manager from the [Boreas](#) product page of the Advanced Navigation website.

Note: Boreas Manager is only available for systems with x64 architecture

- iv. Double click Boreas Manager to start the application. See [Using Boreas Manager](#) for specific notes for different platforms
 - v. Select the correct COM port.
 - vi. Select the Baud Rate. The default baud rate is 115200 bps.
 - vii. Click **Connect**. If you are unable to connect, see [9.2.4 Troubleshooting](#).
4. Mount the unit in the standard alignment of X+ pointing forward and Z+ pointing down. For more information, see [7.3 Mounting Alignment](#).
 5. Choose a Vehicle Profile in the [9.1.3.1 Filter Options](#) screen under the **Configuration** menu. This should be the closest available match to your vehicle type. If you need more information, contact Support at support@advancednavigation.com.
 6. Check that all filters are initialised. See [8.1 Filter Initialisation](#).
The system is now ready for use.

7.2 Mounting Boreas

When installing Boreas into a vehicle, the mounting position and [alignment](#) of the unit are essential for achieving optimal performance. Position refers to the physical location within the vehicle where the unit is installed while alignment refers to the orientation of the unit with respect to the orientation of the vehicle.

When planning a mounting location for Boreas, be mindful of the following recommendations.

- Mount the unit in an area that will not exceed the rated temperature range, and with minimal temperature fluctuations.
- Mount the unit away from high levels of vibration where possible.
- Mount close to the centre of gravity of the vehicle where possible.
- Mount the unit at least 10 cm away (and preferably as far as possible) from sources of dynamic magnetic interference such as high current wiring or large motors for best performance.
- Do not obstruct the two vents on the side of the enclosure unless [8.7 Atmospheric Altitude](#) will be disabled.

Boreas is mounted using the four 4.4 mm diameter mounting holes on the base of the enclosure (see [Figure 11: Bottom View of Boreas Mounting Plate](#) below for mounting plate and hole guide).

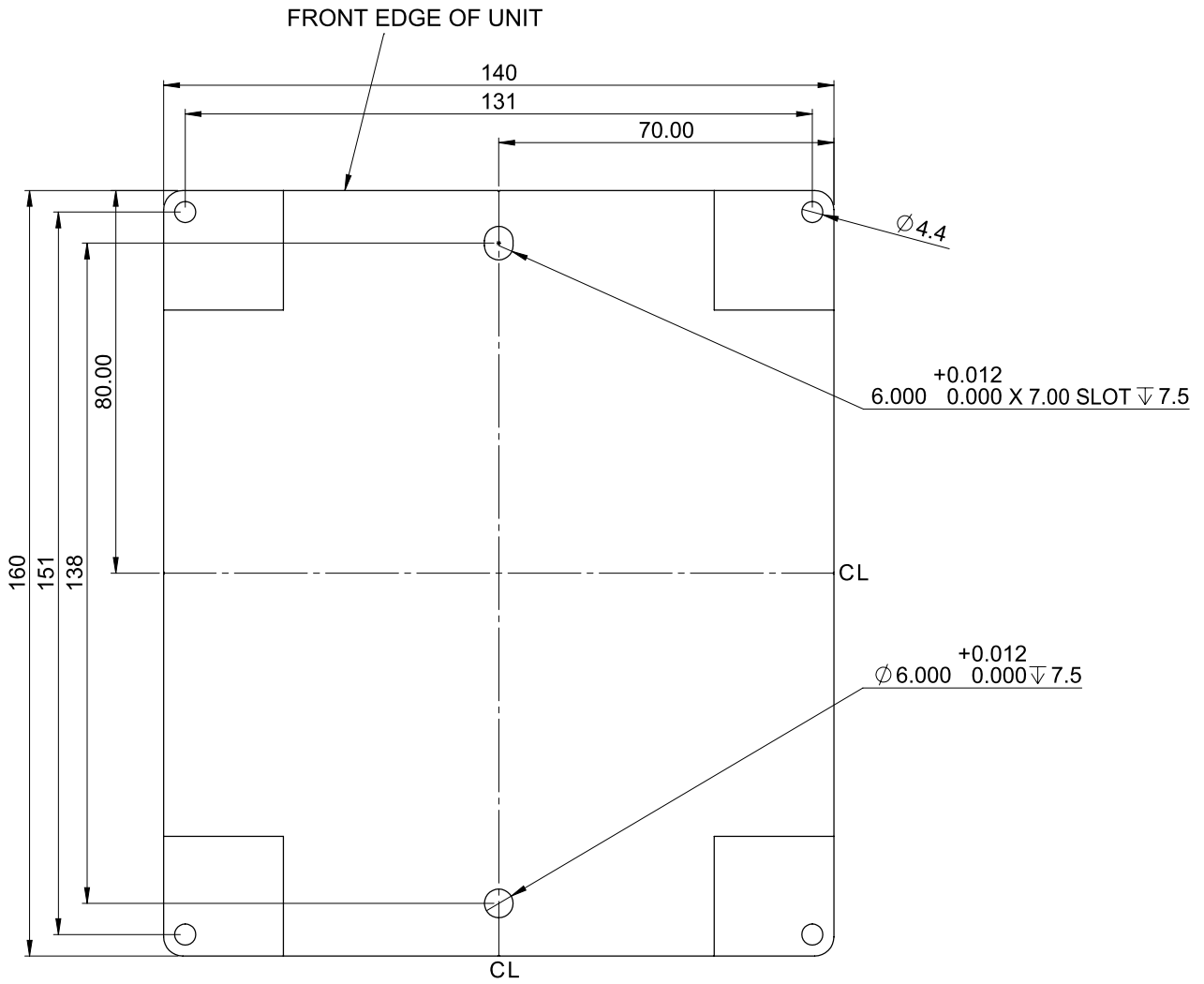

Figure 11: Bottom View of Boreas Mounting Plate

For precision mounting, an alignment hole 6 mm and an alignment slot 6 mm x 7 mm are provided at the middle edge of the enclosure. They are designed for 6 mm dowel pins. Suitable alignment dowel pins based on DIN 6321 are Norelem Locating Pin 02020-206 or equivalent.

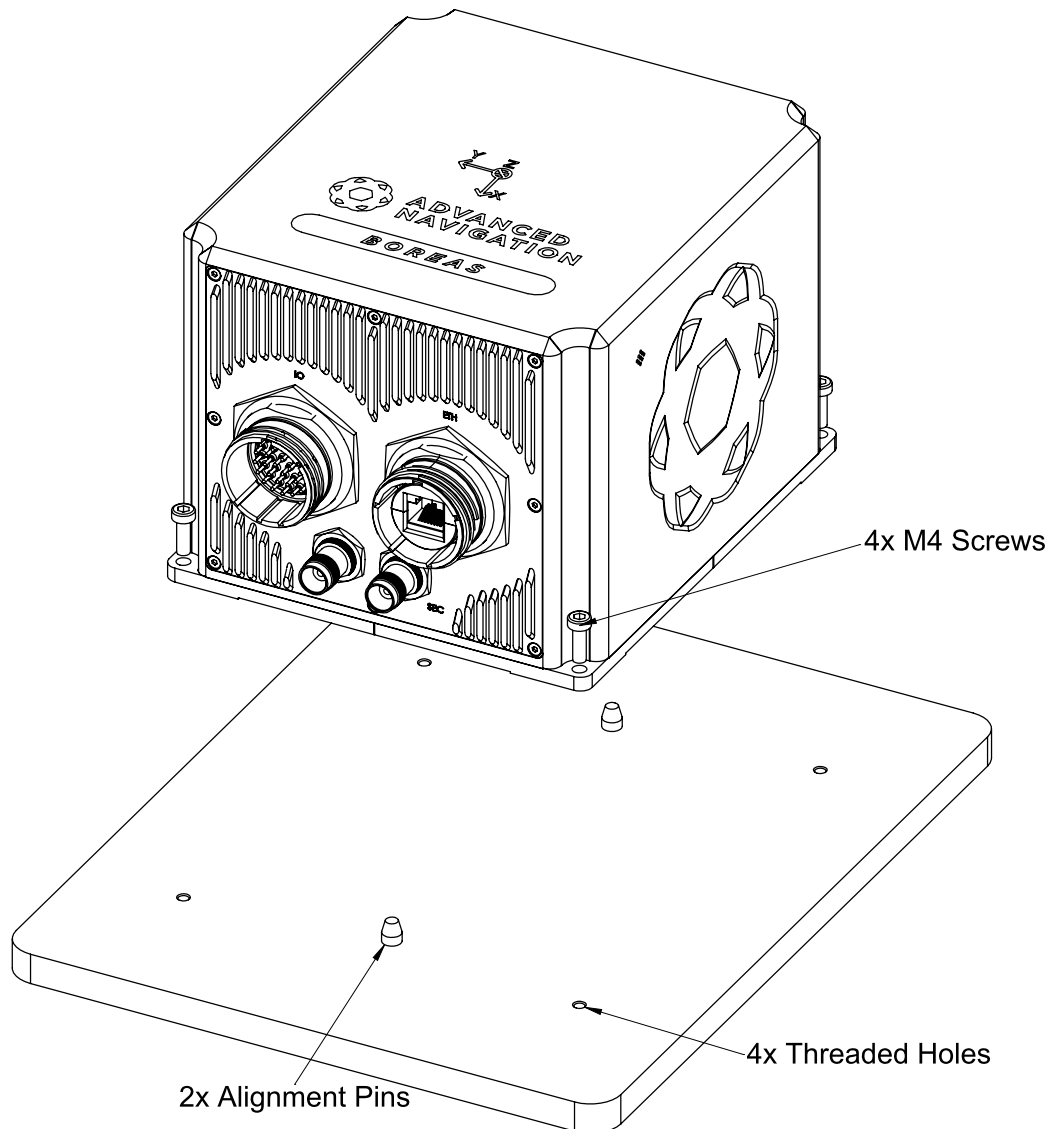

Figure 12: Boreas Mounting Holes and Alignment Pins

It is recommended that M4 stainless steel washers with an outside diameter of 9 mm are used under the bolts. Blue loctite can also be used to prevent the screws from loosening over time.

To ensure precision mounting repeatability,

1. Place the unit in position on the alignment pins and apply gentle pressure in the positive y-axis direction.
2. Install the M4 mounting screws.
3. Tighten the stainless steel bolts in a clockwise direction to a torque of 1 Nm.

For instructions on alignment of the unit within a vehicle, see [7.3 Mounting Alignment](#).

7.3 Mounting Alignment

The easiest way to align Boreas is by installing the unit with its sensor axes aligned with the vehicle axes. There are notches marked on the unit to indicate the X and Y axes to assist with alignment.

Install the unit such that the X+ axis points forward towards the front of the vehicle and the Z+ axis points straight down towards the ground as shown below.

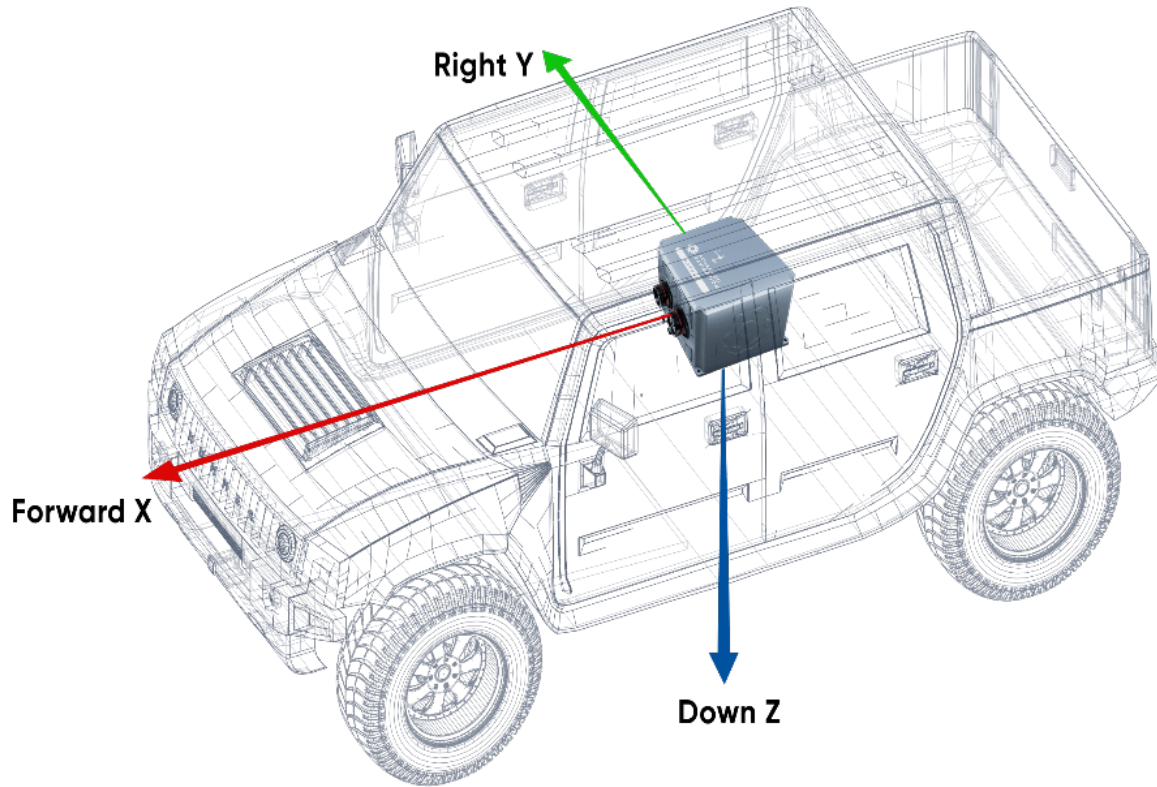

Figure 13: Recommended Mounting Location and Alignment

If aligning Boreas with the vehicle axes is not possible within vehicle size or shape constraints, it may be mounted in a different alignment and the alignment offset can be configured [9.1 Using the Web User Interface](#) or [9.2 Using Boreas Manager](#).

7.4 Cable Bend Radius

During installation, be mindful that cables must not be flexed beyond their specified bending radius. For Advanced Navigation supplied cables, these specifications can be found in [6.2.3 Cable Bend Radius](#).

A figure of the bend radius for Advanced Navigation supplied cables is shown below.



Figure 14: Bend Radius Using Advanced Navigation Supplied Cables

For space-constrained applications, it may be necessary to use single-insulated wires with a customer-supplied plug.

7.5 MIL-DTL-38999 Series III Connector Mating

In order to maintain proper ingress protection, it is important that a proper connection is made to the MIL-DTL-38999 Series III IO and Ethernet connectors.



Figure 15: Unmated Connector



Figure 16: Correctly Mated Connector

The connector should be mated using its correct keying position and orientation. The screw thread should be tightened to fully mated position. If using an Advanced Navigation supplied cable, a visible red band indicates that the connector is not mated correctly. See [8.14 Environmental Exposure](#)

7.6 Power Supply

A high level of power supply filtering has been built into Boreas to allow for reliable operation in demanding environments. However, a power supply with low noise and ripple levels, and adequate transient response is still recommended. Boreas contains a fully isolated power supply and has separate grounds for power and signals to ensure that power supply noise does not corrupt communications or cause ground loops with other equipment. See [7.7 Electrical Domains](#) for more details about isolation.

The power supply must be able to reliably provide the maximum current at the chosen voltage, especially in systems with substantial load variations. Make sure that all system components are rated (including safety factors) for the anticipated environmental operating conditions and stressors of the system. Refer to section [6.2 Hardware Specifications](#) for further information.

Boreas contains an active protection circuit on the power supply input that protects the unit from under-voltage, over-voltage and reverse polarity events. It is recommended to always operate the unit at a voltage higher than the minimum mentioned in the Boreas [6.5 Electrical Specifications](#). Take caution when using a supply voltage close to the minimum voltage as minor voltage fluctuations could trigger under-voltage protection, leading to unexpected oscillations between the on and off states.

7.7 Electrical Domains

Boreas contains separate electrically isolated domains. Each domain is isolated from the others to minimise noise injection and avoid ground loops. Where possible, this isolation should be preserved by externally connected devices. We recommend connecting the enclosure to your vehicle ground where possible for the best electrical noise performance.

Domain Name	Affected Components and Ports
Chassis	Enclosure
Power	Power Supply
Serial	Primary port, Auxiliary port, CAN port
GPIO	GPIO 1 port, GPIO 2 port, 1PPS port
Ethernet	Ethernet port

Table 22: Boreas Electrical Domains

7.8 Networking

The default configuration for Boreas is for the DHCP Client to be Enabled. This makes it a plug-and-play solution for most users. It is possible to change Boreas to a fixed IP address system once a connection has been established.

Boreas supports the Zero Configuration (Zeroconf) networking feature. On Linux and MacOS systems no additional software is required. If you are using Microsoft Windows, install the Apple Bonjour software from <https://www.advancednavigation.com/Bonjour64.msi> if it's not already installed. Open a web browser and type in the address <http://boreas.local/> to discover the device and access the web interface.

If you cannot establish a connection using a DHCP-capable network, you can connect to and configure the Boreas using the Primary port RS232 serial interface and the Boreas Manager application.

Note: A factory reset will re-enable the DHCP Client and lose any static IP address settings.

7.9 Odometer

Note: Boreas AHRS variants can be upgraded to full INS capability through a software license upgrade. Position and navigation functionality is only to be used when licensed as an INS. As an INS it can be interfaced to any leading brand of GNSS receivers to create an OEM GNSS/INS solution.

On ground vehicles, the use of an odometer input will greatly improve the Boreas navigation and orientation solution.

There are several different options for odometer that are explained as follows.

7.9.1 Factory VSS Signal

Most mass-market vehicles since 1980 contain a VSS (vehicle speed sensor) signal that can be wired directly into one of the Boreas GPIO pins. Any voltage limits on this pin that must be taken into consideration.

To set up the odometer, the appropriate GPIO pin should be set to Odometer Input using Boreas Manager. The odometer pulse length must then be set either manually or automatically, see [8.8 Odometer Pulse Length](#) for more information.

For more information on the GPIO signals and their requirements see [10.6 GPIO Pins and the Auxiliary Port](#).

7.9.2 OBDII Odometer Interface

For applications where it is undesirable to modify the vehicle or the system needs to be used with multiple vehicles, the OBDII odometer interface may be a better solution. OBDII is a vehicle diagnostic port standard and most vehicles from the mid 1990s onwards contain an OBDII port in the drivers side foot well. Advanced Navigation produces an inexpensive OBDII Odometer Interface that plugs into this OBDII port and feeds Boreas with odometer data over the Auxiliary RS232 port. See the figure below. Contact the Advanced Navigation sales team at sales@advancednavigation.com for more information.



Figure 17: Advanced Navigation OBDII Odometer

7.9.3 Aftermarket Wheel Speed Sensor

Applications requiring very high performance without GNSS for any length of time are recommended to use a high precision aftermarket wheel speed sensor. Advanced Navigation recommends aftermarket wheel speed sensors from Kistler, Pegasem or GMH Engineering.



Figure 18: Aftermarket Wheel Speed Sensor

7.9.4 Radar Speed Sensor

For applications requiring high performance in harsh conditions where aftermarket wheel speed sensors are not feasible, a radar speed sensor is recommended. Advanced Navigation recommends radar speed sensors from Stalker or GMH Engineering.



Figure 19: Radar Speed Sensor

7.10 Magnetics

Boreas uses FOG sensors to calculate heading; therefore, its heading is not corrupted by stray and changing magnetic fields. However, FOG sensors can still be affected by magnetic fields, which are strong and in close proximity. It is recommended that Boreas is not mounted directly on or closely adjacent to electric motors, solenoids and high current pulsed wiring. Magnetic Fields stronger than 2 Gauss at the surface of the unit will effect performance.

7.11 Vibration

Boreas is able to tolerate a high level of vibration compared to other inertial systems. This is due to a unique gyroscope design and a special filtering algorithm among other things. There is, however, a limit to the amount of vibration that a unit can tolerate — temporary degradation in accuracy may occur while operating under high vibration.

When mounting Boreas to a platform with vibration present, there are several options to mitigate the negative performance effects. It is recommended to conduct a brief operating check to confirm performance is within specification before conducting longer runs. The Raw Sensor view in the web UI or Boreas Manager can give you a good idea of how bad the vibrations are.

If there are persistent issues:

- Try to find a mounting point with less vibration.
- Boreas can be mounted with a small flat piece of rubber to provide some isolation. This must not be very soft foam which may result in an incorrect level over time.
- Mount Boreas to a plate which is then mounted to the platform through vibration isolation mounts. Be mindful that a plate with very soft mounts may also cause problems with shifts in orientation over time.

8 Using Boreas

This section covers the following topics:

- [8.1 Filter Initialisation](#)
- [8.2 Hot Start](#)
- [8.3 Time](#)
- [8.4 Heading Sources](#)
- [8.5 Data Anti-aliasing](#)
- [8.6 Vehicle Profiles](#)
- [8.7 Atmospheric Altitude](#)
- [8.8 Odometer Pulse Length](#)
- [8.9 Reversing Detection](#)
- [8.10 Motion Analysis](#)
- [8.11 Kinematica Post Processing](#)
- [8.12 Vents](#)
- [8.13 Vessel Motion](#)
- [8.14 Environmental Exposure](#)
- [8.15 Upgrading the Boreas Firmware](#)

8.1 Filter Initialisation

There are four different levels of filter initialisation on Boreas. These are orientation, navigation, heading and time.

The initialisation of each can be monitored by inspecting the [9.1.2.3 Status](#) view in the web UI or [9.2.6 View Menu](#) in the Boreas Manager.

Initialisation

- Orientation
- Navigation
- Heading
- Time

Figure 20: Initialisation Levels

After all four levels of initialisation, the Boreas INS filter takes several minutes to achieve its full accuracy. It is recommended to wait two minutes after initialisation for applications requiring high accuracy.

8.1.1 Orientation Initialisation

Orientation initialisation occurs automatically upon power on and typically completes within seconds. To determine its orientation it uses the accelerometers to measure the gravity vector. Random accelerations from environmental sources can disturb this process, which can introduce minor orientation errors that will be corrected within several seconds. To prevent this, Boreas monitors the accelerometers and gyroscopes and restarts the orientation detection if there are sudden movements. It is however still possible under some circumstances for it to miss minor movements and start with a small orientation error. Boreas will progressively correct the orientation error over a period of several seconds.

Once orientation initialisation is complete, the roll, pitch and angular velocity values will be valid.

8.1.2 Navigation Initialisation

Note: Boreas AHRS variants can be upgraded to full INS capability through a software license upgrade. Position and navigation functionality is only to be used when licensed as an INS. As an INS it can be interfaced to any leading brand of GNSS receivers to create an OEM GNSS/INS solution.

Navigation initialisation completes once the system has determined a starting absolute position. If the system is hot-starting it will remember its position at the time it was switched off and use this as the starting position. The other possibility for navigation initialisation is an external position source to be used, see [11.4.25 External Position Packet](#) for more information. In a situation where an external position input is not available, it can be initialised manually by entering a position into the [9.1.3.8 Manual Initialisation](#) page in the web UI or the [9.2.7.11 Manual Initialisation](#) dialogue in the Boreas Manager.

Once navigation initialisation is complete, the position, velocity and acceleration values will be valid.

8.1.3 Heading Initialisation

Heading initialisation completes once the system has determined a heading using one of its several methods. The conditions required to determine a heading depend upon the heading source being used, see [8.4 Heading Sources](#). If velocity heading is enabled and the vehicle is moving, this will be very fast. If the system hot-starts, the last known heading value will be used. However, in order for the Heading Filter to initialise, the system must have a valid heading source.

Until the heading has been initialised, the system will not be able to navigate without a GNSS fix, and the roll and pitch values will not reach full accuracy.

8.1.4 Time Initialisation

Time initialisation completes once the system has determined time accurately. For this to occur the system must receive rough time as well as a 1PPS signal on one of the GPIO pins. It is also possible to acquire time from an external source, see [11.4.31 External Time Packet](#) for more information.

Until the time has initialised, the Unix or formatted time that Boreas outputs will be flagged as invalid.

8.2 Hot Start

Advanced Navigation devices were the first on the market with hot-start functionality. This hot-start functionality allows Boreas to start inertial navigation within 500 ms to 2s. The hot-start functionality is always on and fully automatic. See [Navigation Specifications](#) for details.

A next generation backup battery system within Boreas provides the hot-start ability for more than 48 hours without power. When Boreas hot-starts, it assumes that it is in the same state it was when it lost power and begins navigating from that position.

Whenever Boreas is without power it continues to accurately keep time so that it is immediately valid for a hot-start.

The hot-start functionality is of particular benefit to vehicle tracking and robotics applications. The primary benefits are immunity and fast recovery from power failure as well as fast start up time.

8.3 Time

Boreas has been designed to provide a highly accurate time reference. It contains a temperature compensated disciplined oscillator that corrects itself very precisely using GNSS time. When a GNSS fix is available, the Boreas time is accurate to within 20 nanoseconds.

If greater accuracy is required for your application, Advanced Navigation may be able to offer Boreas with a temperature compensated disciplined oscillator that has greater time accuracy than 20 nanoseconds and less than 3 $\mu\text{s/hr}$ of drift. Contact Advanced Navigation's sales department at sales@advancednavigation.com for more information.

When Boreas hot-starts the time accuracy is typically within 1-2 seconds immediately on startup and corrected to within 50 nanoseconds as soon as a GNSS fix is achieved.

The time can be accessed via the following means:

- A 1PPS output over GPIO or the Auxiliary port, see [10.6.1.2 1PPS Output](#) of the Dynamic Pin Functions.
- A built-in Precision Time Protocol (PTP) version 2 server for synchronisation with network-connected devices which require high accuracy time. The PTP server broadcasts PTP messages (Sync, Follow Up, Announce) to multicast IP address 224.0.1.129. The PTP broadcasts are sent whenever an Ethernet connection is established and cannot be disabled.

8.4 Heading Sources

There are several different heading sources available for Boreas. The heading sources can be configured using the **Filter Options** page in the Web UI (see [9.1 Using the Web User Interface](#)) or in the Manager application (see [9.2 Using Boreas Manager](#)). It is possible to use multiple heading sources and this can provide performance benefits.

8.4.1 North Seeking Gyrocompass Heading

Boreas contains high accuracy gyroscopes allowing it to detect the rotation of Earth to determine North with a high degree of accuracy. Gyrocompass heading is fully automatic and always enabled.

Coarse alignment takes two minutes to complete, during which time some movement is acceptable, however it is best to keep the unit as stationary as possible. The [9.1.2.10 Coarse Heading Alignment](#) Status dialogue in the Web UI provides feedback on the initialisation process.

Fine alignment will occur after coarse alignment is complete. Fine alignment is automatic, and the time taken to reach full accuracy will depend upon operating conditions. Some movement, ideally including 90 degree turns will speed up the time required to reach full accuracy.

For all applications, the gyrocompass heading requires an approximate position that is within a 50 km range. The position can come from the GNSS, [9.1.3.8 Manual Initialisation](#), or the last good position that is stored in flash memory.

8.4.2 Velocity Heading

Velocity heading works by deriving heading from the direction of velocity and acceleration. Velocity heading works well with cars, fixed wing aircraft and other vehicles that don't move sideways. Velocity heading cannot work for helicopters and other vehicles where the vehicle is pointed somewhere other than the direction of travel. Velocity heading requires a horizontal speed of over 1.15 m/s with a GNSS fix. Velocity heading is disabled by default.

8.4.3 External Heading

This can be used if there is some other way to derive heading that is external to Boreas. The heading must be supplied to Boreas using the [11.4.28 External Heading Packet](#) or an NMEA message, see [10.6.1.28 NMEA Input](#).

8.4.4 External Magnetometers Packet

Heading can be derived using the magnetometers of an additional external Advanced Navigation product to input external magnetometer values. See [External Magnetometers Packet](#) for details.

8.5 Data Anti-aliasing

Internally the Boreas filters update at 1,000 Hz. When Boreas outputs data, most applications require the data at a much lower rate (typically less than 100 Hz). This causes a problem for time-based data such as velocities and accelerations where aliasing will occur at the lower rate. To prevent this problem, if the output rate is lower than 1000 Hz, Boreas will low-pass filter the values of the time dependent data between packets to prevent aliasing. This is only the case when a packet is set up to output at a certain rate. If the packet is simply requested, no anti-aliasing will occur. Additionally there is no anti-aliasing for non time-dependent fields such as position.

8.6 Vehicle Profiles

Boreas supports a number of different pre-configured vehicle profiles. These vehicle profiles impose constraints upon the filter to increase performance. If your application matches one of the available vehicle profiles, it is required that you select it for use in the [Filter Options](#) page in the Web UI or Boreas Manager. For a list of the different vehicle profiles, see [11.5.5.1 Vehicle Types](#). If the wrong vehicle profile is selected, it can cause a significant decrease in performance.

8.7 Atmospheric Altitude

Boreas contains an internal atmospheric pressure sensor. This is used as an altitude aid in the filter. If Boreas is mounted in an area subject to unusual pressure waves, for example helicopters, or is mounted inside an enclosure that is not exposed to atmospheric pressure, the pressure sensor input should be disabled. This can be done by disabling Atmospheric Altitude in the [9.1.3.1 Filter Options](#) page in the web UI or the [9.2.7.2 Filter Options](#) dialogue in the Boreas Manager.

8.8 Odometer Pulse Length

For Boreas to use a wheel speed sensor or odometer input, it must know the pulse length of the signal. The pulse length is the distance in metres between low to high transitions of the signal. By default, the odometer will

automatically calibrate itself. To automatically calibrate the odometer pulse length, see [8.8.1 Calibrating Odometer Automatic Pulse Length](#).

8.8.1 Calibrating Odometer Automatic Pulse Length

1. Ensure that the signal is connected correctly and that the GPIO pin is configured as an odometer input using the [9.1.3.5 GPIO](#) page in the web UI or the [9.2.7.6 GPIO](#) dialogue in the Boreas Manager.
2. Open Boreas Manager, connect to Boreas and open the Odometer Configuration dialogue. In the **Odometer Configuration** dialogue select the **Automatic pulse length calibration** check box and click **Save**.
3. Wait until Boreas has a continuous GNSS fix from an external GNSS receiver and then conduct the test in an area with no obstructions over the test circuit.
4. If Boreas loses a GNSS fix for any extended period of time during the calibration, the distance travelled will be reset. The distance travelled can be checked in the Odometer Configuration dialogue to ensure that it has passed 1,000 metres.
5. Once 1000 metres has been driven, check that the automatic pulse length check box has become un-ticked and the Pulse Length value has changed. This indicates a successfully completed calibration.

Note: To enter the pulse length manually, use the [Odometer](#) page in the Configuration menu in the [Boreas Manager](#).

8.9 Reversing Detection

Reversing detection is an algorithm that can detect when the vehicle is travelling backwards. Knowledge of reverse motion is important when using velocity heading or odometer input to provide correct results. If Boreas is fitted to a vehicle that does not reverse or doesn't use velocity heading or an odometer, this function should be disabled. Reversing detection is enabled by default and it can be disabled using the Filter Options page in the web UI or Boreas Manager. See [9.1 Using the Web User Interface](#) or [9.2 Using Boreas Manager](#).

8.10 Motion Analysis

Motion analysis is an artificial intelligence algorithm that associates patterns in high frequency inertial data with the speed of the vehicle. After power on it takes some time to match patterns with speed before it will become active. Motion analysis only activates when dead reckoning and is most effective when the vehicle is near stationary. Motion analysis does not work in all situations and its primary benefit is for ground vehicles. It should be enabled in any car application. Motion analysis is enabled by default and can be disabled using the [9.1.3.1 Filter Options](#) page in the web UI or the [9.2.7.2 Filter Options](#) dialogue in the Boreas Manager.

8.11 Kinematica Post Processing

Boreas can be used with Advanced Navigation's post-processing platform Kinematica to achieve high-accuracy positioning of as low as 10 mm and significantly improved dead reckoning performance. You need to record a ANPP-format log file with certain packets enabled.

Refer to the Kinematica documentation found at www.advancednavigation.com/solutions/kinematica for details.

8.12 Vents

Boreas contains a sophisticated venting system that allows it to measure air pressure whilst preventing water ingress. There are two sets of vent holes on either side of the enclosure. It is very important that these remain clear of debris and blockages. Should debris get into the vents they should be gently rinsed with fresh water. Foreign bodies should never be poked into the vent holes, as this will break the environmental seal and void the warranty on the unit. The vents are not resistance to high-pressure jet washing or to waves. Do not direct streams of water directly at the unit.

8.13 Vessel Motion

Vessel motions are movements in the vertical and horizontal frames that are typically induced by wind, waves, turning and accelerating.

Boreas can provide position at four different points on a ship for heave, surge and sway respectively. The Boreas vessel motion filter is always on and fully automatic. After power on, Boreas requires approximately 5 minutes for its vessel motion filter to converge upon an accurate solution. Vessel motion works without a GNSS fix, however the best performance is achieved when Boreas has a GNSS fix from an external GNSS receiver.

By default Boreas provides heave, surge and sway from the point at which the Boreas unit is mounted, however it can provide vessel motion data at four different offset points on the ship. To configure Vessel Motion, see the [9.1.3 Configuration Menu](#) page in the web UI or use the [9.2.7.9 Reference Position Offsets](#) dialogue in the Boreas Manager.

8.13.0.1 Surge

Surge is the longitudinal (front-to-back) motion. Surge is outputted as a momentary position of the vehicle/vessel referenced to the mean position (the mean of the surge over a long period of time is always zero). Surge is measured positively forward along the X axis.

8.13.0.2 Sway

Sway is the transverse (side-to-side) motion. Surge is outputted as a momentary position of the vehicle/vessel referenced to the mean position (the mean of the sway over a long period of time is always zero). Sway is measured positively right along the Y axis.

8.13.0.3 Heave

Heave is the vertical (up/down) motion. Heave is outputted as a momentary position of the vehicle/vessel referenced to the mean position (the mean of the heave over a long period of time is always zero). Heave is measured positively down along the Z axis.

8.14 Environmental Exposure

Whilst Boreas is environmentally protected, there are limits to this protection that must be observed to avoid damaging the device.

Boreas is only IP67-protected when its connectors are mated (or sealed with the blanking caps). If any of these connections are not tightened to the recommended torque, the unit will not achieve its rated protection.

Spanners or tools should never be used to tighten the connectors. Use your fingers to firmly tighten the connectors. The Boreas seals the top of the enclosure to the base using screws and an o-ring. This o-ring is not field serviceable, and attempting to open the housing will invalidate the calibration.

8.14.1 Temperature

Boreas should not be subjected to temperatures outside of its operating range. Subjecting Boreas to temperatures outside of the operating range can affect the factory sensor calibration, potentially causing a permanent reduction in performance or premature failure. For information about the operating temperature range, see [6.2 Hardware Specifications](#).

8.14.2 Water

Boreas complies with IP67 standard, which means that it can be submersed in water to a depth of up to 1 m deep for a maximum of 30 minutes. Submersion to depths beyond 1 metre can cause water entry and destruction of the internal electronics, and the sealing is not designed for prolonged or repetitive immersion. Do not direct streams of water directly at the unit even at low pressure. For cleaning the unit, ensure that no pressure is used.

Note: Connectors must be installed or blanking caps must be used if the unit is likely to be exposed to water.

8.14.3 Salt

The Boreas housing is made from hard-anodized marine-grade aluminium and stainless fittings to provide good corrosion resistance, however cannot tolerate extended periods of time in salt water environments. After any contact with salt water or salt spray, Boreas should be rinsed with distilled or RO water.

8.14.4 Dirt and Dust

Boreas is completely sealed against dirt and dust entry whenever all connectors are mated. When disconnecting the connectors, any dirt or dust should be rinsed or wiped off with fresh water and then dried to minimise the chance of contaminants entering the connectors or plugs.

8.14.5 pH Level

Environments with acidic or alkaline water or atmospheres can cause the Boreas enclosure to corrode or discolor. If Boreas comes into contact with these environments it should be rinsed in fresh water as soon as possible. It is not recommended to operate Boreas in non-neutral pH environments.

8.14.6 Shocks

Boreas is a rugged piece of equipment that can withstand reasonable amounts of shock. However, continuous shocks may cause premature failure as a result of materials fatigue, and may also affect the sensor calibration resulting in degraded performance.

Shocks applied directly to the Boreas enclosure can affect the unit. Therefore, care should be taken when handling the unit prior to mounting. When mounted in a vehicle, the effect of most operating shocks is negligible.

8.14.7 Atmospheres

Hydrogen-rich atmospheres may damage the MEMS. Boreas is not rated for use where explosive gases or dust may be present.

8.15 Upgrading the Boreas Firmware

Boreas contains firmware which is regularly updated to improve performance and add features. Advanced Navigation recommends that you upgrade to the latest version whenever available. The firmware update function is robust, such that power loss, file corruption or other issues cannot cause problems with units. Check the [Boreas](#) product page of the Advanced Navigation website periodically for updates.

Note: Advanced Navigation device firmware files have the extension .anfw.

See [9.2.8.1 Firmware Update](#) for instructions on how to upgrade the firmware using the Boreas Manager or see [Firmware Update](#) for instructions to update the firmware using the web UI.

9 Configuring and Monitoring Boreas

Boreas can be configured and monitored through:

- the [web user interface](#), accessed on a connected computer via Ethernet
- Boreas [Manager](#), accessed on a computer via a serial adaptor
- the Advanced Navigation Packet Protocol ([9.4 Using ANPP](#))

The Boreas Web UI is the recommended interface to configure as it is designed to be simple and easy to use without any software or system requirements. The Web UI is compatible with all modern web browsers.

9.1 Using the Web User Interface

The web user interface allows you to manage Boreas through the following:

- [9.1.1 Main View](#)
- [9.1.2 View Menu](#)
- [9.1.3 Configuration Menu](#)
- [9.1.4 Tools Menu](#)

9.1.1 Main View

The Main View is accessible from other pages via the **Map** menu item under the **View** menu.

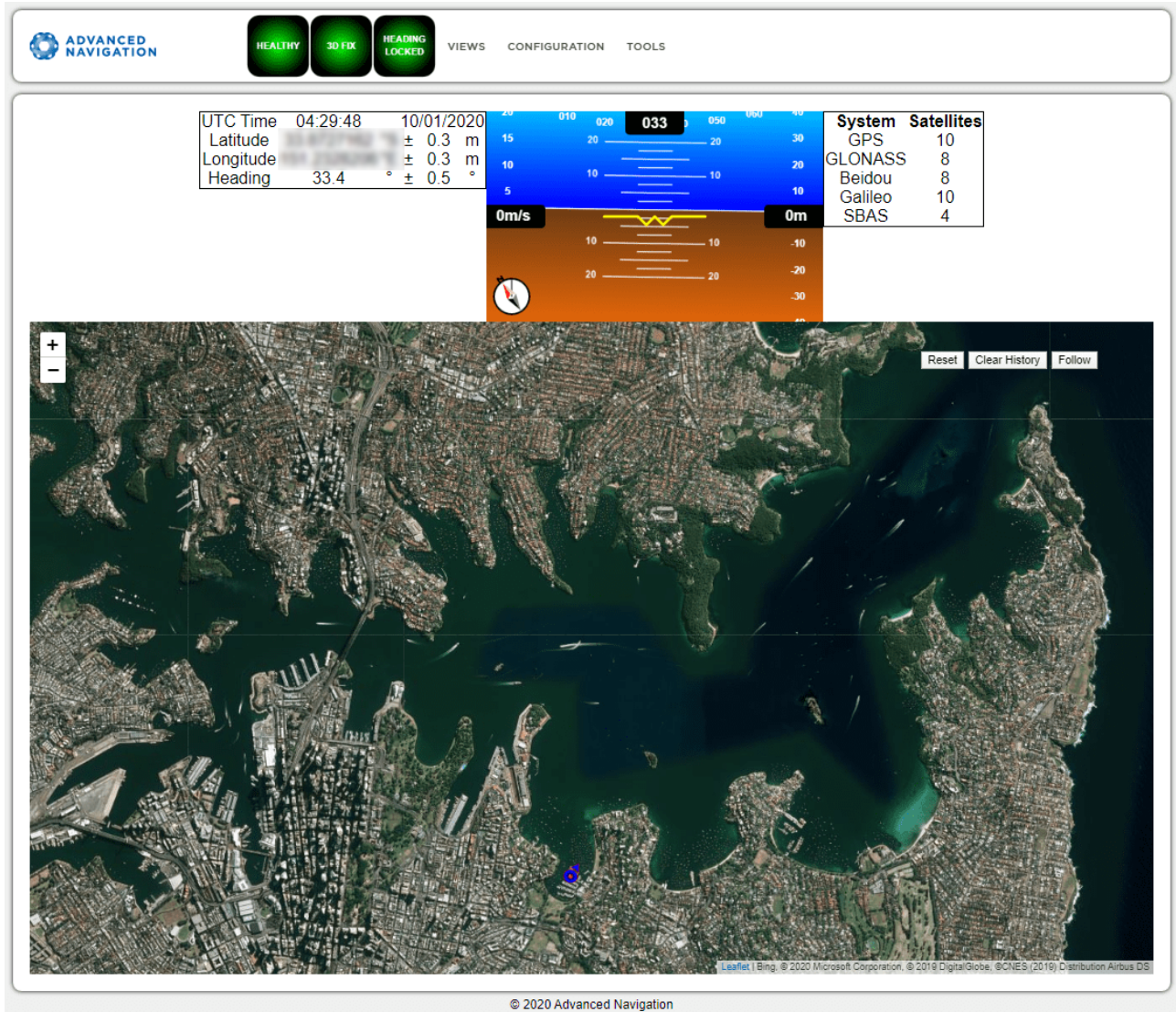

Figure 21: Boreas Web UI Home Page

9.1.1.1 Status Indicator

The Status Indicator section contains the current Boreas status and the heading status. These are visible on every page.

- **Status Indicator:** This indicator shows any problems with Boreas. Once the filter has initialised it will show "HEALTHY".
- **GNSS Fix:** This indicator shows the status of the GNSS fix. Under normal operating conditions it should show "3D FIX". When satellite visibility is poor it may show either "2D FIX" or "NO FIX".
- **Heading Status:** This indicator shows the current status of the heading filter. When there is a valid source of heading it will show "HEADING LOCKED".

9.1.1.2 Current Time, Position and Heading

This section displays the current UTC time, position, and heading. The data will only be valid if Boreas has a HEALTHY status, there is a 3D GNSS fix or better, and the Heading is initialised.

9.1.1.3 Altitude Indicator

The Attitude Indicator visualises roll and pitch using a standard artificial horizon. Heading, velocity and height are shown to the side. All units are SI (metric) and degrees.

9.1.1.4 Satellites Table

The Satellites table shows the number of satellites visible by the primary antenna. More detailed information can be found in the Satellites screen under the **View** menu.

Note: The satellites table will only display satellite data if the Boreas A90 or A70 has a license upgrade to full INS capability, and is interfaced to an external GNSS receiver.

9.1.1.5 Map

The map shows the Boreas position on Earth as well as a red trail showing position history since the last reset. When the filter initialises the map will automatically reset the view to the Boreas position. To move the camera click and drag on the map. To zoom in and out, use the mouse scroll wheel.

Use **Reset** to reset the map view to the current position of Boreas.

Clear History clears the current red trail showing the position history. This will immediately restart from the current position. Note that this does not affect any logging currently active.

9.1.1.6 Map Controls

Reset

This resets the map view to the current position of Boreas.

Clear History

This clears the current red trail showing the position history. This will immediately restart from the current position. Note that this does not affect any logging currently active.

Follow

This button makes the map follow the device.

9.1.2 View Menu

The View menu contains the options for viewing pages of data from Boreas.

9.1.2.1 Map

This takes the user back to the home page of the web UI with the map display.

9.1.2.2 Device Information

The Device Information page is useful for users when requesting technical support and for tracking their serial number, firmware version, and hardware version.



Figure 22: Boreas Web UI Device Information Page

9.1.2.3 Status

The Status shows the current status of Boreas as reported by sections [11.4.1 System State Packet](#) (ID#20) .

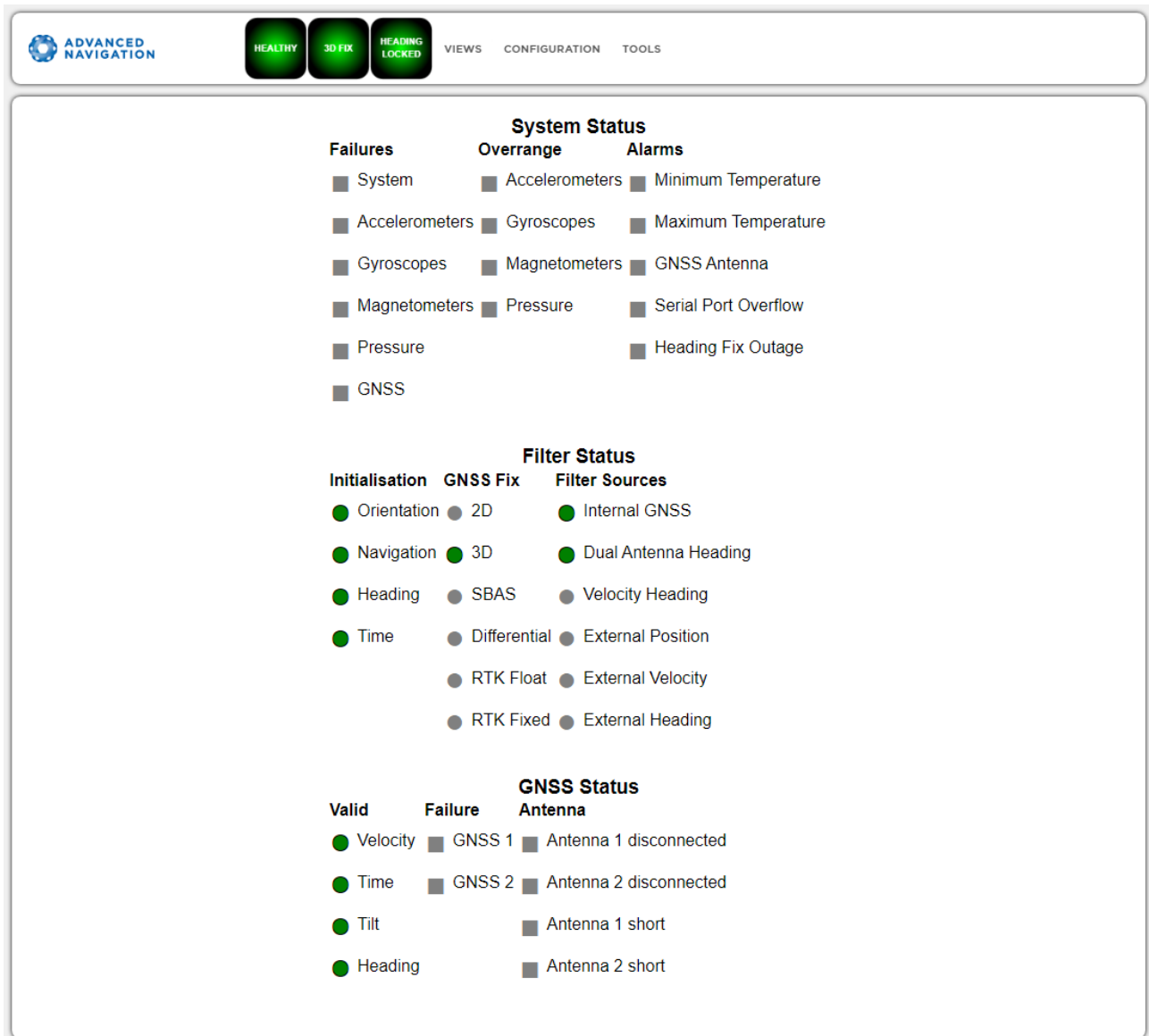

Figure 23: Boreas Web UI Status Page

9.1.2.4 Satellites

Note: The satellites page will only display satellite data if the Boreas A90 or A70 has a license upgrade to full INS capability, and is interfaced to an external GNSS receiver.

The information is displayed as a satellite skyplot, a table and an SNR graph. A maximum of 28 satellites will be displayed, even if more are accessible. This plot shows the SNR of each satellite at the primary and secondary antenna. As a guideline, these should be within 5-10 dB of each other in the absence of cable or antenna faults

Figure 24: Boreas Web UI Satellites Page

9.1.2.5 Raw Sensors

The Raw Sensors page shows the temperature-calibrated raw IMU sensor values. In the lower plot only the air pressure is plotted. The current value from the internal temperature sensors are given on the right. These do not provide general environmental temperature.

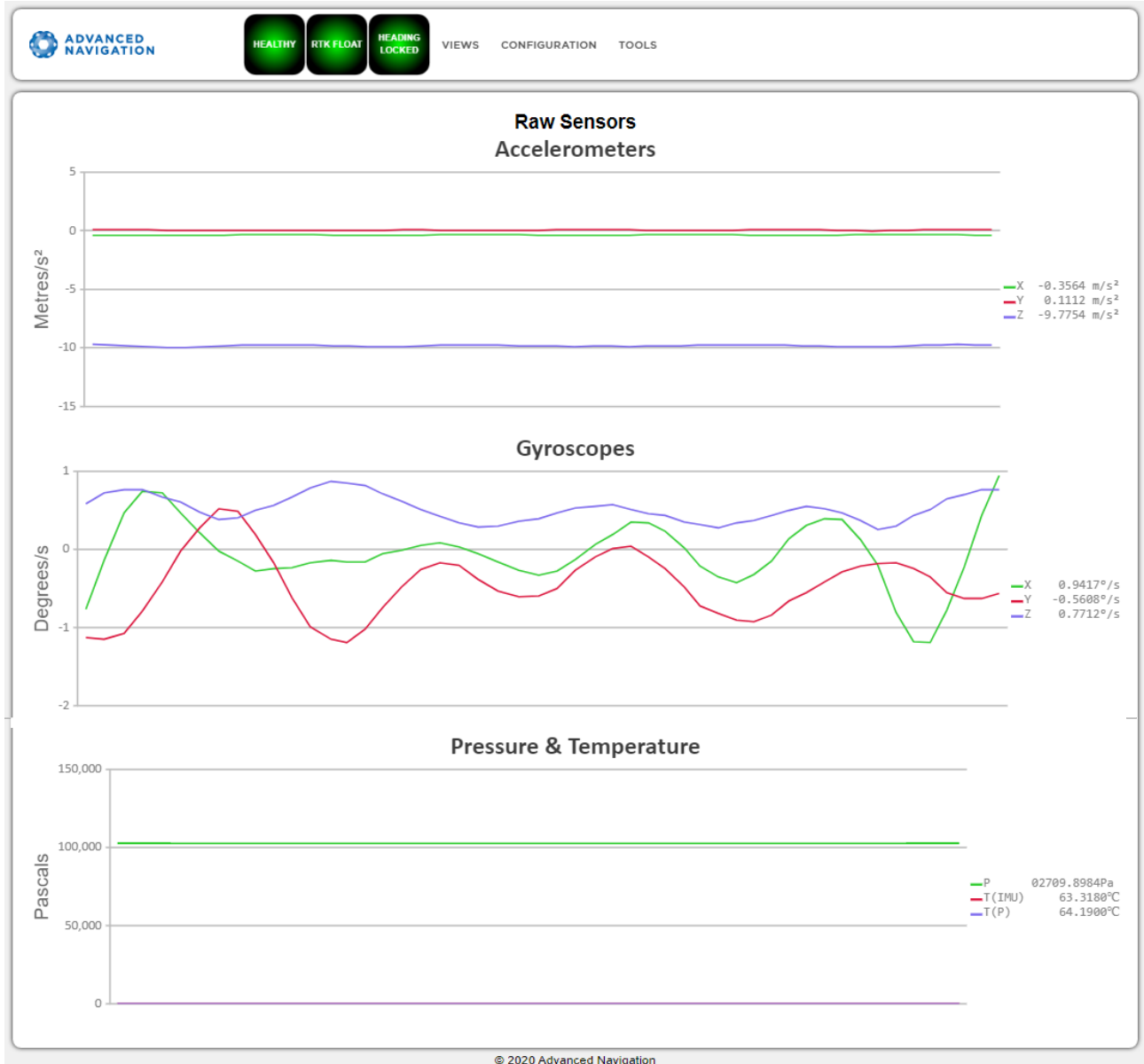

Figure 25: Web UI Raw Sensors Page

9.1.2.6 Orientation

The Orientation page shows the Boreas orientation and angular velocity. Course is determined by measuring sequential positions. Slip is the difference between the heading and the course.

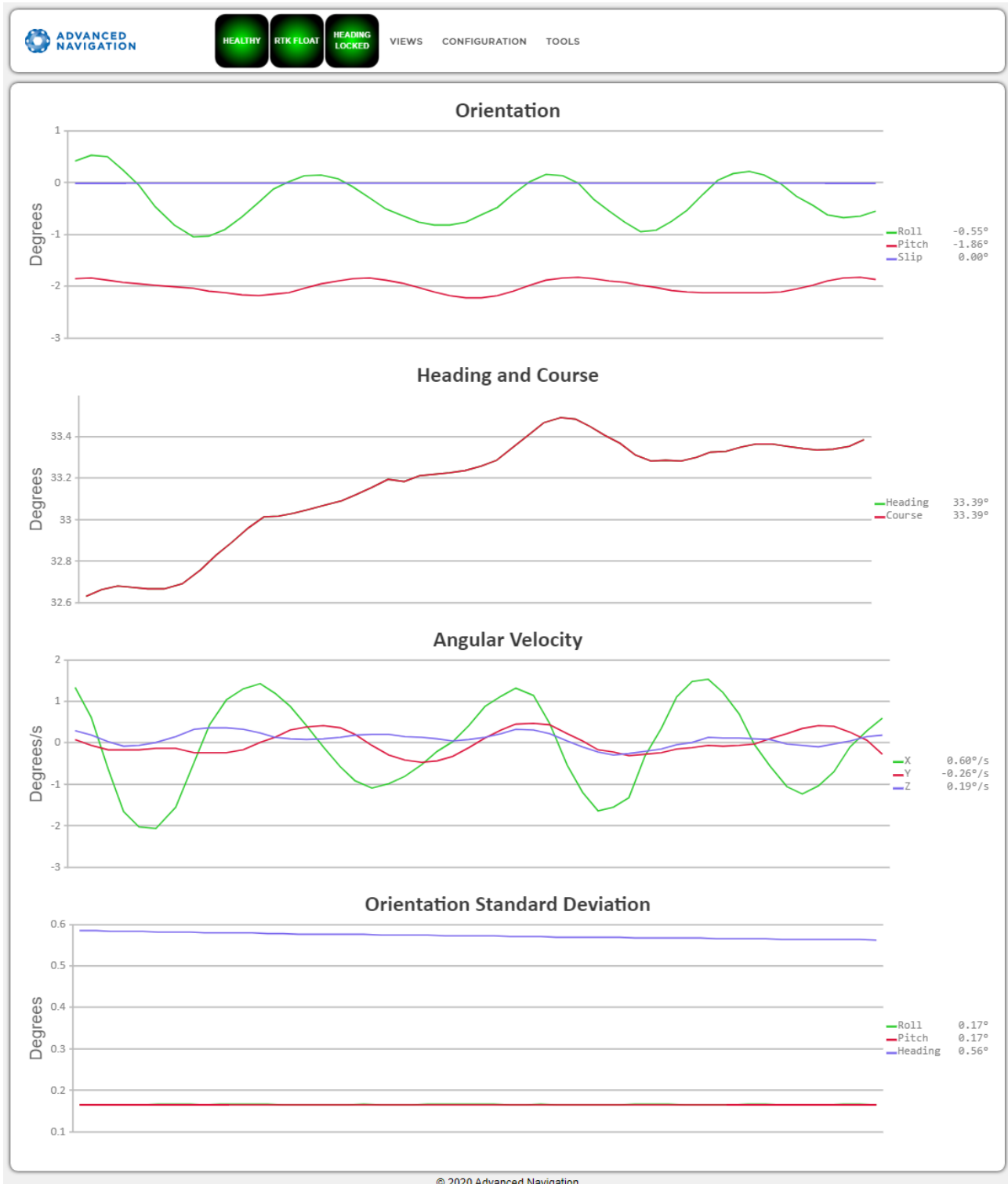

Figure 26: Boreas Web UI Orientation Page

9.1.2.7 Position

The Position page shows the Boreas position and position standard deviation. Latitude and longitude are converted to North and East metres from a reference point that can be reset by refreshing the web page in your browser.



Figure 27: Boreas Web UI Position Page

9.1.2.8 Velocity and Acceleration

The Velocity and Acceleration page shows the Boreas velocity, acceleration and g-force.

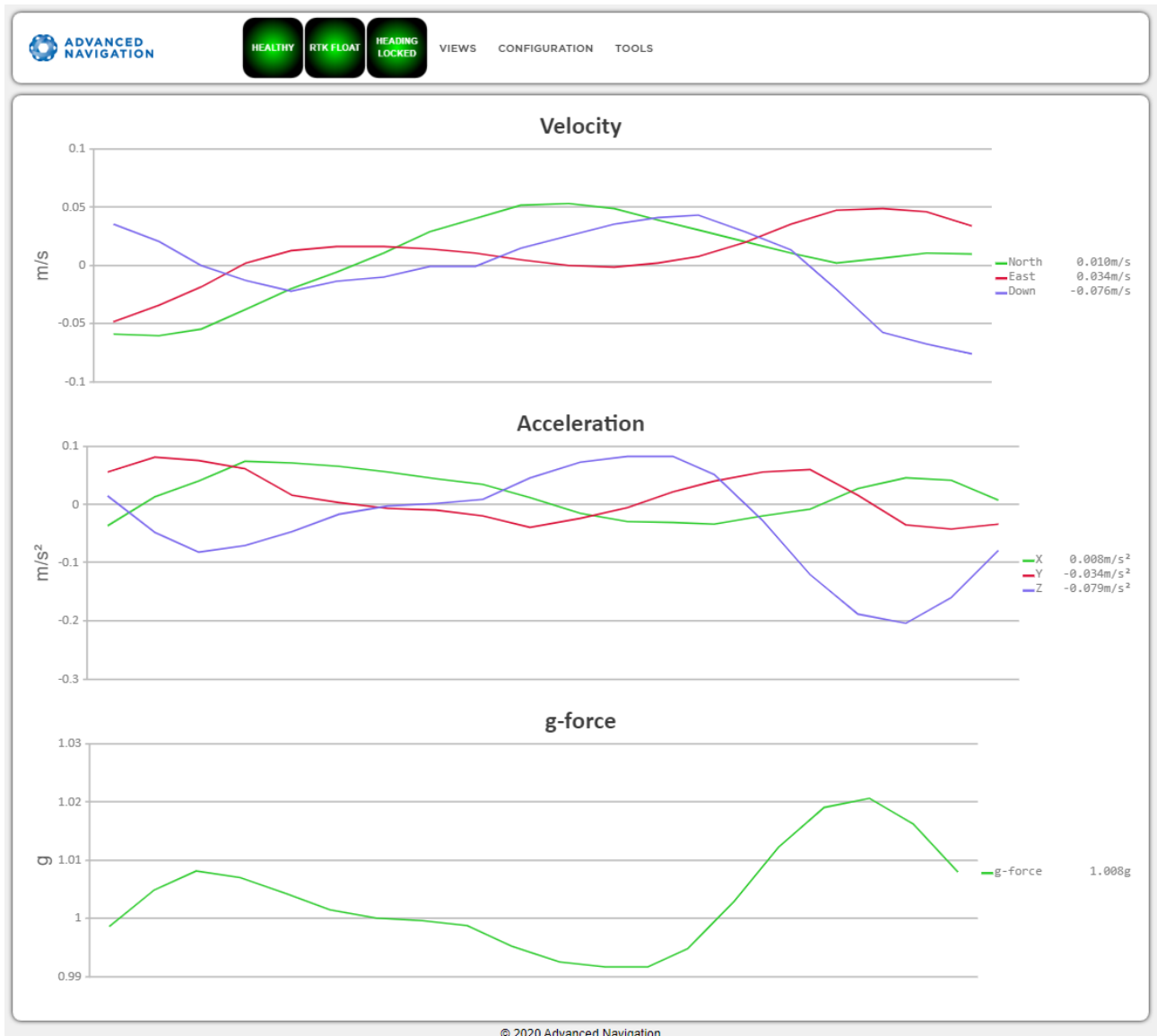

Figure 28: Boreas Web UI Velocity and Acceleration Page

9.1.2.9 Vessel Motion

This page displays the vessel motion (heave, surge, sway) at 4 reference points. Reference point offsets for vessel motion can be configured on the [9.1.3 Configuration Menu](#) page.

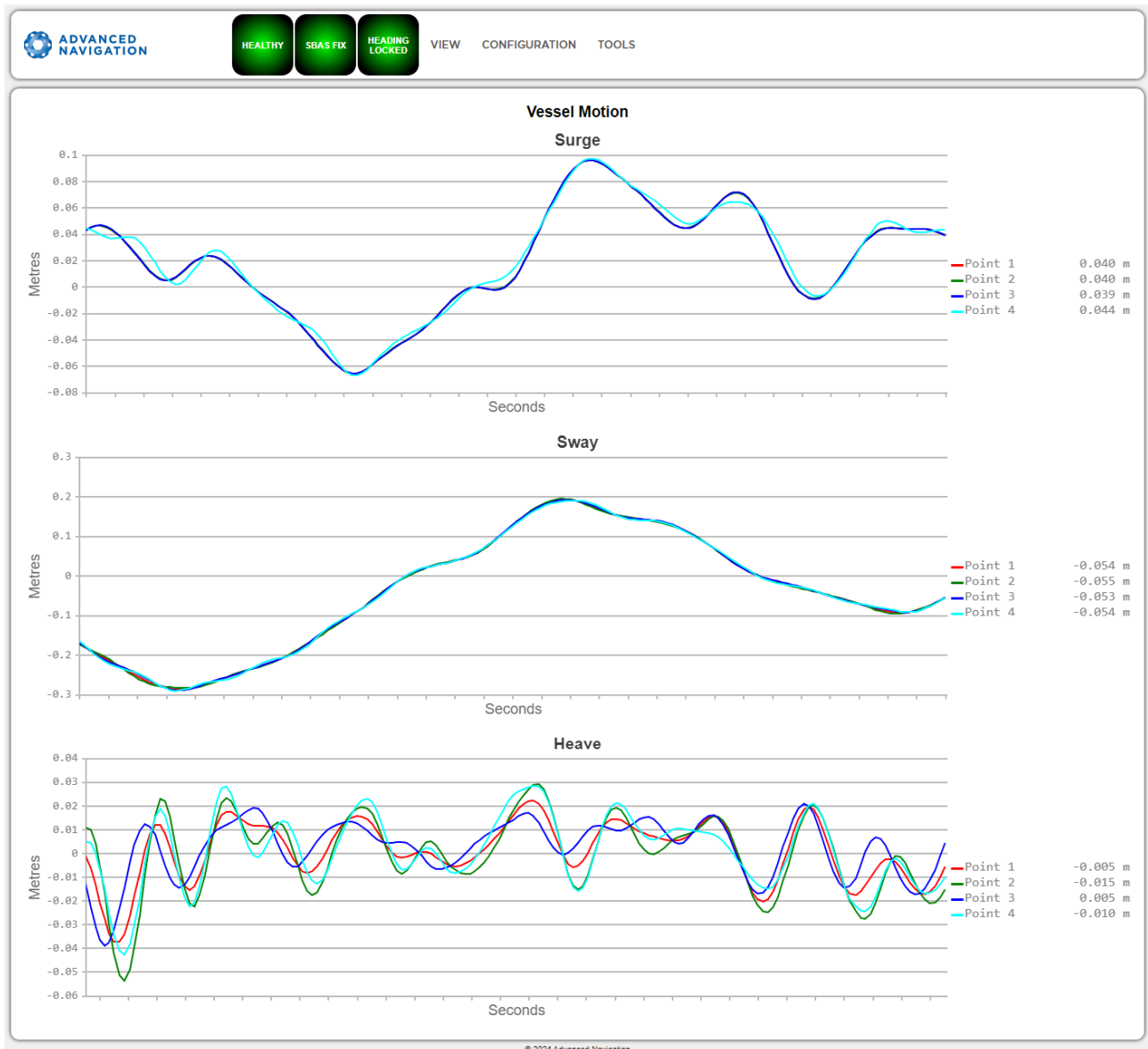

Figure 29: Boreas Web UI Vessel Motion Page

9.1.2.10 Coarse Heading Alignment

Coarse Alignment is used to derive the heading based on a gyrocompass' estimation of true North. For more information, see [8.4 Heading Sources](#). Coarse alignment is necessary to establish an approximate heading when a dual antenna GNSS heading or alternate source is unavailable, such as in a GNSS denied environment. Once coarse alignment is complete, a heading is established, after which the gyrocompass will be used for fine alignment.

The Coarse Heading Alignment page displays the current status of the initialisation process. Given below is a list statuses and warnings that may be displayed during this process:

Status Messages	Description
Awaiting position via GNSS or manual initialisation	An approximate position is required to complete coarse alignment. Initialisation will commence as soon as the position is available. If GNSS positioning is not available, provide the position details manually on the 9.1.3.8 Manual Initialisation page.
Initialising, please wait	With the position known, the process of determining the coarse heading alignment has commenced. This process will take 2 minutes, unless it is restarted due to excessive motion or a significant change in latitude.
Alignment initialised via alternate source	Coarse alignment is not required as heading has been initialised via an alternate source, such as dual antenna , velocity or external input . If heading is available from one of these sources, coarse alignment is not required.
Heading coarse alignment complete	The system has successfully determined an approximate heading.

Table 23: Coarse Heading Alignment - Status Messages

Warning Messages	Description
Initialisation restarted - excessive motion detected	Initialisation has been automatically restarted due to excessive motion.
Initialisation restarted - change in latitude detected	Initialisation has been automatically restarted due to a significant change in latitude.
Initialisation restarted - Change in COG lever arm detected	Initialisation has been automatically restarted due to a change in the Centre of Gravity (COG) lever arm configuration .
Warning - Check latitude, value out of range	A discrepancy between the current latitude and the coarse alignment algorithm has been detected. Check the current latitude is correct.

Table 24: Coarse Heading Alignment - Warning Messages

9.1.3 Configuration Menu

These menus contain the set of configuration settings for Boreas.

9.1.3.1 Filter Options

Ensure that the Vehicle Type filter option is selected for all applications. For most standard applications, the other filter options can be left as their defaults.

See [8.1 Filter Initialisation](#) for more information on these specific settings. If you require assistance, contact support@advancednavigation.com.

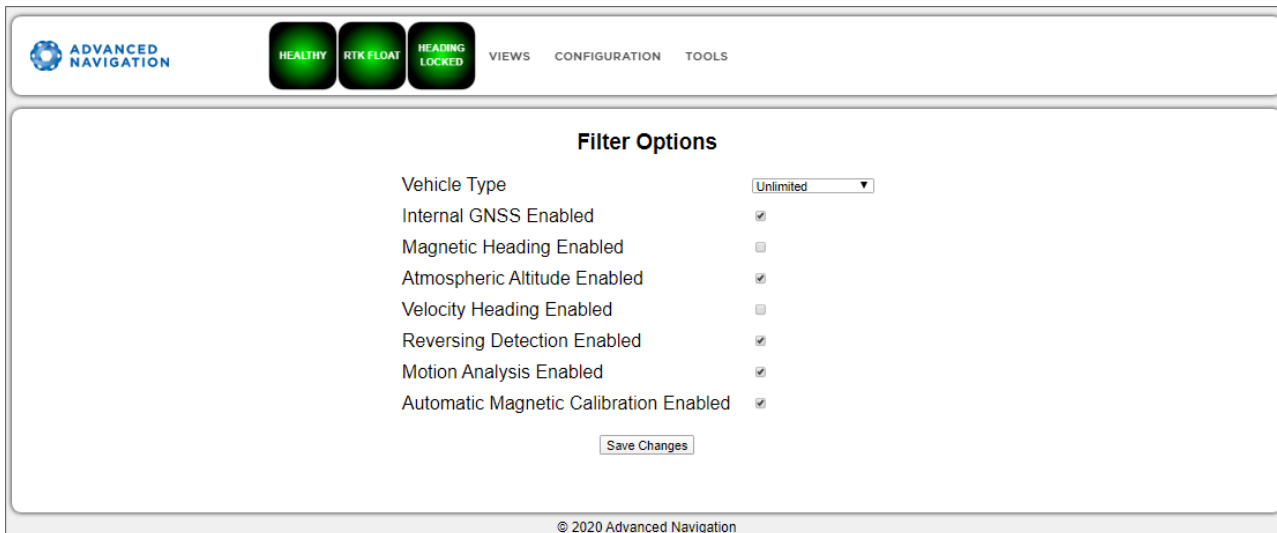

Figure 30: Boreas Web UI Filter Options Page

9.1.3.2 Data Ports

The Data Ports page allows you to specify which data packets or messages are output on a periodic basis and at what rate via a range of serial and Ethernet ports.

Note: The GPIOs and auxiliary port are configured in the Data Ports page only if they are being used as serial transmit and receive lines. To configure GPIOs as digital or frequency inputs or outputs, use the [9.1.3.5 GPIO](#) page.

Other data formats available include NMEA0183, GNSS, TSS1, SIMRAD and other formats. For more information see [10.1.2 Ethernet Functions](#) and [10.2 Serial Interface](#).

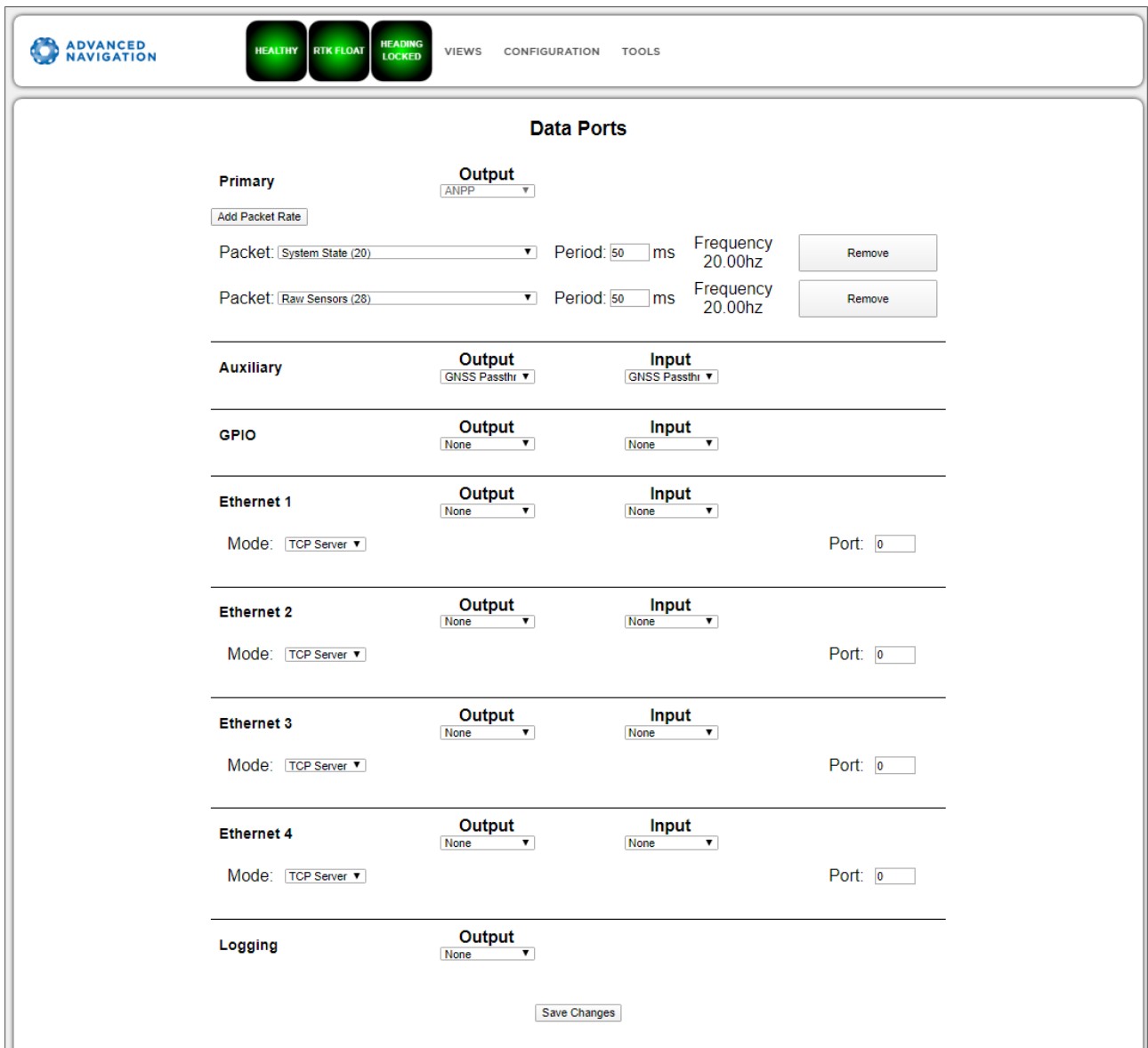

Figure 31: Boreas Web UI Data Ports Page

9.1.3.3 Alignment

The Alignment page is used to set the alignment offsets of the system installation. It is important to set the values on this page correctly to avoid degrading performance.

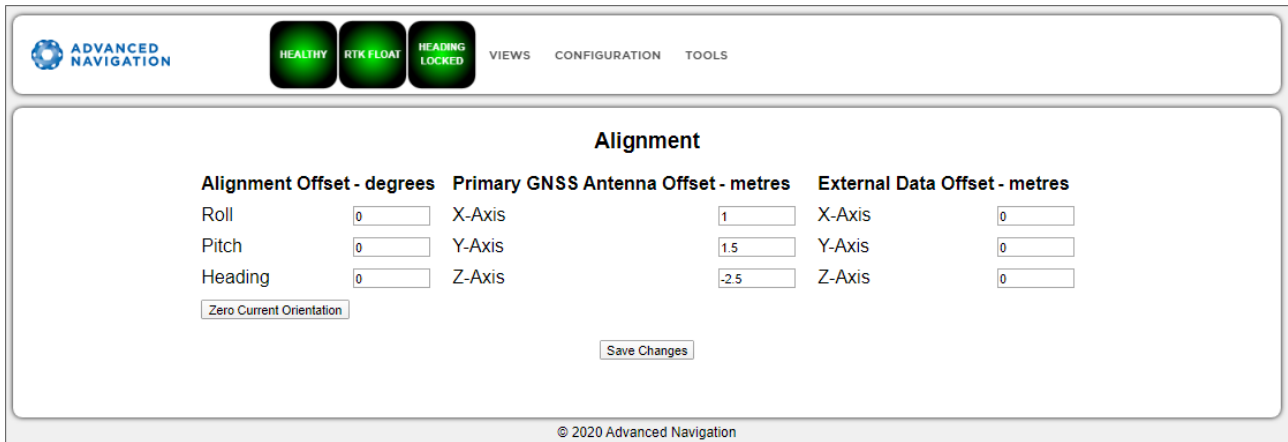

Figure 32: Boreas Web UI Alignment Page

Alignment Offset

If Boreas is installed into the vehicle with the positive X axis pointing forwards and the positive Z axis pointing down, then no alignment offset is required and the roll, pitch and heading offset values can remain at the factory defaults of zero.

If the unit is installed in a different orientation then the roll, pitch and heading offset must be entered. For example, if the unit is installed on its side with the X axis pointing up and the Z axis pointing forwards and no change to the Y axis, then this would result in a pitch offset of +90 degrees with roll and heading remaining zero.

If there is a small misalignment due to mechanical mounting error this can be compensated for by setting the vehicle stationary on a level surface and clicking the **Zero Current Orientation** button.

Note: Zero Current Orientation will only correct for roll and pitch offsets, the Heading offset must be entered manually and saved after using this function.

External Data Offset

These values are only required for speciality applications operating with an external source of velocity and position data. The offsets are used when providing NMEA Input, External GNSS, or with an Air Data Unit. When using a DVL, use the odometer offset. Please contact support@advancednavigation.com for further assistance.

9.1.3.4 Baud Rates

This page is for setting the baud rates for the GPIO, primary and auxiliary ports. The factory default baud rate value for these ports is 115200 bps.

The primary and auxiliary ports can be set to RS232 or RS422. The factory default is RS232 for both ports.

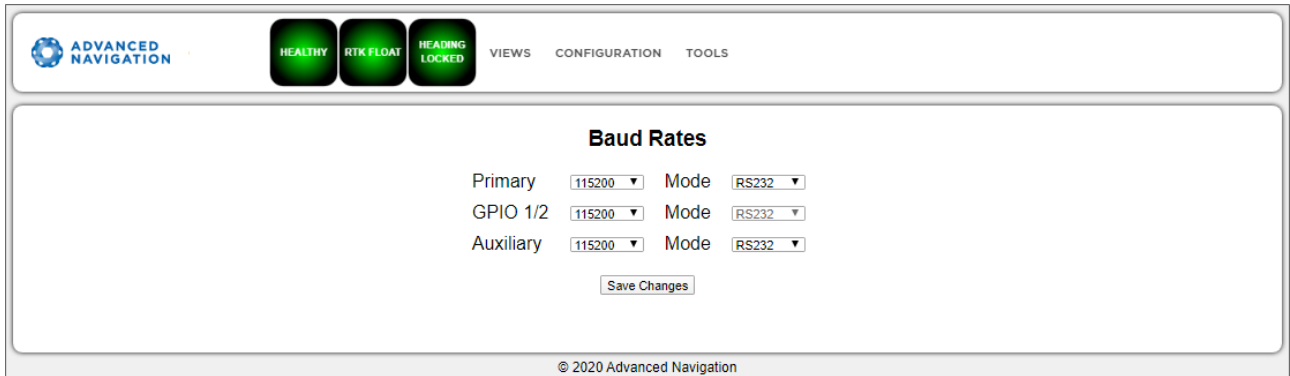

Figure 33: Boreas Web UI Baud Rates Page

9.1.3.5 GPIO

This page allows the user to select the input and output functions of the GPIO and Auxiliary ports. These functions are described in detail in [10.6.1 Dynamic Pin Functions](#). These functions change dynamically and are effective immediately upon clicking **Save Changes**.

Note: The GPIO port functions at RS232 levels for data functions and 0 to 5 volt (or 0 to 3.3 V) levels for all other functions. The auxiliary port functions at RS232 or RS422 levels for data functions and 0 to 5 volt (or 0 to 3.3 V) levels for all other functions. The internal hardware automatically reconfigures based upon the selected function.

The default values for these settings are Inactive. The dedicated 1PPS signal is active by default.

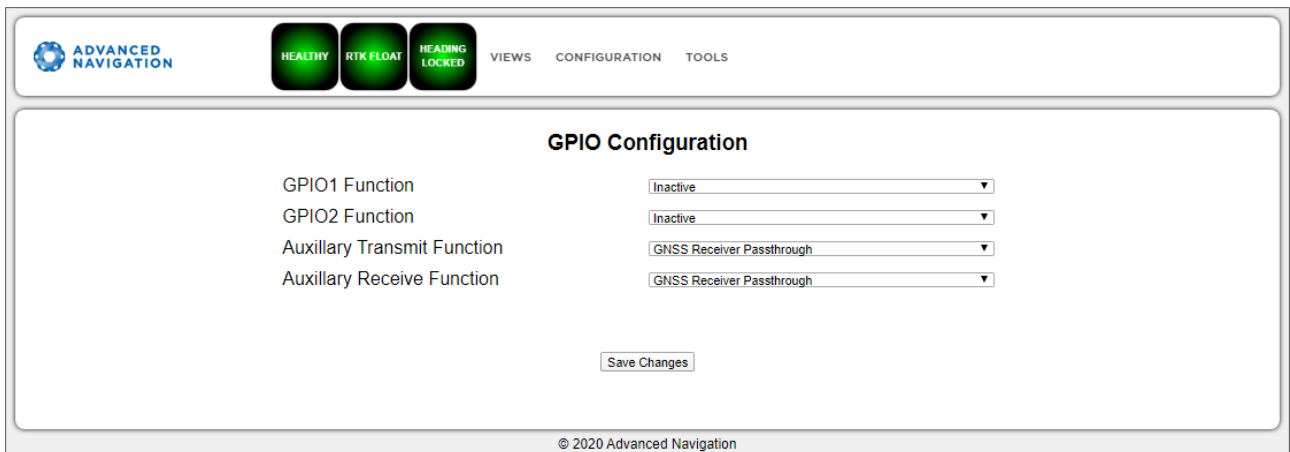

Figure 34: Boreas Web UI GPIO Configuration Page

9.1.3.6 Odometer

The Odometer page allows the user to configure the odometer pulse length and offset. See [7.9 Odometer](#) and [8.8 Odometer Pulse Length](#) for more information on the use of odometers. The odometer offset is also applied when using a DVL input.

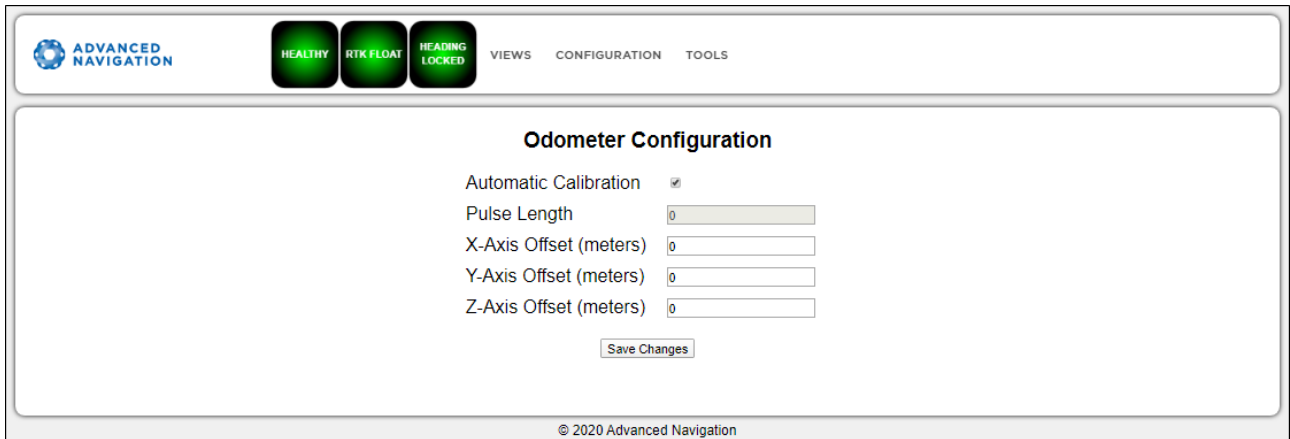

Figure 35: Boreas Web UI Odometer Configuration Page

9.1.3.7 Reset

The Reset button causes the system to perform a power cycle. No configuration settings or state data are lost.

The Cold Start button clears all filters, and connections are reset and must re-established. No configuration settings are lost.

The Factory Reset button resets all Boreas settings back to their factory defaults, including state data and all configuration settings. It also erases the hot start data so that the system is forced to perform a cold start.

Note: A Factory Reset will re-enable the DHCP Client and lose any static IP address settings.

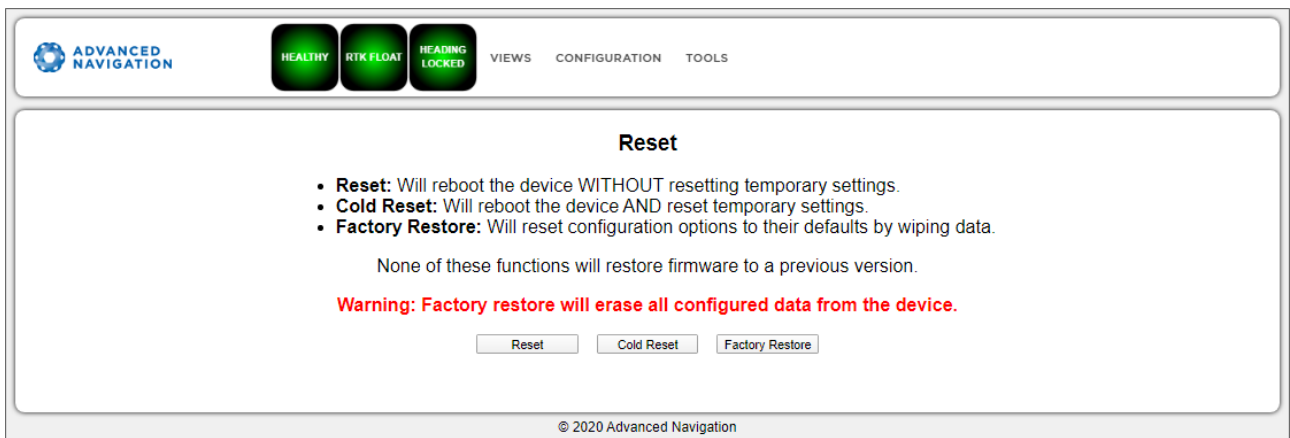

Figure 36: Boreas Web UI Reset Page

9.1.3.8 Manual Initialisation

This page can be used to manually initialise Boreas when a GNSS fix is not available. Setting the position will initialise the navigation filter. Setting the heading will also initialise the heading filter.

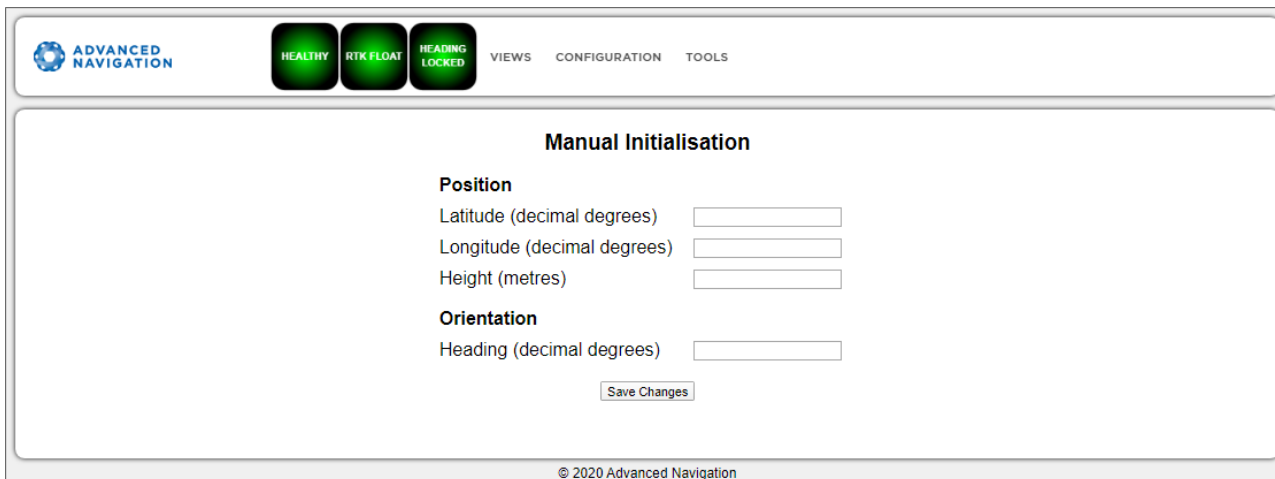

Figure 37: Boreas Web UI Manual Initialisation Page

9.1.3.9 Ethernet Settings

The Ethernet Settings page allows you to enable or disable the DHCP Client. When the DHCP Client is disabled you need to enter the TCP/IP settings if you wish to access the web UI.

If you are only connecting to Boreas via the primary port these settings can be ignored.

The default is for the Ethernet mode to be set to DHCP.

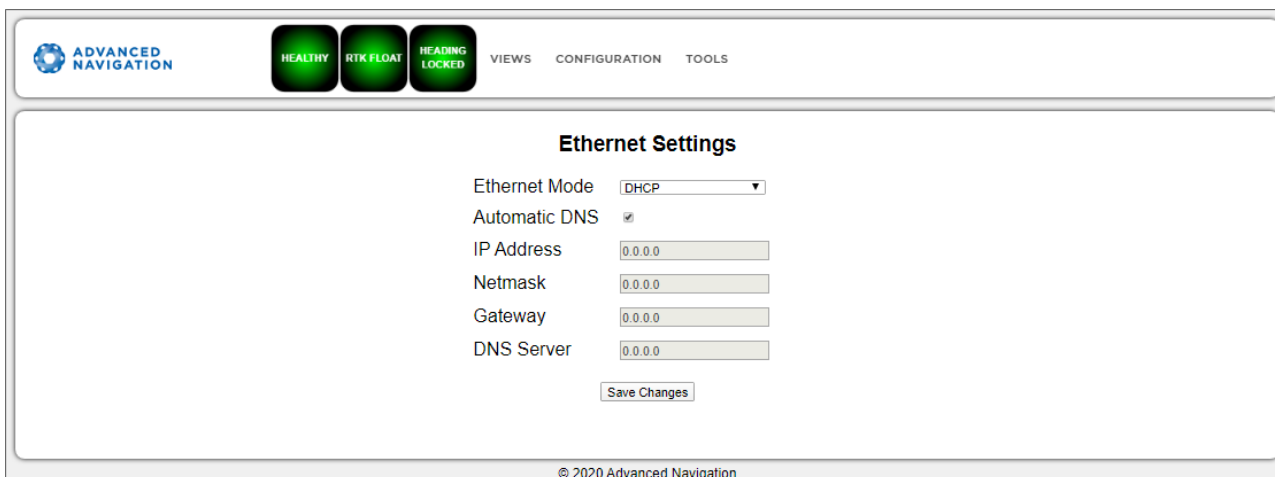

Figure 38: Boreas Web UI Ethernet Settings page

9.1.3.10 NTRIP Client

The NTRIP client built into Boreas can be used to connect to a network DGPS (Differential GPS, a older standard for GNSS corrections of lower performance than RTK) or RTK service to stream correction data to Boreas for DGPS or RTK. The NTRIP client requires that Boreas has an available internet connection to the NTRIP Caster to function.

The source of the corrections data can be either your own base station, configured as an NTRIP Caster, or a third-party service. Either way, you will need the login details for connecting to and authenticating with the NTRIP Caster, and identifying the nearest mountpoint.

These steps are required:

1. Select Enabled.
2. For Host/Server, enter the NTRIP Caster address.

3. For Port, enter the NTRIP Caster port numbe. This is usually 2101.
4. Click Save.
5. Click Get Mountpoints.
6. Select your mountpoint from the Mountpoint drop down list, being mindful that the distance should not exceed 50km.
7. Enter your username in the Username box.
8. Enter your password in the Password box.
9. Click Save.

To disconnect from the NTRIP Caster unselect Enabled and click Save.

Troubleshooting NTRIP Caster Connections

If you cannot get the list of mountpoints, ensure the Host Address and Port number are correct for your NTRIP Caster.

If the Connection Status is not green, and says UNAUTHORISED this indicates an incorrect username or password.

Contact support@advancednavigation.com for further assistance with network DGPS or RTK.

The screenshot displays the 'NTRIP Client' configuration page in the Boreas web interface. At the top, there is a navigation bar with the 'ADVANCED NAVIGATION' logo on the left and three green status indicators: 'HEALTHY', 'RTK FLOAT', and 'HEADING LOCKED'. To the right of these indicators are the menu items 'VIEW', 'CONFIGURATION', and 'TOOLS'. The main content area is titled 'NTRIP Client' and is divided into two sections: 'Status' and 'Configuration'. In the 'Status' section, the 'Connection Status' is shown as 'Connected' with a green dot, and 'Bytes Received' is '96198789 bytes'. The 'Configuration' section includes a list of settings: 'Enabled' (checked), 'Report Position' (unchecked), 'Host' (empty text box), 'Port' (text box containing '2101'), 'Mountpoint' (dropdown menu), 'Username' (text box), and 'Password' (password text box with a visibility toggle). A 'Get Mountpoints' button is located below the 'Port' field, and a 'Save Changes' button is at the bottom of the configuration section.

Figure 39: Boreas Web UI NTRIP Client Page

9.1.3.11 CAN Settings

The CAN Settings page allows you to enable or disable the CAN functionality. If you are only connecting to Boreas via the primary port then these settings can be ignored.

The default for CAN is Enabled at 1,000,000 baud rate. A CANOpen EDS file is bundled with the firmware download.

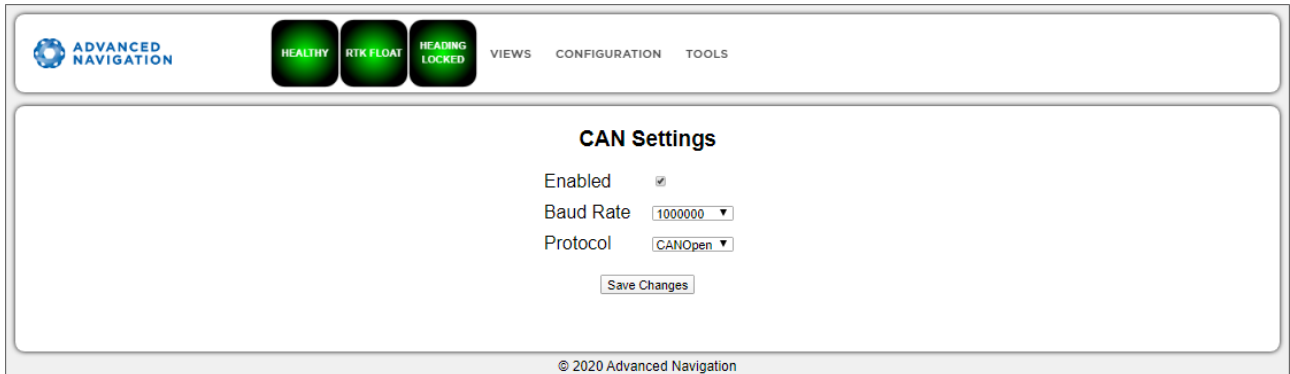

Figure 40: Boreas Web UI CAN Settings Page

9.1.3.12 Advanced

The Advanced page allows you to set the voltage level of the GPIO and 1PPS signals lines along with the packet rates.

The options are 5 V, 3.3 V, or Disabled. The default is 5 V.

Note: The dedicated 1PPS signal is active whenever the voltage is set to 5 V or 3.3 V, and is therefore active by default.

The CANopen output packet rates can be configured as the period between packets in milliseconds within the range of 10 ms to 10,000 ms. The default is 50 ms.

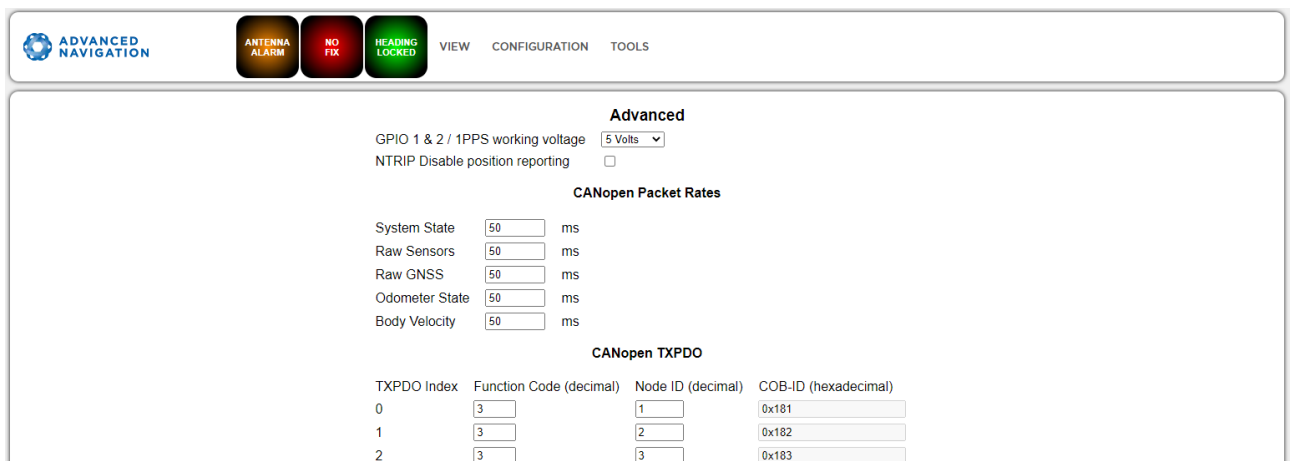

Figure 41: Boreas Web UI Advanced Page

9.1.4 Tools Menu

The Tools menu contains tools for performing certain procedures with Boreas.

9.1.4.1 Firmware Update

This page is used to update the Boreas device firmware, Boreas contains firmware which is regularly updated to improve performance and add features. Advanced Navigation recommends that you upgrade to the latest version whenever available. The firmware update function is robust, such that power loss, file corruption or other issues cannot cause problems with units. Check the [Boreas](#) product page of the Advanced Navigation website periodically for updates.

Note: Advanced Navigation device firmware files have the extension .anfw.

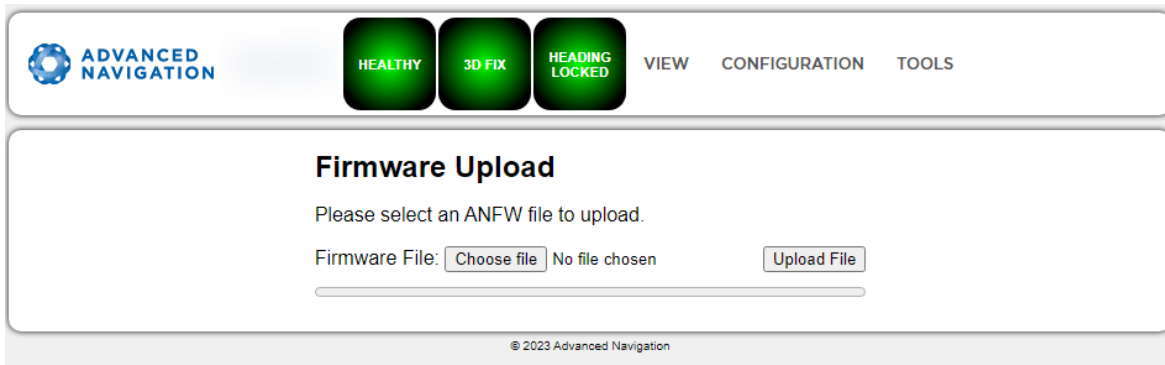

Figure 42: Web UI Firmware Update Page

Click "Choose File" and select the appropriate ANFW file for upload.

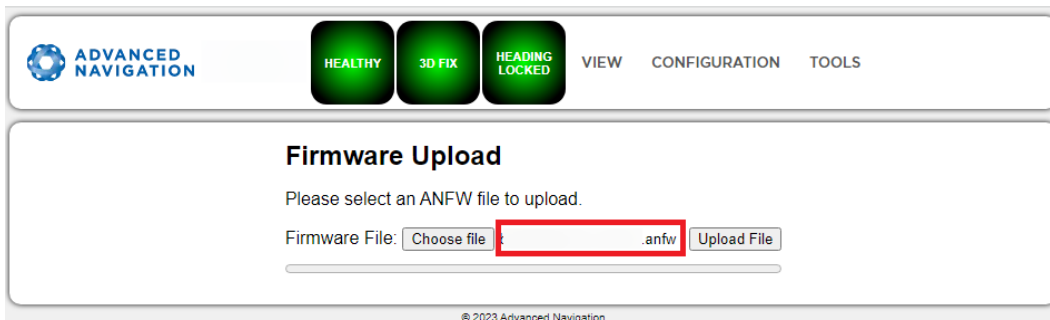

Figure 43: Firmware Update Choose File

Wait while the system uploads the firmware.

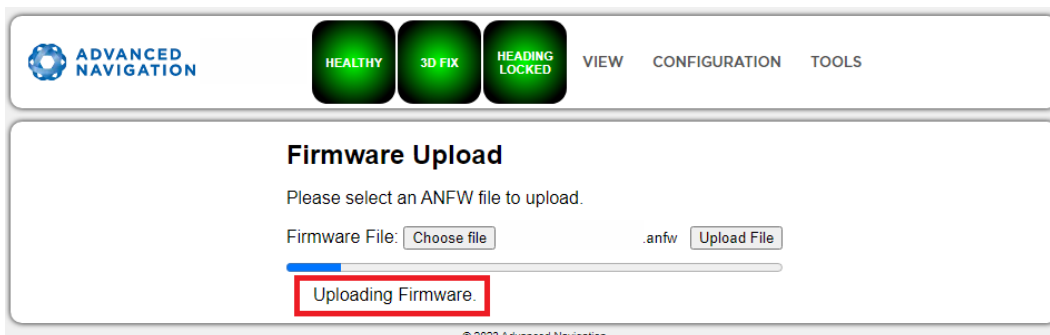

Figure 44: Firmware Update Uploading Firmware

Once uploaded, the system will automatically verify the firmware prior to reboot.



Figure 45: Firmware Update Verifying

Upon successful verification, a dialog box will appear indicating the device is rebooting to apply the update.

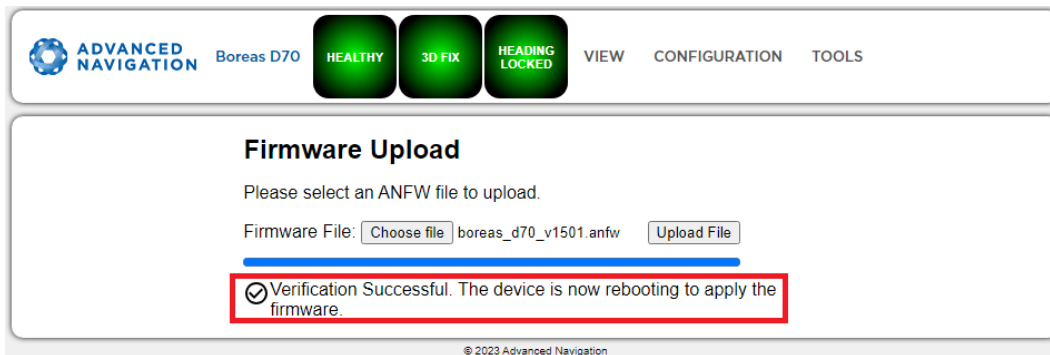

Figure 46: Firmware Update Complete

9.1.4.2 Logs

Boreas features an onboard high capacity data logging system. Logging is enabled by default, but by default no specific data is configured to be logged. To enable logging of specific data packets or messages, see the Logging section on the [9.1.3.2 Data Ports](#) page (in the [9.1.3 Configuration Menu](#)).

If any log files exist on the Boreas they will appear on this page in a list, with the most recent at the top. The log file name includes the date and time the log file recording commenced, using UTC time, in the format BoreasLog_YY-MM-DD_HH-MM-SS.XXX. The log file extension identifies the file type.

If the time and date in the log file name is incorrect, this usually indicates that Boreas does not have a GNSS fix and has therefore not yet determined the correct time.

Note that the logging configuration and recorded log files can only be accessed by the web UI. You cannot use the serial port interfaces.

Note: If there is a requirement not to store potentially sensitive information, it is possible to order Boreas without internal storage. If this is the case, no internal logging will be possible.

Enabling and Disabling Logging

To enable or disable the logging functionality, select or deselect the Enable Logging check box and click Save Changes.

The log file currently being recorded is highlighted in green.

If recording an ANPP-format log file, the log file will include the current Boreas device configuration.

Limiting the Maximum Log File Size

If you wish to limit the maximum file size for individual log files, select the Enable Splitting check box, enter a Max Log Size (in MiB), and then click the Save Changes button. This will not affect pre-existing log files but will affect the currently recording log file. Note this will round down to an integer if you enter a number with decimal places.

Downloading Log Files

You can download individual log files by simply clicking on them. Note, only one log file can be downloaded at a time using this method.

To download multiple log files, first select the files required, and then click the Download Selected button. This will download all the files to your computer and compress them into one ZIP file. Note, it may appear that nothing is happening during this process, and it can take some time to complete.

You can select all log files using the Select All button, or individually select log files using the check box on the left of the log file name.

Deleting Log Files

You can delete log files by selecting the specific log file(s) using the check box to the left of the log file name, or using the Select All button, and then click the Delete Selected button.

For bulk erasing ALL log files you can use the Format button. This will erase all log files irrecoverably. Note, it can take some time.

Starting New Log Files

The Start New Log button will stop writing the current log file and commence writing a new file. This new file will also include the current Boreas device configuration. If logging is currently not enabled, this button will not do anything.

9.1.4.3 Viewing Logged Data

The ANPP log files are binary data and are therefore not in a human-readable format. To convert the ANPP log files you can use the Log Converter function of Boreas Manager, see section [9.2.8.2 Log Converter](#). This will create CSV and KML files for your analysis.

All the ANPP packets are described in detail in [11 Advanced Navigation Packet Protocol](#).

NMEA0183 log files are ASCII text and can be opened in any text editor.

9.2 Using Boreas Manager

Boreas Manager is a software tool provided by Advanced Navigation for logging, testing, display and configuration of Boreas. It is designed to be simple and easy to use. It should run on most Windows, MacOS and Linux computers.

Note: Java 11 is required to run Boreas Manager. Adoptium JRE 11 is the recommended Java installer to be used on all platforms. Install the latest version of Java 11 from [Adoptium](https://adoptium.net/), selecting the correct operating system and architecture for your computer.

Boreas Manager contains almost identical functionality to the web UI. This section will only include the areas that are different or absent from the web UI. Refer to the documentation for [9.1 Using the Web User Interface](#) as required.

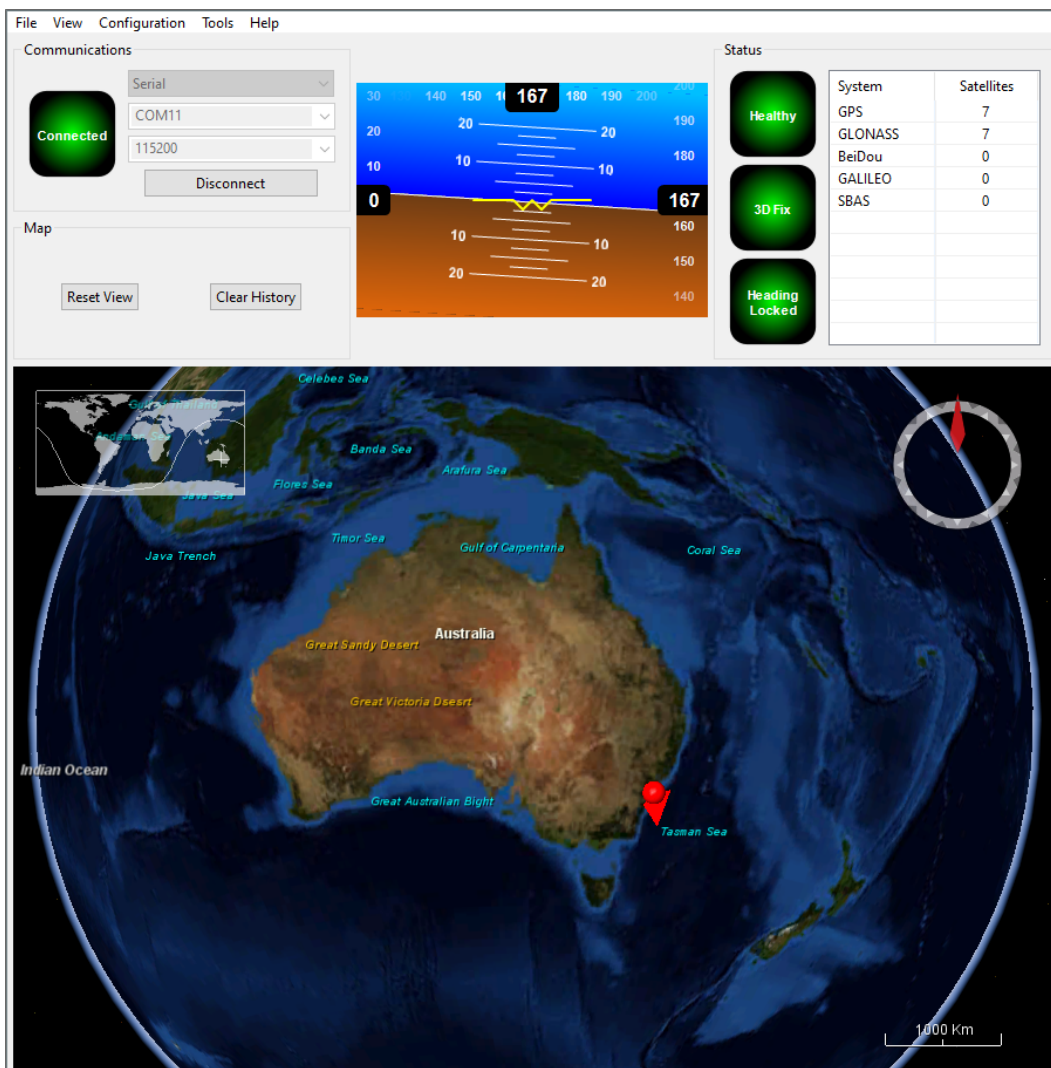

Figure 47: Screenshot of Boreas Manager

9.2.1 Boreas Manager Software Changelog

Version	Date	Changes
7.3	11 April 2024	<p>Added support for Boreas A variants</p> <p>Added vessel motion packet, updated and expanded Heave window to Vessel Motion, including surge and sway</p> <p>Added Train profile as Filter Option vehicle type</p> <p>Improved Trimble license options decoding</p> <p>Added support for NavIC configuration on Trimble receivers</p> <p>Improved usage and syntax information in the command line help</p> <p>Added support for more GPIO functions during log conversion</p> <p>Added command line argument to connect to the device on launch</p> <p>Added argument to open the Manager window maximised</p> <p>Updated device information window to show "BOOTLOADER" when applicable to software version</p>
7.2	10 Nov 2023	<p>Clear map history on reconnection</p> <p>Fix incorrect timezone text displayed in terminal.csv</p> <p>Updated leap-seconds list URL</p> <p>Add automatically log configuration at the start of a new log</p> <p>Added support for NavIC satellite system</p> <p>Fixed indicators behaviour on disconnect</p> <p>Updated support for Mac silicon with latest macOS</p> <p>Added support for extra NMEA 0183 messages</p> <p>Removed GNSS status indicator</p> <p>Fixed issue with opening windows containing charts</p> <p>Update support for Trimble BD9xx RTX frequencies as of 30 Sep 2022</p> <p>Show COCOM status of Trimble BD9xx receivers in the licence field</p> <p>In satellites window, only populate azimuth and elevation fields in the table view when the values have been determined</p> <p>Added elevation to the gimbal state packet</p> <p>Add support for Boreas subtypes</p> <p>Add ability to set Packet Timer period</p>
7.0	13 February 2023	<p>Updated from JDK8 to JDK11. JRE11/JDK11 required to run this release</p> <p>Refresh Port Mode information on reconnection</p> <p>Refresh Packet Rates information on reconnection</p> <p>Fixed Ethernet Settings Static IP setting</p> <p>Improved reliability of firmware update</p> <p>Changed Low Voltage label to Internal Data Logging Error to support newer firmware</p> <p>When the NTRIP sourcetable says authentication type is any of ", 'B', 'N', then use Basic Authentication. This is to workaround NTRIP servers that incorrectly populate the authentication field</p> <p>Overwrite/clear existing packet rates on import of configuration</p> <p>Added support for ARM (aarch64) processors with 64-bit OS</p> <p>Added support for Apple M1 processors and improved MacOS support</p> <p>Various UI improvements</p>
6.2	10 October 2022	<p>Fixed Heading indicator reporting as invalid after a successful Coarse Heading Alignment</p>

Version	Date	Changes
6.1	18 February 2022	Initial release of Boreas Manager

Table 25: Boreas Manager Software Changelog

9.2.2 System Requirements

Boreas Manager is only available for systems with x64 and ARM architectures.

Boreas Manager includes a 3D mapping display which requires an internet connection. If your machine does not meet the graphics requirements the mapping view will only show space without a globe.

Note, when Boreas is running at very high output rates e.g. 1000 Hz, Boreas Manager can consume significant system resources handling such large quantity of data.

9.2.3 Installation and Starting

The latest version of Boreas Manager can be downloaded from the [Boreas](#) product page of the Advanced Navigation website. Installation notes are as follows:

- **Java 11 is required** to run Boreas Manager.
Adoptium JRE 11 is the recommended Java installer to be used on all platforms. Install the latest version of Java 11 from [Adoptium](#), selecting the correct operating system and architecture for your computer.
- No installation process required for the Boreas Manager application on a Windows system — it can be run from any directory by simply double clicking on it. To open the program on some systems it may be necessary to right click and select open with → Java Runtime Environment.
- On MacOS systems it may be necessary to run the application from a terminal window:

```
java -jar -XstartOnFirstThread BoreasManager.jar
```
- On Linux systems it may be necessary to run the application from a terminal window:

```
java -jar BoreasManager.jar
```

The Boreas Evaluation Kit includes an FTDI USB to RS232 / RS422 adaptor cable. The drivers are normally installed automatically, but if not they are available for download from www.ftdichip.com/Drivers/VCP.htm.

9.2.4 Troubleshooting

If the application will not start, the most common reason is that you have 32-bit Java installed on a 64-bit operating system. Uninstall Java and reinstall the 64-bit version.

If the globe does not appear in the 3D map area, this indicates that either your graphics card is not powerful enough, your graphics card driver is out of date, or you have no internet connection.

- Ensure the RS232 / RS422 switch is in the correct mode. The Boreas factory default mode is RS422.
- Ensure you select the correct COM port. This can be easily identified by unplugging and re-plugging in the USB connector.
- Ensure you have the correct baud rate selected in Boreas Manager. The factory default value for the baud rate is 115200 bps for the Primary, GPIO and Auxiliary ports.

Contact technical support support@advancednavigation.com if you have any questions or require further assistance.

9.2.4.1 Windows

There is a well known problem with USB serial devices under Windows known as “crazy mouse”. The problem occurs when the system mistakenly installs the USB serial device as a mouse. If you experience this problem,

often a restart will resolve it. Otherwise there is a tool that can fix this issue available at <http://www.stentec.com/anonftp/pub/wingps/pnpblockersetup.exe>.

If the serial port does not show up when you plug in the FTDI USB to RS232/RS422 adaptor cable, you may need to install the drivers from www.ftdichip.com/Drivers/VCP.htm.

When operating Boreas on Windows at a high data rate, data can be lost due to the latency of the FTDI driver. To resolve this problem the latency of the driver should be reduced to 1 ms:

1. Start the Windows Device Manager (1) and find the Ports section (2).
2. Identify the specific COM port being used (3) by dis-connecting and re-connecting the USB to RS232 / RS422 adaptor cable.
3. Right click on the identified COM port and select Properties. Select the Port Settings tab (4) and select Advanced (5).
4. Change the Latency Timer value (6) to 1 msec then press OK (7), and OK again for the previous window.

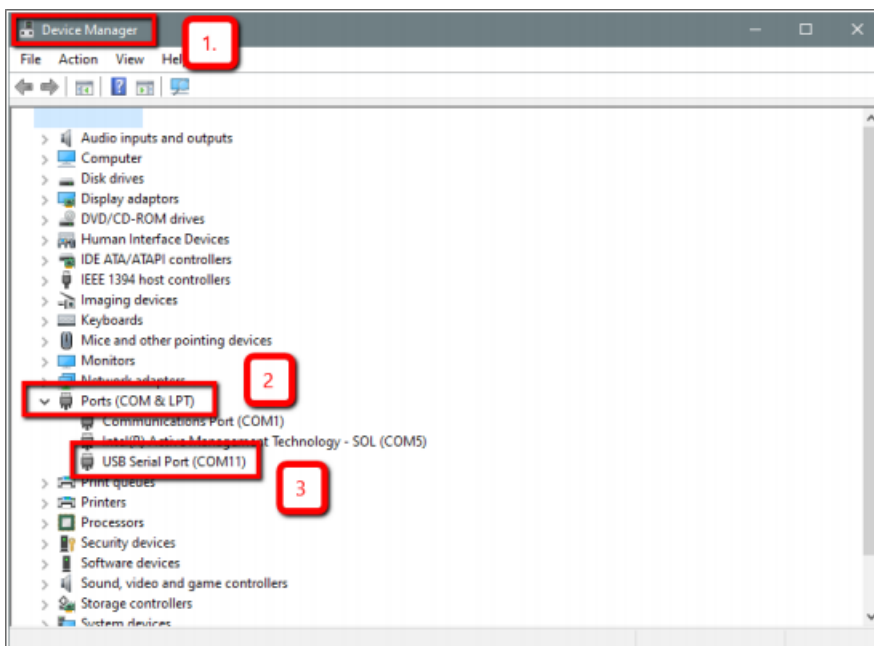

Figure 48: Setting the Windows Port Latency Value - 1

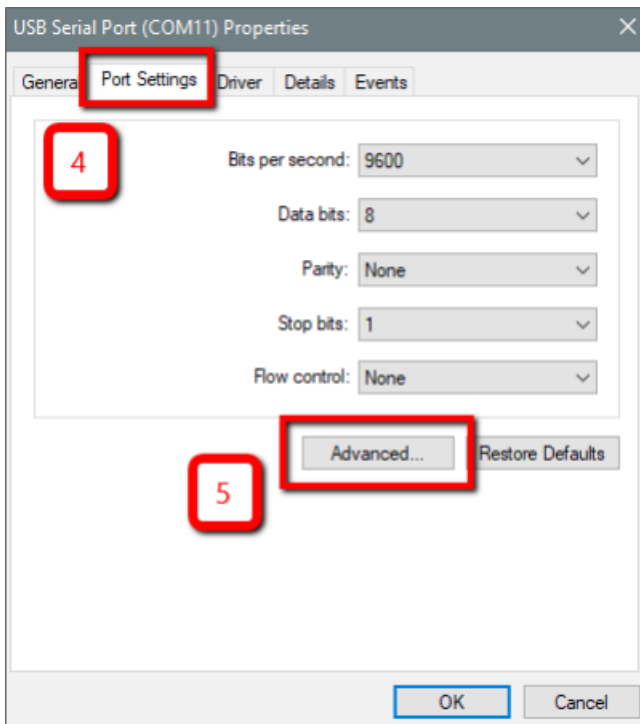

Figure 49: Setting the Windows Port Latency Value - 2

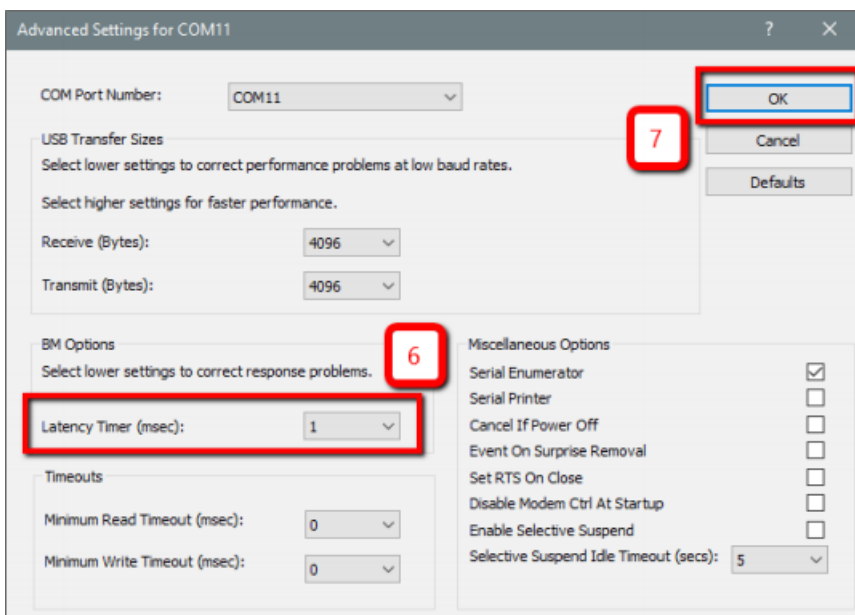

Figure 50: Setting the Windows Port Latency Value - 3

9.2.4.2 Linux

If serial ports do not show up, the typical reason is a lack of permissions. The user should add themselves to the dialout group with the command:

```
sudo adduser username dialout
```

Compiz causes issues with the 3D mapping. If you are experiencing problems it is recommended to turn off Compiz.

Modemmanager can also sometimes cause problems on Linux installations. If you are not using a modem, it is recommended to remove modemmanager with the command:

```
sudo apt-get remove modemmanager
```

9.2.5 Main View

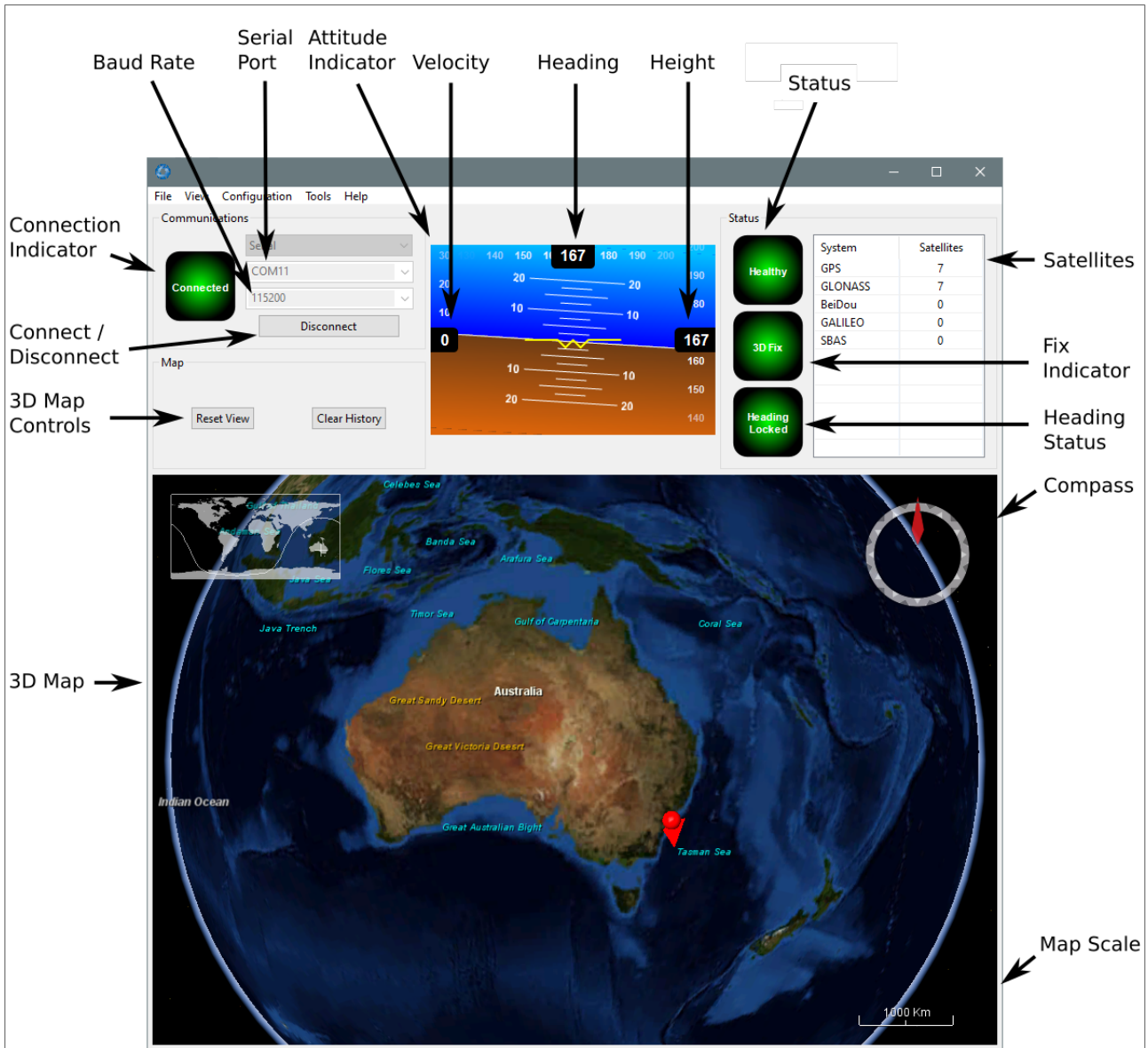

Figure 51: Manager Main View

9.2.5.1 Serial Port

The Serial Port dialogue is used to connect to Boreas. Select the serial port and baud rate and click **Connect**. The default baud rate of Boreas is 115200. The Connection Indicator displays whether there is communication with a Boreas unit.

9.2.5.2 Attitude Indicator

The aircraft style Attitude Indicator shows roll and pitch through a virtual horizon. Around the sides heading, speed and height are shown. All units are SI (metric) and degrees.

9.2.5.3 Satellites Table

The Satellites table shows the number of satellites visible by the primary antenna. More detailed information can be found in the [9.2.6.4 Satellites](#) sub section under the [9.2.6 View Menu](#).

9.2.5.4 Status Indicator

The Status indicator section contains a Boreas status indicator, a fix indicator and a satellites table.

- Boreas Status Indicator - This indicator shows any problems with Boreas. Before a GNSS position fix is achieved it will show the status “Filter not initialised”. Once the filter has initialised it should show “Healthy”. Clicking on the indicator will show the detailed status flags.
- Fix Indicator - This shows the status of the GNSS position fix. Under normal operating conditions it should show either “3D Fix” or “SBAS Fix”. When satellite visibility is poor it may show either “2D Fix” or “No Fix”.
- Satellites Table - The Satellites table shows the number of active satellites being used in the current GNSS solution. More detailed information can be found in the satellites view.

9.2.5.5 3D Map

The 3D map shows the Boreas position on the Earth as well as a red trail of position history. When the filter initialises the map will automatically reset the view to the Boreas position. To move the camera click and drag on the map. To zoom in and out use the mouse scroll wheel. To change the camera view right click and drag or shift click and drag.

9.2.5.6 3D Map Controls

- Reset View : This resets the map view to current position.
- Clear History: This clears the current position history, this is the red trail shown on the map.

9.2.5.7 Baud Rate

This displays the current and available baud rates options for the serial connection.

9.2.5.8 Connect / Disconnect

This button enables the serial connection to be either connected or disconnected.

9.2.6 View Menu

9.2.6.1 View

The View menu contains a number of different options for viewing data from Boreas.

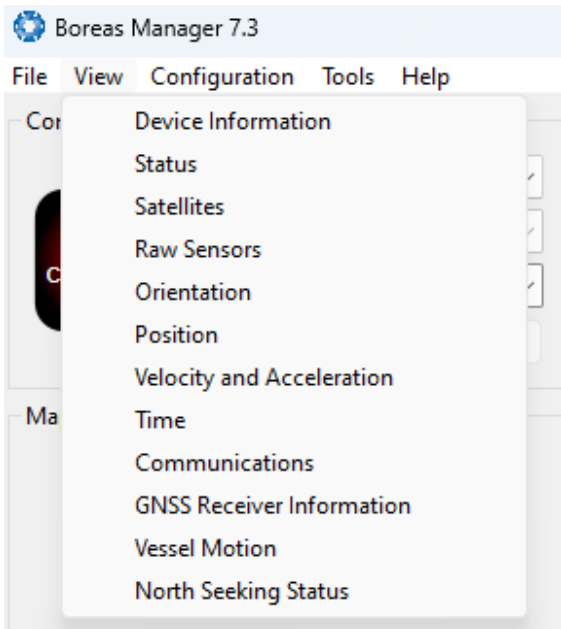

Figure 52: Manager View Menu

9.2.6.2 Device Information

Device information is useful during technical support and for tracking your serial number, firmware and hardware version.

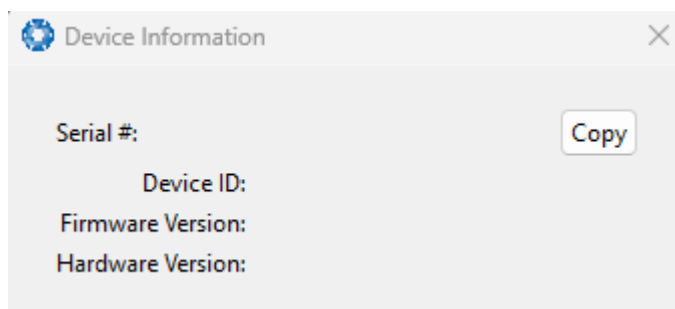

Figure 53: Manager Device Information

9.2.6.3 Status

The Status shows the current status of Boreas as reported by sections [11.4.1 System State Packet](#) (ID#20).

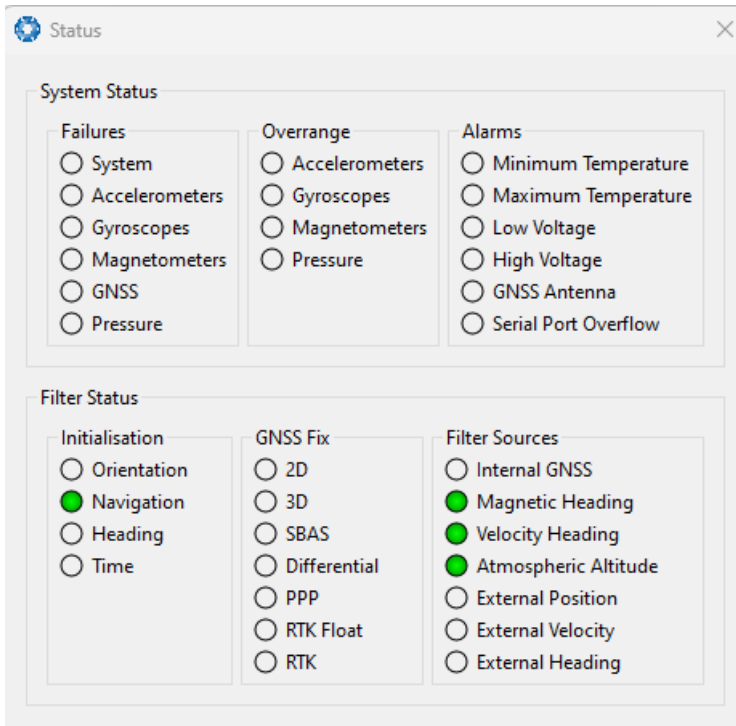

Figure 54: Manager Status Dialogue

9.2.6.4 Satellites

Note: The satellites page will only display satellite data if the Boreas has a license upgrade to full INS capability, and is interfaced to an external GNSS receiver.

The information is displayed as a satellite skyplot, a table and an SNR (Signal-to-Noise Ratio) graph. A maximum of 28 satellites will be displayed, even if more are accessible. This plot shows the SNR of each satellite at the primary and secondary antenna. As a guideline, these should be within 5-10 dB of each other in the absence of cable or antenna faults. Elevation and azimuth are in units of degrees.

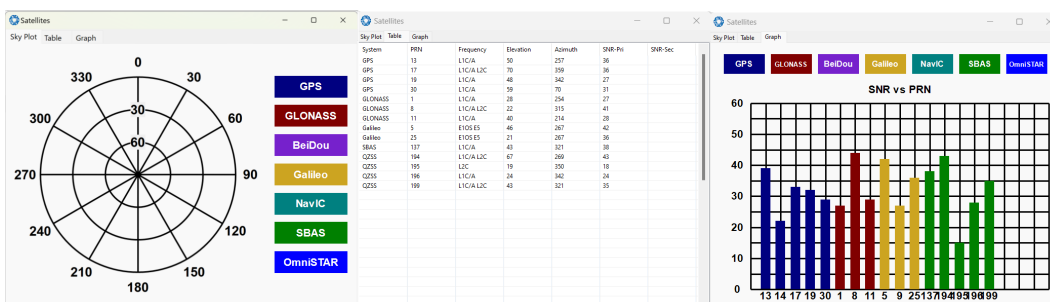

Figure 55: Manager Satellites Table

9.2.6.5 Raw Sensors

Raw sensors shows the temperature calibrated raw sensor values.

Temperature readings are available for a range of sensors: T(Ax), T(Ay), and T(Az) correspond to the accelerometer's x, y, and z axes; T(Gx), T(Gy), and T(Gz) relate to the gyroscope's X, Y, and Z axes; T(M) is for the magnetometer; and T(P) indicates pressure.

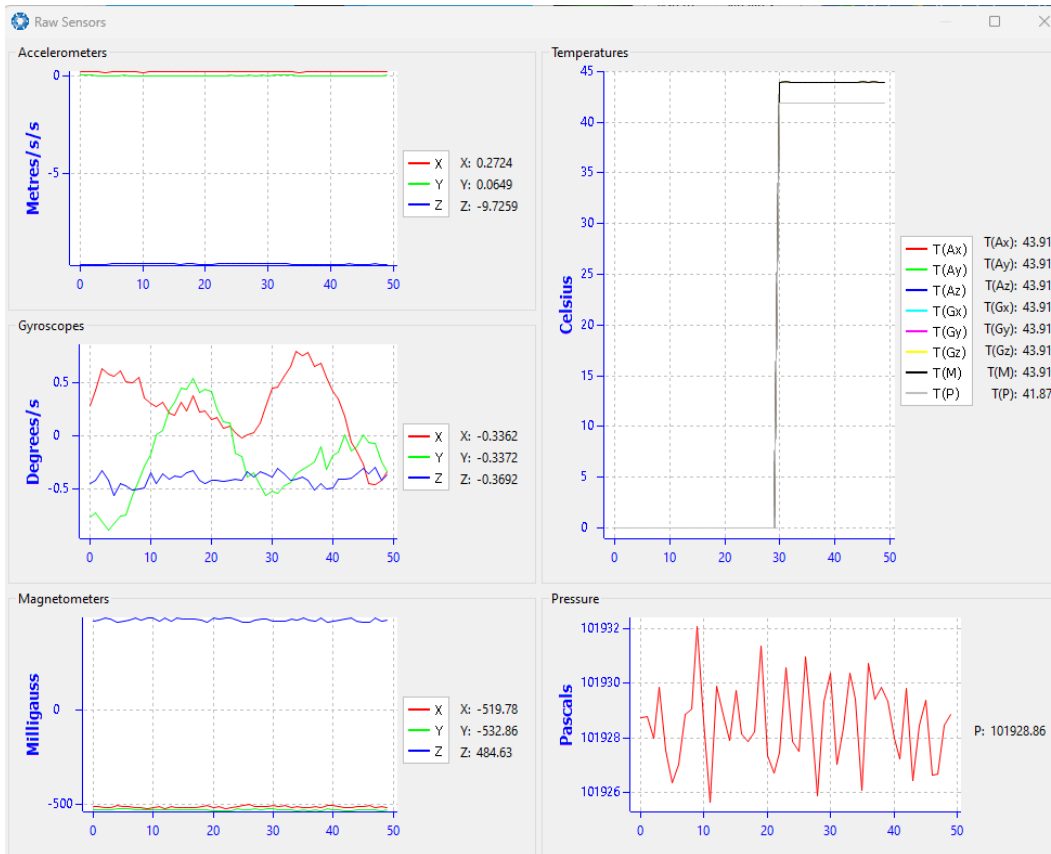

Figure 56: Manager Raw Sensor Outputs

9.2.6.6 Orientation

Orientation shows the Boreas orientation, angular velocity and orientation error. To enhance the user's understanding of some of the less intuitive metrics, **Course** is defined as the path determined by measuring sequential positions, and **Slip** is the difference between the heading and the course.

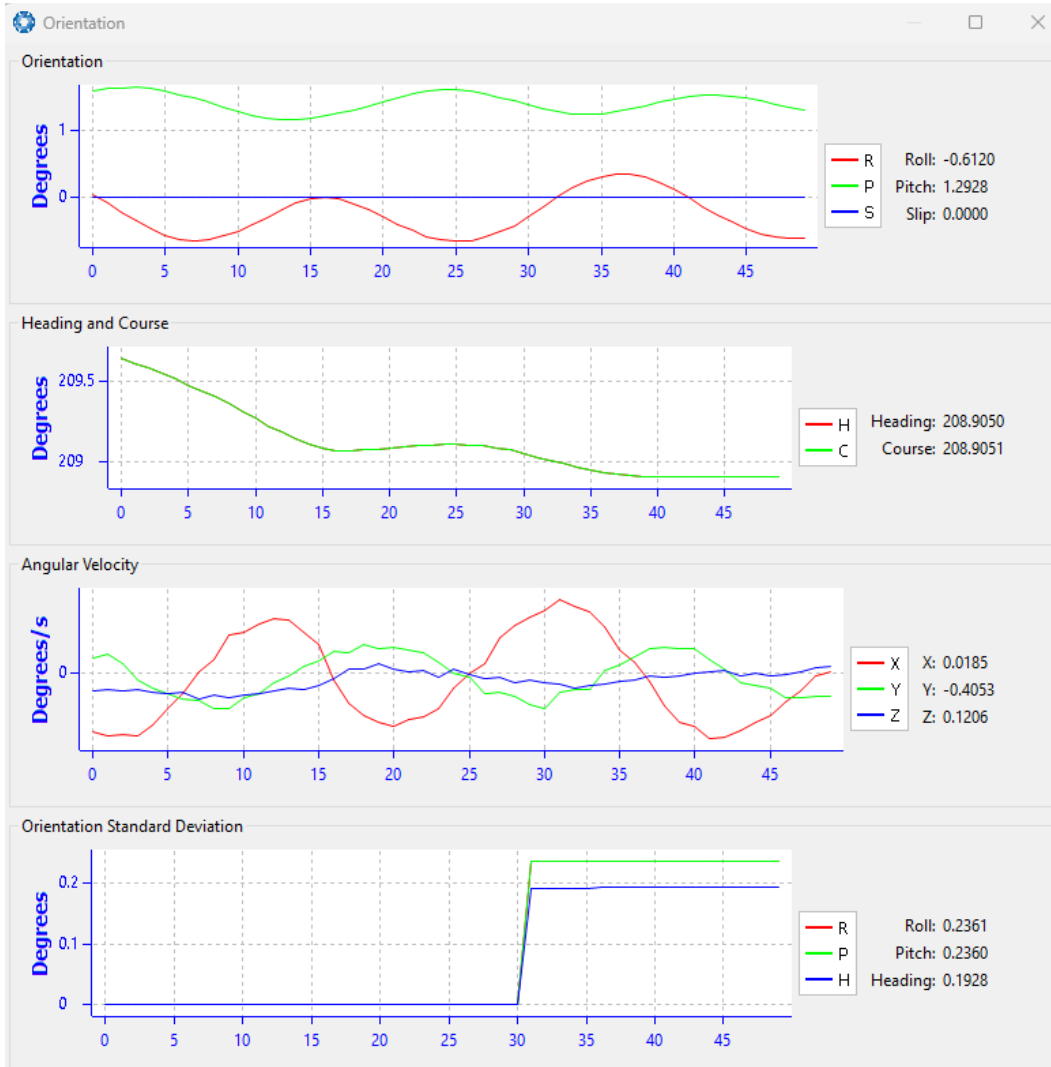

Figure 57: Manager Orientation Outputs

9.2.6.7 Position

Position shows the Boreas position and position error. Latitude and longitude are converted to North and East metres from a reference point that can be reset.

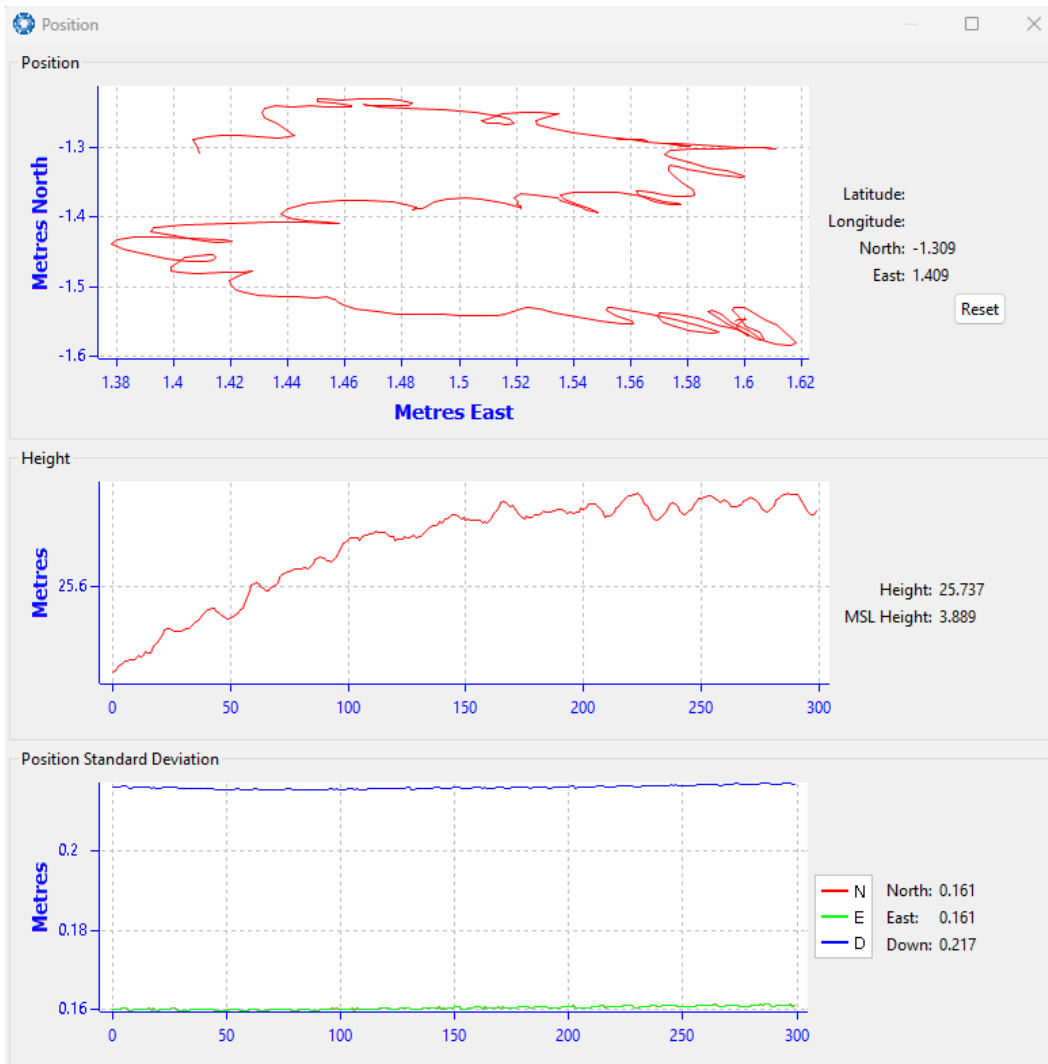

Figure 58: Manager Position Outputs

9.2.6.8 Velocity and Acceleration

Velocity and Acceleration shows the Boreas velocity, acceleration and g-force.

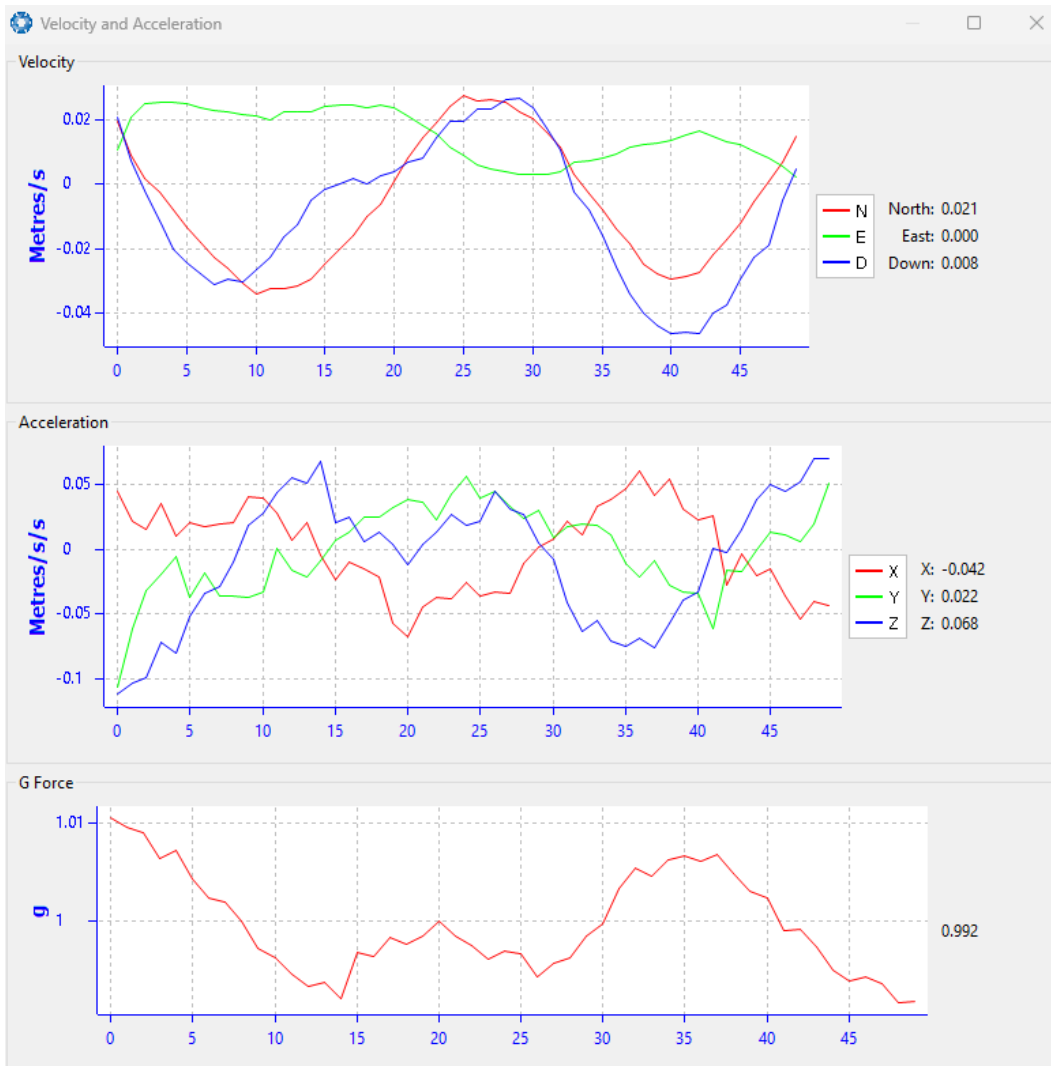

Figure 59: Manager Velocity and Acceleration Outputs

9.2.6.9 Time

This dialogue box allows the to view the time for the connected device. Views are in Unix, UTC, or Local time formats to best suit user requirements to ensure accurate timekeeping and synchronisation across systems.

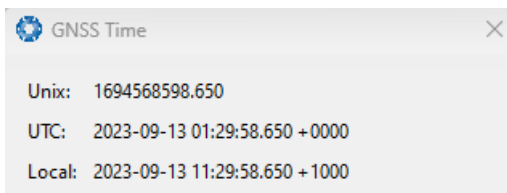

Figure 60: Time Dialogue

9.2.6.10 Communications

This dialogue shows statistics on the data packets received from Boreas and can be useful in diagnosing signal integrity problems.

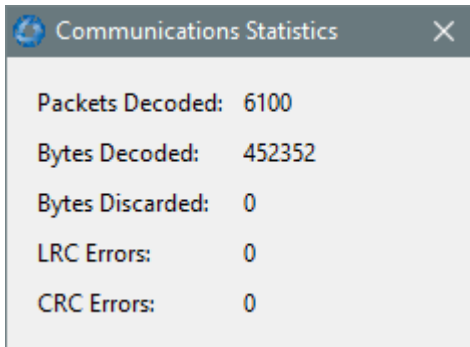

Figure 61: Manager Communications Dialogue

9.2.6.11 Vessel Motion

For the Vessel Motion dialogue to display vessel motion data, the Vessel Motion Packet (ID 89) must be configured in the [9.2.7.3 Packet Rates](#) dialog. Reference point offsets for heave are configured in the [9.2.7.9 Reference Position Offsets](#) dialog.

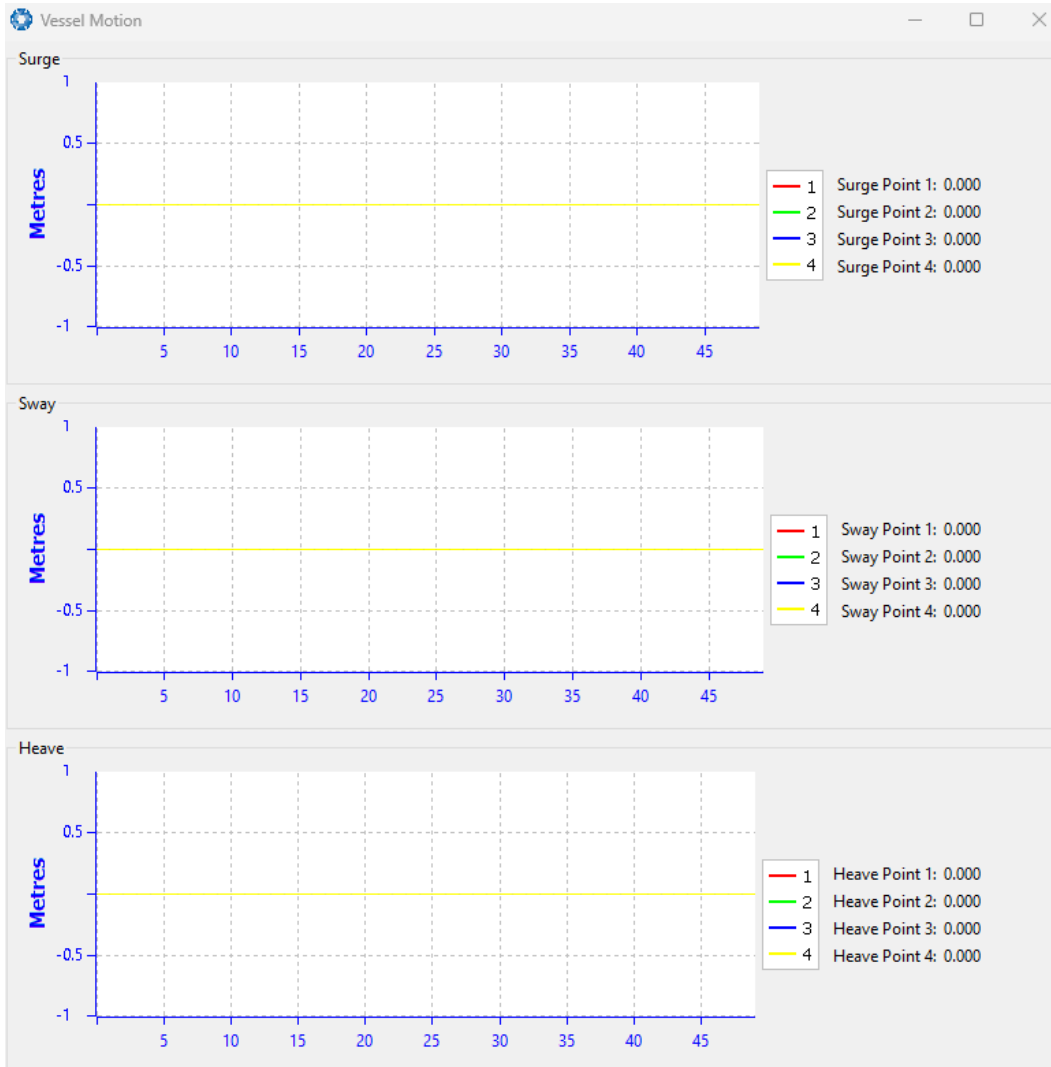

Figure 62: Manager Vessel Motion Outputs

9.2.6.12 North Seeking Status

Coarse Alignment is used to derive the heading based on a gyrocompass' estimation of true North. For more information, see [8.4 Heading Sources](#). Coarse alignment is necessary to establish an approximate heading when a dual antenna GNSS heading or alternate source is unavailable, such as in a GNSS denied environment. Once coarse alignment is complete, a heading is established, after which the gyrocompass will be used for fine alignment.

The Coarse Heading Alignment page displays the current status of the initialisation process. Given below is a list statuses and warnings that may be displayed during this process:

Status Messages	Description
Awaiting position via GNSS or manual initialisation	An approximate position is required to complete coarse alignment. Initialisation will commence as soon as the position is available. If GNSS positioning is not available, provide the position details manually on the 9.1.3.8 Manual Initialisation page.
Initialising, please wait	With the position known, the process of determining the coarse heading alignment has commenced. This process will take 2 minutes, unless it is restarted due to excessive motion or a significant change in latitude.
Alignment initialised via alternate source	Coarse alignment is not required as heading has been initialised via an alternate source, such as dual antenna , velocity or external input . If heading is available from one of these sources, coarse alignment is not required.
Heading coarse alignment complete	The system has successfully determined an approximate heading.

Table 26: Coarse Heading Alignment - Status Messages

Warning Messages	Description
Initialisation restarted - excessive motion detected	Initialisation has been automatically restarted due to excessive motion.
Initialisation restarted - change in latitude detected	Initialisation has been automatically restarted due to a significant change in latitude.
Initialisation restarted - Change in COG lever arm detected	Initialisation has been automatically restarted due to a change in the Centre of Gravity (COG) lever arm configuration .
Warning - Check latitude, value out of range	A discrepancy between the current latitude and the coarse alignment algorithm has been detected. Check the current latitude is correct.

Table 27: Coarse Heading Alignment - Warning Messages

9.2.7 Configuration Menu

The Configuration menu contains a number of dialogues for the configuration of Boreas.

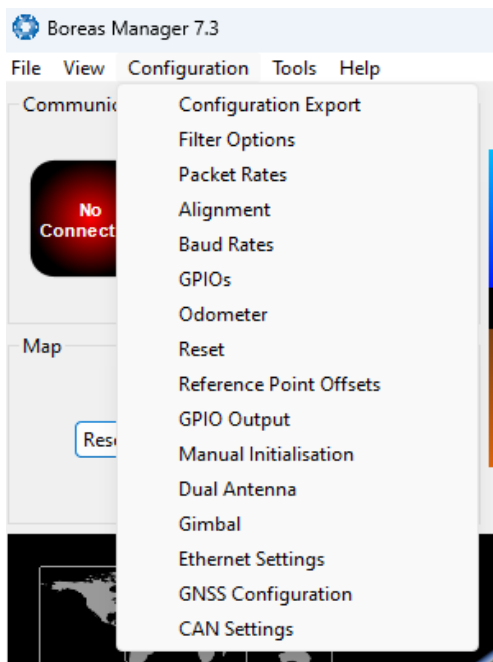

Figure 63: Manager Configuration Menu

9.2.7.1 Configuration Export

The Configuration Export dialogue can be used to export all the Boreas settings to a file. This file can be imported at a later date or on other units. This is useful to restore a unit to a pre set configuration at a later date or for batch configuration of multiple units.

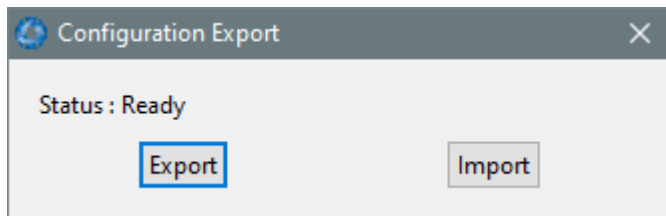

Figure 64: Manager Configuration Export Dialogue

9.2.7.2 Filter Options

For most applications the default filter options should be used and only the vehicle profile set. If in doubt please contact support@advancednavigation.com.

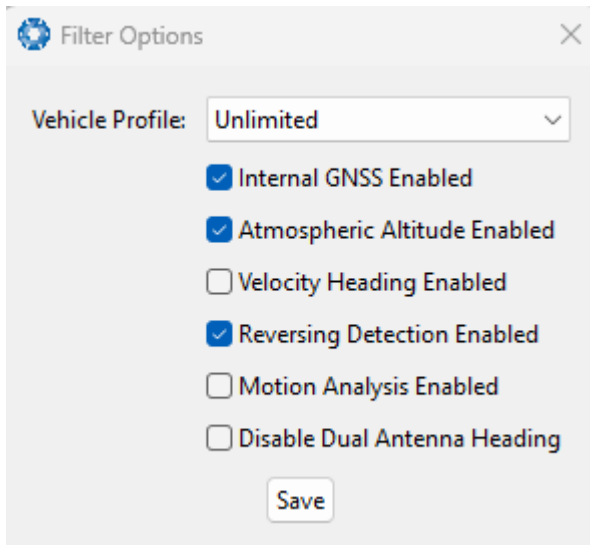

Figure 65: Manager Filter Options

9.2.7.3 Packet Rates

The Packet Rates dialogue allows the user to specify which packets output on a periodic basis and at what rate. The default packets enabled are the System State Packet (ID 20) and the Raw Sensors Packet (ID 28) at 20Hz and these typically provide all the data that a user will require. These two packets need to be enabled for the data graphs to update in Boreas Manager. Other state packets can be enabled as required.

Note: Packet rate configuration applies only to the data port which the Manager is connected to. To configure other ports, the Manager must be connected to that port.

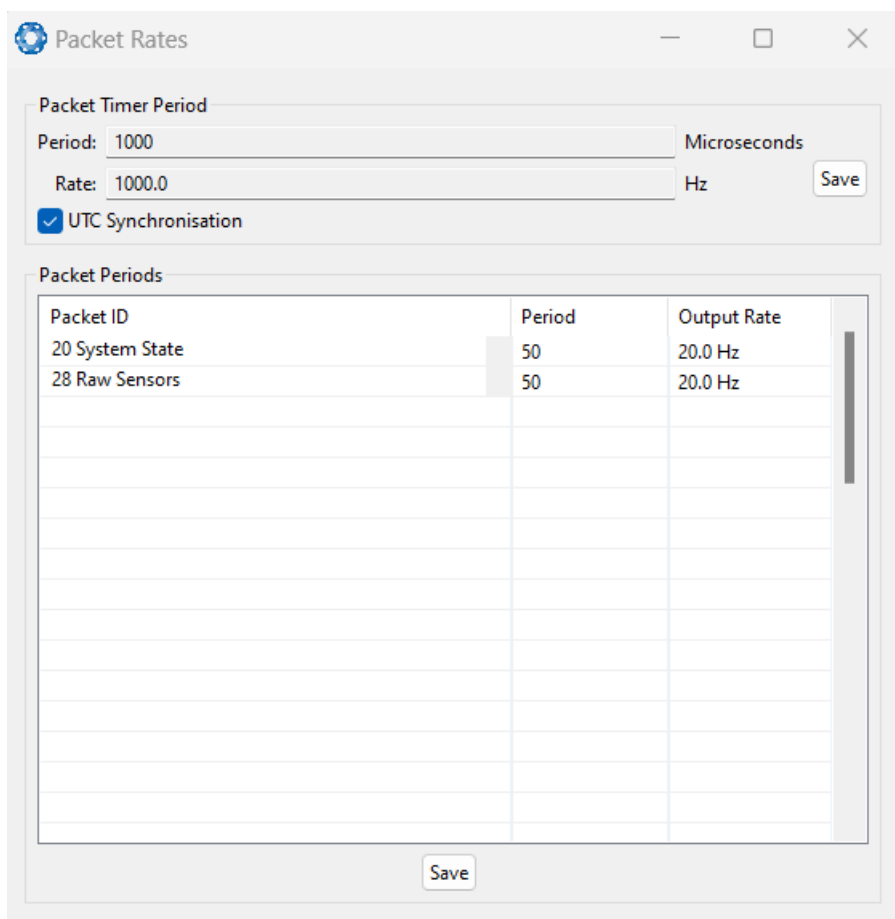

Figure 66: Manager Packet rates

9.2.7.4 Alignment

The Alignment dialogue is used to set the alignment offsets of the system installation. It is important to set the values in this dialogue correctly for accurate results. For most applications only the GNSS antenna offset values need to be entered and the rest of the values can be left at their factory defaults of zero.

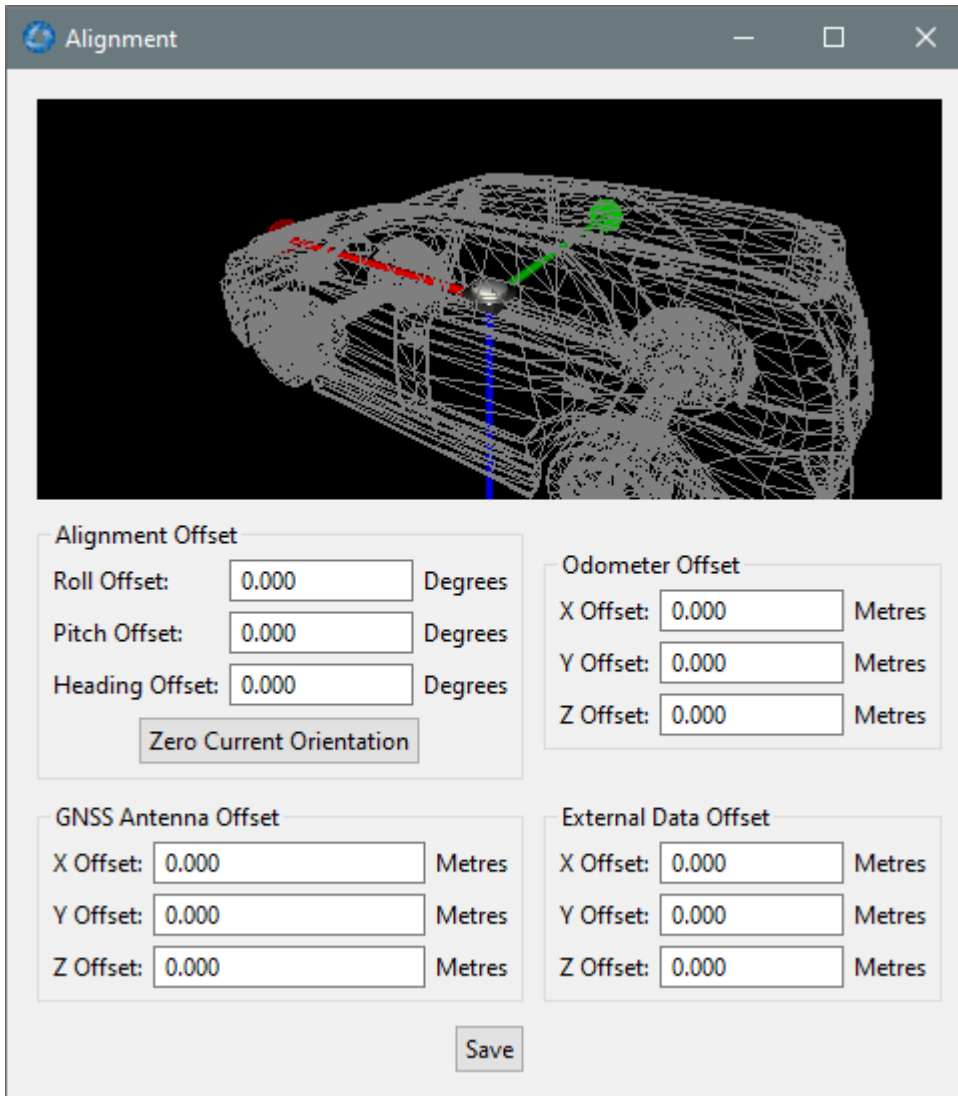

Figure 67: Manager Alignment Dialogue

Alignment Offset

If Boreas is installed into the vehicle with the positive X-axis pointing forwards and the positive Z-axis pointing down, then no alignment offset is required and the roll, pitch and heading offset values can remain at the factory defaults of zero.

If the unit is installed in a different orientation then the roll, pitch and heading offset must be entered. For example if the unit is installed on its side with the X-axis pointing up and the Z-axis pointing forwards and no change to the Y-axis, then this would result in a pitch offset of +90 degrees with roll and heading remaining zero.

If there is a small misalignment due to mechanical mounting error this can be compensated for by setting the vehicle stationary on a level surface and pressing the **Zero Current Orientation** button.

Note: Zero Current Orientation will only correct for roll and pitch offsets, the Heading offset must be entered manually and saved before using this function.

All the other offsets will be measured in the realigned body co-ordinate frame (X positive forward, Z positive down) after being corrected for any alignment offset entered.

GNSS Antenna Offset

The GNSS antenna offset is measured from the centre of the Boreas unit to the phase centre of the primary antenna in the orientation of the [12.3 The Body Co-ordinate Frame](#) (X positive forward, Z positive down).

Odometer Offset

The odometer offset is measured from the centre of the Boreas unit to the point at which the vehicle's tyre being measured makes contact with the road in the body co-ordinate frame (X positive forward, Z positive down).

If your odometer is not measuring a specific wheel, the offset should be to the point on the ground beneath the measurement point. If, for example, your car is a front wheel drive and you are using the velocity from the car OBDII port, the measurement point would be midway between the two front wheels.

External Data Offset

These values are only required for specialty applications operating with an external source of velocity data. The offsets are used when providing NMEA Input, External GNSS, or with an Air Data Unit. When using a DVL, use the odometer offset. Contact support@advancednavigation.com for assistance with these values.

9.2.7.5 Baud Rates

Some machines running Microsoft Windows do not support higher baud rates. When changing baud rates, it is recommended to test the baud rate configuration first, without ticking the Permanent box. This way, if it is not possible to communicate at the higher baud rate, a power cycle can be used to revert to the previous baud rate setting.

The factory default baud rate value for these ports is 115200 bps.

The primary and auxiliary ports can be set to RS232 or RS422. The factory default is RS232 for both ports.

Figure 68: Manager Baud Rates Dialogue

9.2.7.6 GPIO

This page allows the user to configure the input and output functions of the GPIO and Auxiliary ports. These functions are described in detail in [10.6.1 Dynamic Pin Functions](#). These functions change dynamically and are effective immediately upon clicking **Save Changes**.

Note: The GPIO port functions at RS232 levels for data functions and 0 to 5 volt (or 0 to 3.3 V) levels for all other functions. The auxiliary port functions at RS232 or RS422 levels for data functions and 0 to 5 volt (or 0 to 3.3 V) levels for all other functions. The internal hardware automatically reconfigures based upon the selected function.

The default values for these settings are Inactive. The dedicated 1PPS signal is active by default.

Figure 69: Manager GPIO configuration Dialogue

9.2.7.7 Odometer

The Odometer dialogue allows the user to configure the odometer pulse length and view the real time odometer data to verify correct operation. See [7.9 Odometer](#) and [8.8 Odometer Pulse Length](#) for more information on the use of odometers. The odometer offset is also applied when using a DVL input.

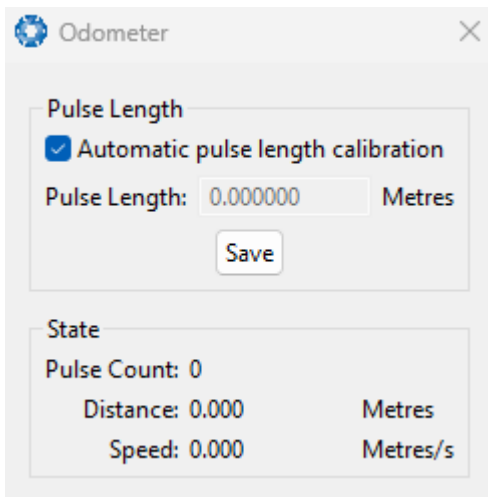

Figure 70: Manager Odometer Dialogue

9.2.7.8 Reset

The Reset button causes the system to perform a power cycle. No configuration settings or state data are lost. The Cold Start button clears all filters, and connections are reset and must re-established. No configuration settings are lost. The Factory Restore button resets all Boreas settings back to their factory defaults, including state data and all configuration settings. It also erases the hot start data so that the system is forced to perform a cold start.

Note: A Factory Restore will re-enable the DHCP Client and lose any static IP address settings.

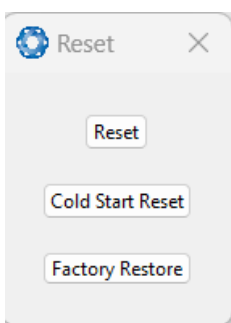

Figure 71: Manager Reset Dialogue

9.2.7.9 Reference Position Offsets

The Reference Point Offsets dialogue allows the user to set measurement points away from its default position at the physical centre of the Boreas unit. The primary reference point offset applies to data from all ANPP packets as well as all peripheral output such as NMEA messages and Heave Point 1.

When the values are zero the measurement point is the centre of the Boreas unit. This can be offset to a different position on the profile by entering the offset value from the centre of the Boreas unit to the desired position in the body co-ordinate frame (X positive forwards, Z positive down).

The Centre of Gravity (COG) Lever Arm Offset should be used to define where the centre of gravity is for the vehicle. It is useful in applications, such as a surface vessels, to improve the ability of the [8.4 Heading Sources](#) to complete coarse alignment.

These offsets are applied to the values in the [11.4.35 Heave Packet](#) and [11.4.44 Vessel Motion Packet](#).

Note: These values only apply to the Heave Packet and Vessel Motion Packet. NMEA, TSS and Simrad heave is not affected by the values in this dialogue which are always measured at the centre of the Boreas unit.

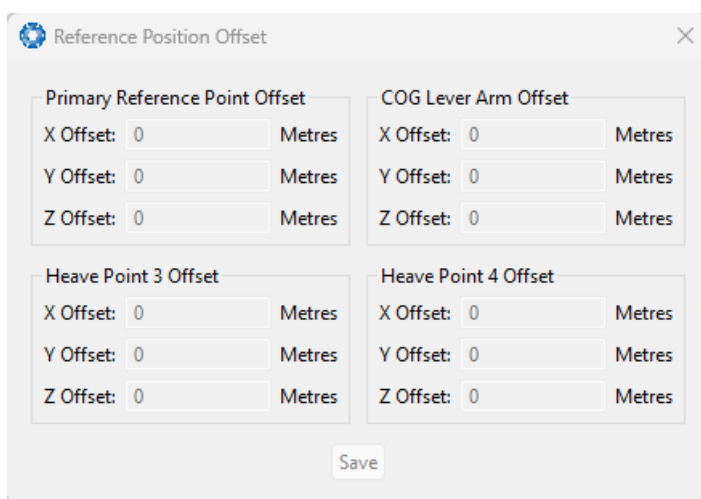

Figure 72: Manager Reference Position Offset

9.2.7.10 GPIO Output

The GPIO output configuration dialogue allows the user to configure the NMEA0183, TSS1 and SIMRAD output rates for the GPIO and Auxiliary port. These output rates will be observed with respect to the actual output selected in the [9.2.7.6 GPIO](#) port configuration.

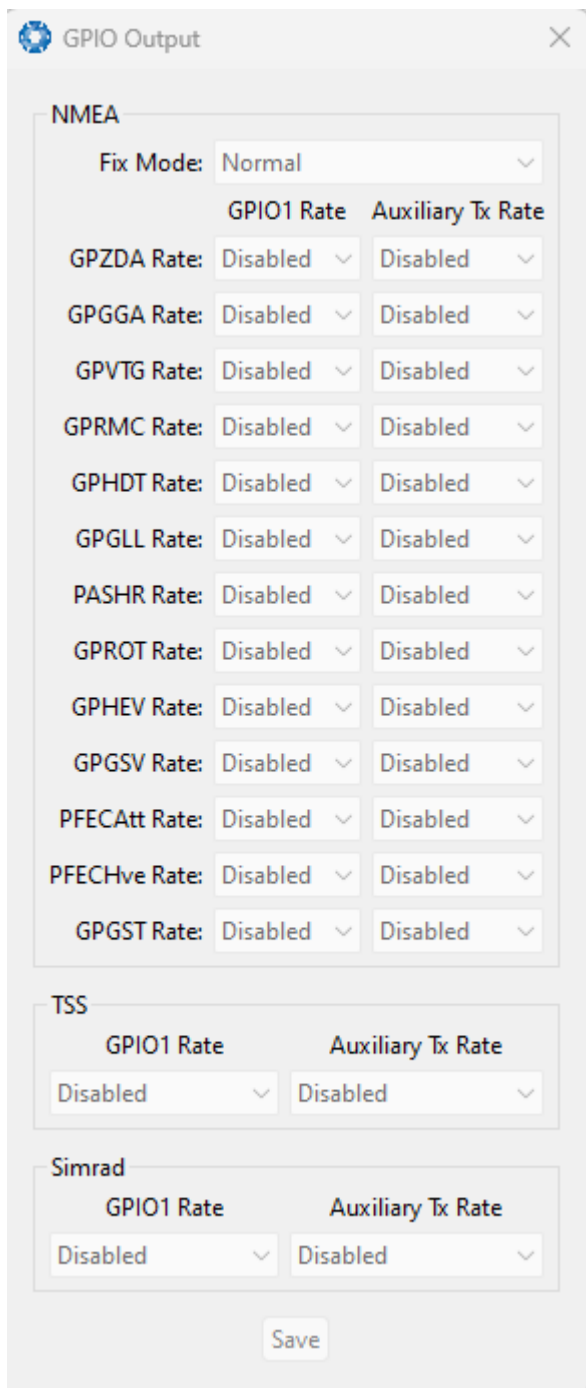

Figure 73: Manager GPIO Output Dialogue

9.2.7.11 Manual Initialisation

The Manual Initialisation dialogue can be used to manually initialise Boreas when a GNSS fix is not available. Setting the position will initialise the navigation filter. Setting the heading will also initialise the heading filter.

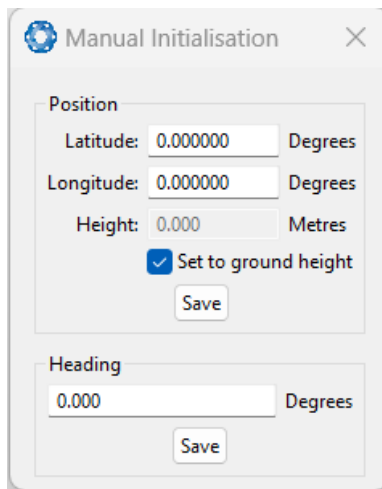

Figure 74: Manual Initialisation Dialogue

9.2.7.12 Gimbal

The Gimbal configuration dialogue is only used in gimbal specific applications.

Contact support@advancednavigation.com for more information on using Boreas inside a gimbal.

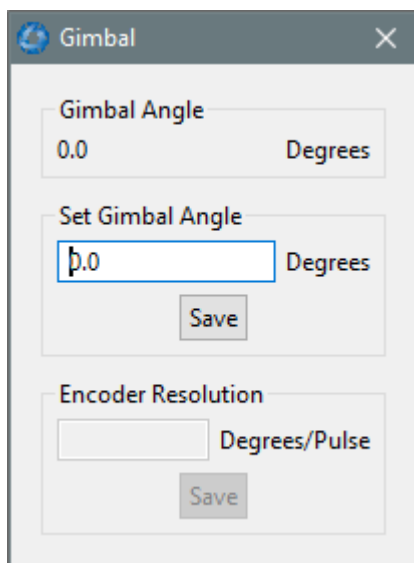

Figure 75: Manager Gimbal Dialogue

9.2.7.13 Ethernet Settings

The Ethernet Settings dialogue allows the user to enable or disable the DHCP Client. When the DHCP Client is disabled you need to enter the TCP/IP settings if the user wishes to access the web UI. If the user is connecting to Boreas via the primary port these settings can be ignored. The default is for the Ethernet mode to be set to DHCP.

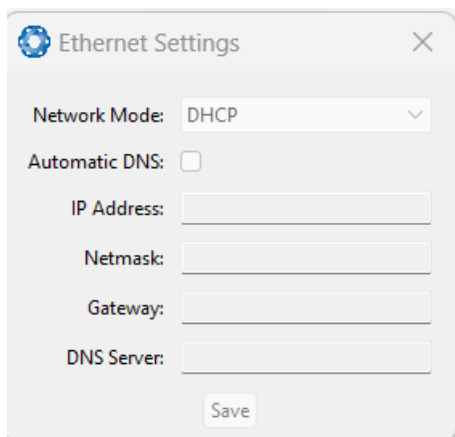

Figure 76: Manager Ethernet Settings Dialogue

9.2.7.14 CAN Settings

The CAN Settings page allows you to enable or disable the CAN functionality. If the user is connecting to Boreas via the primary port then these settings can be ignored. The default for CAN is Enabled at 1,000,000 baud rate. A CANOpen EDS file is available. Contact support@advancednavigation.com to obtain a copy of this file.

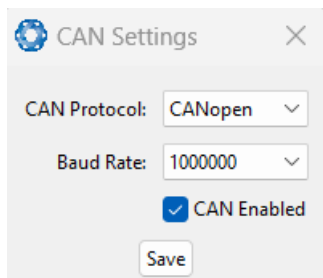

Figure 77: Manager CAN Settings Dialogue

9.2.8 Tools Menu

The **Tools** menu contains tools for performing certain procedures with Boreas.

Figure 78:

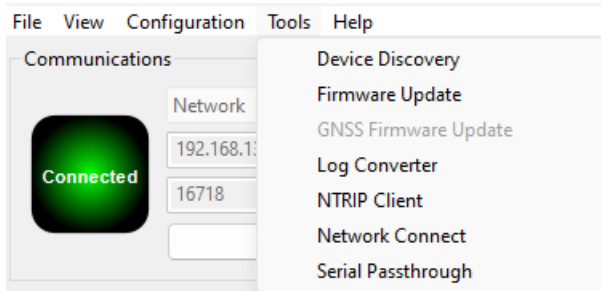

Figure 79: Manager Tools Menu

9.2.8.1 Firmware Update

This dialogue is used to update the Boreas device firmware.

Boreas contains firmware which is regularly updated to improve performance and add features. Advanced Navigation recommends that you upgrade to the latest version whenever available. The firmware update function is robust, such that power loss, file corruption or other issues cannot cause problems with units. Check the [Boreas](#) product page of the Advanced Navigation website periodically for updates.

Note: Advanced Navigation device firmware files have the extension .anfw.

After the appropriate file is uploaded, the Firmware Update dialogue will display "**Firmware Update Ready**" in the status line.

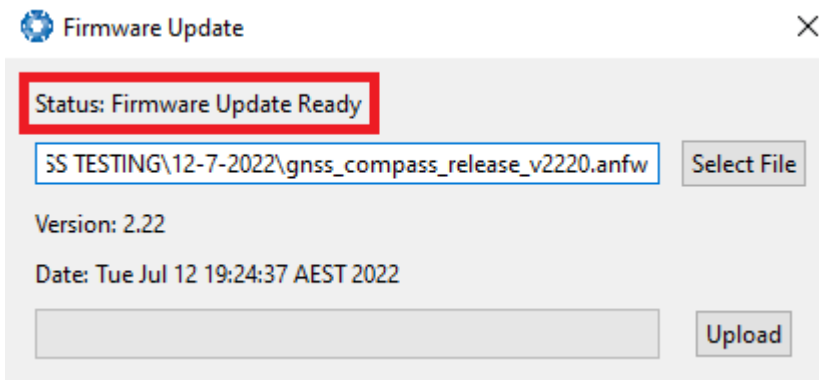

Figure 80: Firmware Update Ready Dialogue

Once the user clicks "upload", the dialogue status line will update to **"In Progress"**

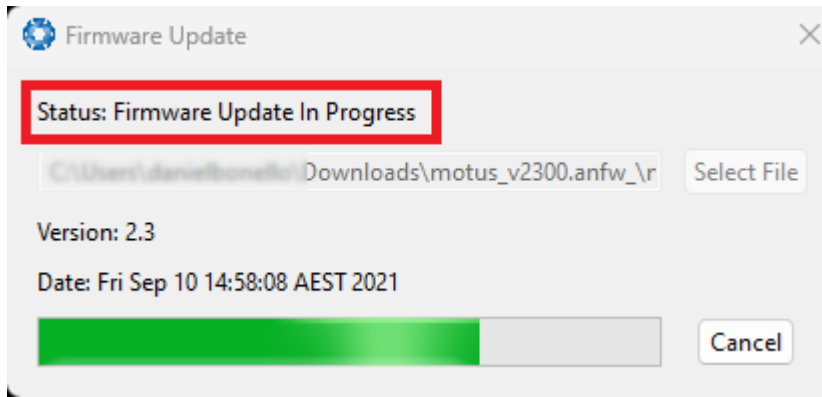

Figure 81: Firmware Update In Progress Dialogue

During this process, the user will notice the connection indicator change from **"Connected"** to **"Bootloader."** This change confirms that the upload is functioning properly.

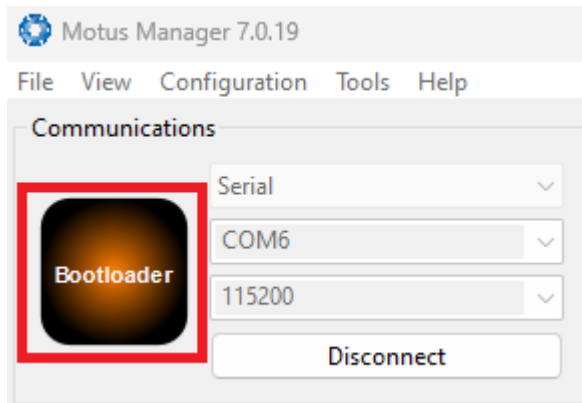

Figure 82: Firmware Update Bootloader Indicator

After the upload finishes, the system will restart. The device indicator will then display "**Connected**," and the firmware update status line will show "**Complete**."



Figure 83: Firmware Update Complete Dialogue

After the update, the user can close the firmware update dialogue and verify the update by looking at the version in the Device Information dialogue, found under the view menu of the manager.

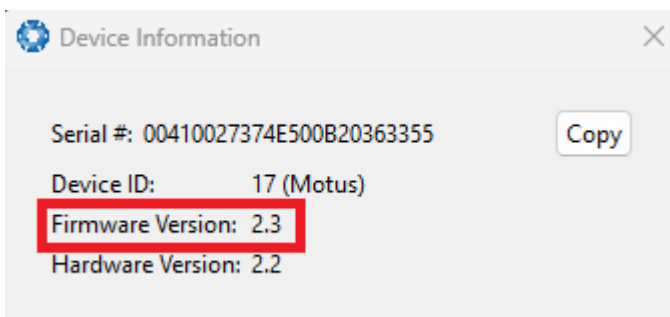

Figure 84: Device Information Dialogue

9.2.8.2 Log Converter

This tool allows the user to convert Boreas log files into various standard formats that are interchangeable and readable by many programs. The Position Offset settings are used to project the exported position of origin to a point other than the actual centre of the Boreas unit. For most users, these values should be left at zero.

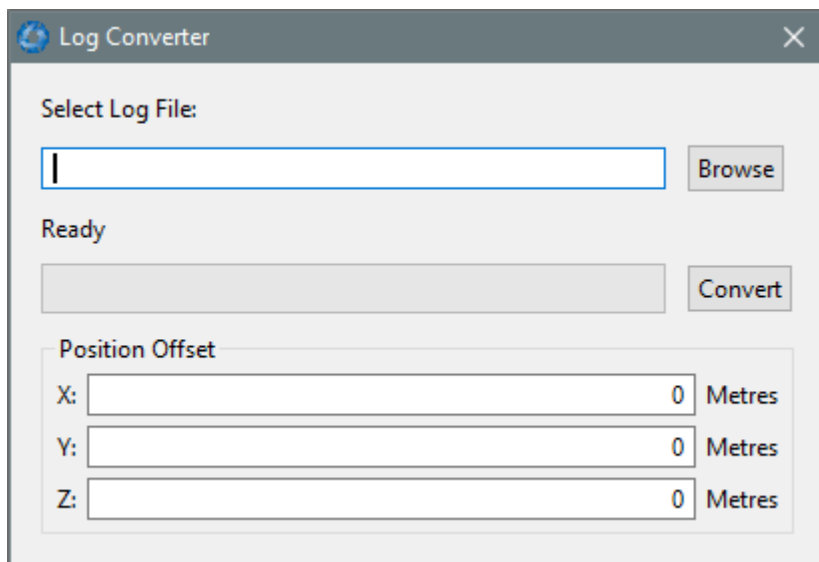

Figure 85: Manager Log Converter Dialogue

To configure the Log path, navigate to *Settings*, under the File menu.

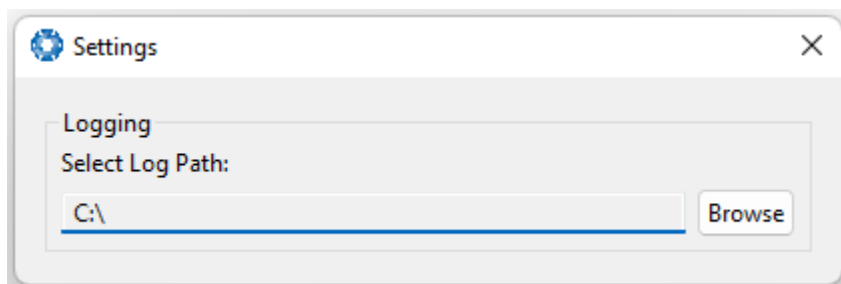
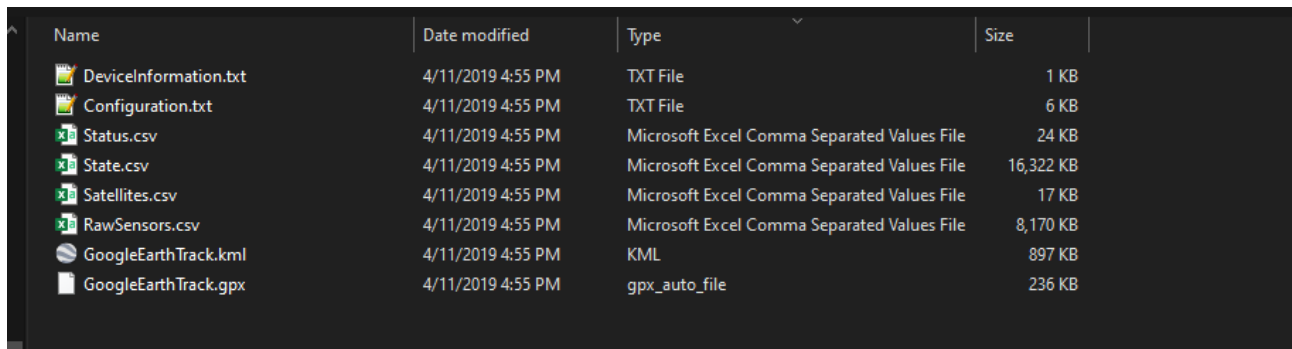

Figure 86: Settings menu for configuring Log Path

9.2.9 Logging

Boreas Manager features a fully automatic logging system. Every time the serial port **Connect** button is clicked Boreas Manager starts a new log file in the current directory. The log file is given the file name `BoreasLog_date_time.anpp` and contains all of the raw data received from Boreas in the AN packet protocol. The log files are closed when the serial port is disconnected.

To convert these log files into easily accessible formats, the [9.2.8.2 Log Converter](#) dialogue in the **Tools** menu can be used. The Log Converter creates a folder and generates files in the CSV (comma separated values) format that can be easily opened with Microsoft Excel, Matlab, LibreOffice and most other data analysis programs. It also creates a GPX file and a KML file that are designed to be opened with [Google Earth Pro](#).



Name	Date modified	Type	Size
DeviceInformation.txt	4/11/2019 4:55 PM	TXT File	1 KB
Configuration.txt	4/11/2019 4:55 PM	TXT File	6 KB
Status.csv	4/11/2019 4:55 PM	Microsoft Excel Comma Separated Values File	24 KB
State.csv	4/11/2019 4:55 PM	Microsoft Excel Comma Separated Values File	16,322 KB
Satellites.csv	4/11/2019 4:55 PM	Microsoft Excel Comma Separated Values File	17 KB
RawSensors.csv	4/11/2019 4:55 PM	Microsoft Excel Comma Separated Values File	8,170 KB
GoogleEarthTrack.kml	4/11/2019 4:55 PM	KML	897 KB
GoogleEarthTrack.gpx	4/11/2019 4:55 PM	gpx_auto_file	236 KB

Figure 87: Files Generated by the Log Converter

Note: This data logging is performed by the Boreas Manager application and is separate from the Boreas inbuilt logging functionality accessible via the web UI.

9.3 Using the Android App

The Spatial Manager Android app provides logging and visualisation functions for Android phones and tablets. It is particularly useful for field testing purposes. You can use this app to connect to your Boreas via Bluetooth and:

- Monitor position and orientation in real time
- Log real-time data for later analysis and review
- Configure NTRIP stream corrections
- Configure device alignment offsets and manual initialisation

You will require a Serial to Bluetooth adaptor with Bluetooth v2.0 support connected to the primary serial port.

The app can be found by searching the Google Play store for "Advanced Navigation Spatial Manager". Refer to the in-app Quick Start guide for more information. Contact support@advancednavigation.com if you have any questions about the Android app.

9.4 Using ANPP

Boreas can be configured and monitored using the Advanced Navigation Packet Protocol (ANPP), which is detailed fully in [11 Advanced Navigation Packet Protocol](#).

A software development kit (SDK) is available at no extra charge to assist you when developing your own applications. It contains example code in a number of programming languages, ready to compile and test. This is available from the Boreas [product page](#).

10 Interfacing

Communication with Boreas is possible on the following ports:

- [10.1 Ethernet](#)
- [10.2 Serial Interface](#)
- [10.4 CAN Interface](#)
- [10.3 1PPS Signal](#)
- [10.6 GPIO Pins and the Auxiliary Port](#)

Each port has different input and output capabilities.

10.1 Ethernet

The Ethernet interface offers a 100 MBit port for connection to a network, router or laptop/computer. The interface offers a [Web UI](#), as well as 4 (four) configurable data ports. Each Data Port

- can be configured as a TCP Server, TCP Client or a UDP Client as detailed in [10.1.1 Ethernet Modes](#)
- can be configured with an Input and/or Output for a number of protocols as detailed in [10.1 Ethernet](#).
- should only be used to establish a connection with a single remote computer/device at any one time.

10.1.1 Ethernet Modes

Ethernet Mode	Description	Required Configuration
TCP Server	Boreas will establish a TCP Server listening on the defined port. A connected client is able to receive Output data and send Input data based on the defined Input and Output functions.	Port
TCP Client	Boreas will continuously attempt to establish a TCP connection to the defined Destination IP and Port. Once established, a connected client is able to receive Output data and send Input data based on the defined Input and Output functions.	Client Destination IP address Port
UDP Client	Boreas will send UDP Output data to the defined Destination IP and Port. A client can also send UDP Input data to Boreas this same Port.	Client Destination IP address Port

Table 28: Ethernet Data Port Modes

10.1.2 Ethernet Functions

Function Type	Name
Ethernet Input	10.1.2.1 NMEA Input
	10.1.2.19 GNSS Receiver Passthrough
	10.1.2.2 Novatel GNSS Input
	10.1.2.3 Topcon GNSS Input
	10.1.2.4 ANPP Input
	10.1.2.5 RTCM Differential GNSS Corrections Input
	10.1.2.6 Trimble GNSS Input
	10.1.2.7 u-blox GNSS Input
	10.1.2.8 Hemisphere GNSS Input
	10.1.2.9 Teledyne DVL Input
	10.1.2.10 Trittech USBL Input
	10.1.2.11 Linkquest DVL Input
10.1.2.12 Nortek DVL Input	
Ethernet Output	10.1.2.13 NMEA Output
	10.1.2.14 ANPP Output
	10.1.2.15 TSS1 Output
	10.1.2.16 Simrad 1000 Output
	10.1.2.17 Simrad 3000 Output
	10.1.2.18 Serial Port Passthrough
	10.1.2.19 GNSS Receiver Passthrough

Table 29: Ethernet Data Port Functions

10.1.2.1 NMEA Input

Description: This function accepts external data in the NMEA 0183 format. Advanced Navigation recommends against using NMEA 0183 input wherever possible due to the inefficiency, low accuracy and precision and weak error checking of the format. All NMEA messages received must have a valid checksum. Supported messages are listed below. The recommended combination of messages are RMC with optional messages GPGSV and GPGSA. If RMC is not available, GGA and VTG can be used.

Message ID	Description	Notes
GPGGA GNGGA	3D position	All constellations
GPGLL GNGLL	2D position	All constellations
GPRMC GNRMC	2D position, 2D velocity and coarse time	All constellations
GPVTG GNVTG	2D velocity	All constellations
GPHDT GNHDT HEHDT	Heading	All constellations
GPGSV GNGSV	Satellites	Only GPS (GPGSV)
GPGSA GNGSA	Dilution of Precision	
xxPIPS	Depth below surface	
xxVBW	Water speed, ground speed	
xxHDM	Magnetic heading	
PSIMSSB	SSBL position	
xxVHW	Water speed and heading	
xxDBS	Depth below surface	

Table 30: Supported NMEA messages

10.1.2.2 Novatel GNSS Input

Description: This function is designed for interfacing Boreas with a Novatel GNSS receiver. It accepts data in the Novatel binary format and requires messages BESTPOS and BESTVEL at rates higher than 1 Hz (20Hz recommended). The message BESTSATS is optional to display detailed satellite information. The message HEADING is also supported for ALIGN capable receivers.

10.1.2.3 Topcon GNSS Input

Description: This function is designed for interfacing Boreas with a Topcon GNSS receiver. It accepts data in the GRIL TPS binary format and expects messages PG and VG at rates higher than 1 Hz.

10.1.2.4 ANPP Input

Description: This function accepts data in the ANPP format as specified in [11 Advanced Navigation Packet Protocol](#).

10.1.2.5 RTCM Differential GNSS Corrections Input

Description: This function accepts RTCM v3 GNSS corrections messages. This allows for Differential GNSS or RTK with the Boreas internal GNSS receiver.

10.1.2.6 Trimble GNSS Input

Description: This function is designed for interfacing Boreas with an external Trimble GNSS receiver. It accepts data in the Trimble binary format GSOF and expects packet 0x40 with records 1, 2, 8, and 12 at rates higher than 1Hz (20Hz recommended) and optional records 9 and 34 at 1 to 2Hz.

10.1.2.7 u-blox GNSS Input

Description: This function is designed for interfacing Boreas with an external u-blox GNSS receiver. It accepts data in the u-blox binary format and expects message NAV-PVT at rates higher than 1Hz.

10.1.2.8 Hemisphere GNSS Input

Description: This function is designed for interfacing Boreas with an external Hemisphere GNSS receiver. It accepts data in the Hemisphere binary format and expects message Bin1 at rates higher than 1Hz. For Hemisphere receivers that provide heading using two antennas, NMEA should be used instead as the binary format does not allow for transmission of heading information.

10.1.2.9 Teledyne DVL Input

Description: This function accepts DVL data from a Teledyne DVL. For assistance with configuration, contact [Support](#).

10.1.2.10 Trittech USBL Input

Description: This function accepts USBL data from a Trittech USBL. For assistance with configuration, contact [Support](#).

10.1.2.11 Linkquest DVL Input

Description: This function accepts DVL data from a Linkquest DVL. The DVL should be configured to output in NQ1 format. For assistance with configuration, contact [Support](#).

10.1.2.12 Nortek DVL Input

Description: This function accepts DVL data in the Nortek DVL binary format. It accepts the packets 0x1B (DVL Bottom Track) and 0x1D (DVL Water Track). The recommended update rate is 8Hz.

10.1.2.13 NMEA Output

Descrip- This function outputs a configurable combination of the NMEA messages GPZDA, GPGGA, GPVTG, GPRMC, GPHDT, PASHR, GPROT, GPHEV, GPGSV, PFECGPAtt, and PFECGPHve at

tion: up to 50 Hz. The messages output and the output rate can be configured using the web UI or Boreas Manager. An example output is shown below.

```
$GPZDA,031644.460,07,05,2013,00,00*52
$GPGGA,031644.460,3352.3501851,S,15112.2355488,E,6,00,1.4,150.0,M,0.0,M,,*7E
$GPVTG,089.19,T,089.19,M,000.00,N,000.00,K,E*27
$GPRMC,031644.460,A,3352.3501851,S,15112.2355488,E,0.0,89.2,070513,12.5,W,E*02
$GPHDT,89.2,T*06
$PASHR,031644.460,089.19,T,-00.01,-00.47,-00.00,,,,,0,0*2E
```

10.1.2.14 ANPP Output

Description: This function outputs data in the ANPP format as specified in [11 Advanced Navigation Packet Protocol](#). This function is for ANPP peripheral devices only.

10.1.2.15 TSS1 Output

Description: This function outputs the TSS1 format at a user configurable rate of up to 50 Hz. The output rate can be configured using the page in the web UI.

10.1.2.16 Simrad 1000 Output

Description: This function outputs the Simrad 1000 format at a user configurable rate of up to 50 Hz. The output rate can be configured using the [9.1.3.2 Data Ports](#) page in the [9.1 Using the Web User Interface](#).

10.1.2.17 Simrad 3000 Output

Description: This function outputs the Simrad 3000 format at a user configurable rate up to 50 Hz. The output rate can be configured using the [9.1.3.2 Data Ports](#) page in the [9.1 Using the Web User Interface](#).

10.1.2.18 Serial Port Passthrough

Description: This function allows passthrough communication through either GPIO 1 and 2 or the Auxiliary port. To transmit data use the [11.3.7 Serial Port Passthrough Packet](#). When data is received it will be sent back using the same [11.3.7 Serial Port Passthrough Packet](#).

10.1.2.19 GNSS Receiver Passthrough

Description: This function allows for pass through connection to the internal GNSS receiver. This is useful for firmware updates of the internal GNSS receiver.

10.2 Serial Interface

There are two serial ports available for use. The GPIO port can also be used as a serial port, with less functionality.

Model	Primary Port	Auxiliary Port	GPIO Port
Boreas	ANPP only over RS232 or RS422. No dynamic pin functions	ANPP over RS232 or RS422, 10.6.1 Dynamic Pin Functions	ANPP over RS232, 10.6.1 Dynamic Pin Functions

Table 31: I/O Ports Available

10.2.1 Baud Rate

The default baud rate of Boreas is 115,200. The primary and auxiliary port baud rate can be set anywhere from 4,800 to 4,000,000 baud and can be modified using the Baud Rates page in the web UI or Boreas Manager. The GPIO port baud rate can be set anywhere from 4,800 to 250,000 baud. It is important to select a baud rate that is capable of carrying the amount of data that Boreas has been configured to output. See [11.1.4 Packet Rates](#) for more details on the data output calculation. The data rate in bytes per second can be calculated by dividing the baud rate by 10. For example if the baud rate is 115,200, the data rate is 11,520 bytes per second. If the selected data rate is insufficient, data may be lost without warning.

The support team can provide a baud rate calculator if it is required. For more information or assistance, contact technical support via email at support@advancednavigation.com.

10.2.2 Format

The format is fixed at 1 start bit, 8 data bits, 1 stop bit and no parity. See [11 Advanced Navigation Packet Protocol](#) for details on the ANPP protocol.

10.3 1PPS Signal

There is a dedicated 1PPS signal available on the [6.7 IO Connection](#). See the [9.1.3.12 Advanced](#) section of the Configuration Menu for information on changing 1PPS and GPIO settings, and see [10.6.1 Dynamic Pin Functions](#) for information on 1PPS and GPIO output voltage.

The 1PPS signal reference ground is the GPIO ground domain. See [7.7 Electrical Domains](#) for more information.

The signal is normally low and pulses high for 100 milliseconds to signal the precise second, which starts on the rising edge of the signal.

This dedicated 1PPS signal is the recommended 1PPS signal to use as it is more accurate. The validity of this 1PPS signal can be monitored using the time initialised status flag.

10.4 CAN Interface

The CAN interface is available on the Connector Pin-out, and is used for low-level device integration with other vehicle systems.

A CANopen EDS file is available. Contact the Advanced Navigation support team at support@advancednavigation.com for a copy of this.

10.5 External Data

External sources of position, velocity and/or heading can be integrated into the Boreas filter solution. The data can be sent to Boreas in the ANPP format over the primary (RS232 or RS422), auxiliary (RS232 or RS422) or GPIO ports (RS232 only) or in a number of different formats. If using the ANPP format, use the table below to find the relevant section.

Packet
11.4.24 External Position and Velocity Packet
11.4.25 External Position Packet
11.4.26 External Velocity Packet
11.4.27 External Body Velocity Packet
11.4.28 External Heading Packet
11.4.31 External Time Packet
11.4.32 External Depth Packet
11.4.36 External Odometer Packet
11.4.37 External Air Data Packet

Table 32: ANPP External Data Packets

10.6 GPIO Pins and the Auxiliary Port

In addition to the primary port and CAN port, Boreas contains two general purpose input/output (GPIO) pins and an auxiliary port on the IO Breakout Connector. These pins are multi function and can be used to extend Boreas with additional peripherals, sensors and data formats. Both GPIO pins have digital input, digital output, frequency input and frequency output functionality.

GPIO1 can also function as an RS232 (only) serial transmit line and GPIO2 can function as an RS232 (only) serial receive line. The GPIO serial baud rate can be configured anywhere from 4800 to 250 K baud. The auxiliary serial baud rate can be configured anywhere from 4800 to 4 M baud. See [11.5.3.1 Supported Baud Rate](#). Changes to these baud rates can be made by using the Baud Rates page in the [web UI](#) or [Boreas Manager](#).

The available GPIO and auxiliary functions are listed in the section [10.6.1 Dynamic Pin Functions](#). The function of a GPIO pin or the auxiliary port can be changed at any time using the GPIO Configuration page in the Boreas [web UI](#) or [Manager](#). GPIO 1 and GPIO 2 operate at standard voltage levels for digital input, digital output, frequency input and frequency output, but when a serial data function is selected, this GPIO pin automatically switches to RS232 voltage level.

10.6.1 Dynamic Pin Functions

Function Type	Name
Tristate	10.6.1.1 Inactive
Digital Output	10.6.1.2 1PPS Output
	10.6.1.3 GNSS Fix Output
Digital Input	10.6.1.4 Zero Velocity Input
	10.6.1.5 Disable GNSS
	10.6.1.6 Disable Pressure
	10.6.1.7 Set Zero Orientation Alignment
	10.6.1.8 System State Packet Trigger
	10.6.1.9 Raw Sensors Packet Trigger
	10.6.1.10 1PPS Input
	10.6.1.11 Event 1 Input
	10.6.1.12 Event 2 Input
	10.6.1.13 Odometer Direction, Forward Low
	10.6.1.14 Odometer Direction, Forward High
	10.6.1.15 Reverse Alignment, Forward Low
	10.6.1.16 Reverse Alignment, Forward High
	10.6.1.17 Zero Angular Velocity Input
Frequency Input	10.6.1.18 Odometer Input
	10.6.1.19 Pitot Tube Input
	10.6.1.20 Pressure Depth Transducer (deprecated)
	10.6.1.21 Left Wheel Speed Sensor
	10.6.1.22 Right Wheel Speed Sensor
	10.6.1.23 Wheel Speed Sensor
	10.6.1.24 Wheel Encoder Phase A
	10.6.1.25 Wheel Encoder Phase B
	10.6.1.26 Gimbal Encoder Phase A
10.6.1.27 Gimbal Encoder Phase B	

Function Type	Name
Serial Receive	10.6.1.28 NMEA Input
	10.6.1.29 Novatel GNSS Input
	10.6.1.30 Topcon GNSS Input
	10.6.1.31 ANPP Input
	10.6.1.32 RTCM Differential GNSS Corrections Input
	10.6.1.33 Trimble GNSS Input
	10.6.1.34 u-blox GNSS Input
	10.6.1.35 Hemisphere GNSS Input
	10.6.1.36 Teledyne DVL Input
	10.6.1.37 Trittech USBL Input
	10.6.1.38 Linkquest DVL Input
	10.6.1.39 Linkquest USBL Input
	10.6.1.40 Nortek DVL Input
Serial Transmit	10.6.1.41 NMEA Output
	10.6.1.42 ANPP Output
	10.6.1.43 TSS1 Output
	10.6.1.44 Simrad 1000 Output
	10.6.1.45 Simrad 3000 Output
Serial	10.6.1.46 Serial Port Passthrough
	10.6.1.47 GNSS Receiver Passthrough

Table 33: Dynamic Pin Functions

10.6.1.1 Inactive

Type: Tristate
GPIO Port: 1, 2
Auxiliary: All

10.6.1.2 1PPS Output

Type: Digital Output
GPIO Port: 1, 2
Auxiliary: Transmit
Description: There is a difference between the output of the GPIO and auxiliary ports when set to 1PPS output mode.

1PPS Source	Voltage Level	Trigger
Auxiliary	-5 V to 5 V	Falling Edge
GPIO	0 to 5 V, 0 to 3.3 V	Rising Edge

Figure 88: 1PPS Specifications

The pin is normally low and pulses high for 50 milliseconds to signal the precise second. The 1PPS line starts pulsing approximately 100 milliseconds after power up and always fires irrespective of whether Boreas has accurate time or not. It is important to note that when Boreas acquires time corrections from its GNSS receiver, the 1PPS signal may fire at an interval of less than 1 second. This typically only occurs the first time the GNSS receiver obtains a fix after startup. The time initialised status flag can be used to determine whether the time and 1PPS line is accurate or not.

The dedicated [10.3 1PPS Signal](#) on the Connector Pin-out or the auxiliary transmit are the recommended 1PPS signals as they have less jitter than the GPIO ports. The validity of the dedicated 1PPS signal can be monitored using the “time initialised” flag in the [11.4.1 System State Packet](#).

10.6.1.3 GNSS Fix Output

Type:	Digital Output
GPIO Port:	1, 2
Auxiliary:	Transmit
Description:	In this function, the pin is low when there is no GNSS fix or a 2D fix and high when there is a 3D, SBAS, Differential or RTK GNSS fix.

10.6.1.4 Zero Velocity Input

Type:	Digital Input
GPIO Port:	1, 2
Auxiliary:	Receive
Description:	When using this function, a high state indicates to Boreas that it is stationary. The low state indicates that the vehicle is not stationary. Use of this function can prevent drift during periods when a GNSS signal is not available.

10.6.1.5 Disable GNSS

Type:	Digital Input
GPIO Port:	1, 2
Auxiliary:	Receive
Description:	This function accepts a digital input with a low state enabling the GNSS and a high state disabling the GNSS.

10.6.1.6 Disable Pressure

Type:	Digital Input
--------------	---------------

GPIO Port:	1, 2
Auxiliary:	Receive
Description:	This function accepts a digital input with a low state enabling the atmospheric pressure sensor and a high state disabling the atmospheric pressure sensor.

10.6.1.7 Set Zero Orientation Alignment

Type:	Digital Input
GPIO Port:	1, 2
Auxiliary:	Receive
Description:	This function accepts a digital input. The input is normally low and a transition from low to high causes Boreas to set its alignment so that the current orientation is zero. Due to the risk of exhausting the flash cycles, the change is not permanent and will disappear on reset. To make it permanent the 11.5.4 Installation Alignment Packet must be read and then sent back to Boreas with the permanent flag set. This function requires de-bouncing if attached to a switch.

10.6.1.8 System State Packet Trigger

Type:	Digital Input
GPIO Port:	1, 2
Auxiliary:	Receive
Description:	This function accepts a digital input. The input is normally low and a transition from low to high causes Boreas to send the System State Packet. This function requires de-bouncing if attached to a switch.

10.6.1.9 Raw Sensors Packet Trigger

Type:	Digital Input
GPIO Port:	1, 2
Auxiliary:	Receive
Description:	This function accepts a digital input. The input is normally low and a transition from low to high causes Boreas to send the 11.4.9 Raw Sensors Packet . This function requires de-bouncing if attached to a switch.

10.6.1.10 1PPS Input

Type:	Digital Input
GPIO Port:	1, 2
Auxiliary:	Receive
Description:	This function is designed to allow external GNSS receivers to synchronise time with Boreas. It triggers on a transition from low to high.

10.6.1.11 Event 1 Input

Type:	Digital Input
GPIO Port:	1, 2
Auxiliary:	Receive
Description:	This function is designed to allow external events to be recorded by Boreas. The event is recorded in the Filter Status (see 11 Advanced Navigation Packet Protocol), and resets after the next packet is output. The event triggers on a transition from low to high.

10.6.1.12 Event 2 Input

Type:	Digital Input
GPIO Port:	1, 2
Auxiliary:	Receive
Description:	This function is designed to allow external events to be recorded by Boreas. The event is recorded in the Filter Status (see 11 Advanced Navigation Packet Protocol), and resets after the next packet is output. The event triggers on a transition from low to high.

10.6.1.13 Odometer Direction, Forward Low

Type:	Digital Input
GPIO Port:	1, 2
Auxiliary:	Receive
Description:	This function is designed to take a reversing indication input for direction with an odometer or wheel encoder. It should be used in combination with Odometer Input or Wheel Speed Sensor.

10.6.1.14 Odometer Direction, Forward High

Type:	Digital Input
GPIO Port:	1, 2
Auxiliary:	Receive
Description:	This function is designed to take a reversing indication input for direction with an odometer or wheel encoder. It should be used in combination with Odometer Input or Wheel Speed Sensor.

10.6.1.15 Reverse Alignment, Forward Low

Type:	Digital Input
GPIO Port:	1, 2
Auxiliary:	Receive
Description:	This function is designed to reverse the alignment settings for vehicles that can have two vehicle forward directions, such as locomotives.

10.6.1.16 Reverse Alignment, Forward High

Type: Digital Input
GPIO Port: 1, 2
Auxiliary: Receive
Description: This function is designed to reverse the alignment settings for vehicles that can have two vehicle forward directions, such as locomotives.

10.6.1.17 Zero Angular Velocity Input

Type: Digital Input
GPIO Port: 1, 2
Auxiliary: Receive
Description: In this function, a high state indicates to Boreas that the vehicle is not rotating. The low state indicates that the vehicle could be rotating. Use of this function can significantly improve heading drift performance when a GNSS signal is not available.

10.6.1.18 Odometer Input

Type: Frequency Input
GPIO Port: 1, 2
Auxiliary: Receive
Description: This function is designed for low-resolution vehicle speed sensors and odometers. It expects a normally low input with a high state for the trigger. If the pulse length is more than 0.1 metres then this odometer input function should be used. If it is less than 0.1 metres, the wheel speed sensor function should be used. Contact technical support at support@advancednavigation.com for help integrating with your speed sensor.

Parameter	Value
Trigger	Low → High
Maximum Frequency	600 Khz
Maximum Pulse Rate	4294967 pulses/metre

Table 34: Odometer Specifications

10.6.1.19 Pitot Tube Input

Type: Frequency Input
GPIO Port: 1, 2
Auxiliary: Receive
Description: This function allows fixed wing aircraft to measure airspeed to improve navigation performance. It requires a differential pressure sensor that has a frequency output such as the Kavlico P992 (frequency output option) or the Paroscientific series 5300. Contact technical support at support@advancednavigation.com for help integrating with a pitot tube.

10.6.1.20 Pressure Depth Transducer (deprecated)

Type: Frequency Input
GPIO Port: 1, 2
Auxiliary: Receive
Description: This function is designed for interfacing with a legacy pressure depth transducer. These are no longer available and the function is now deprecated.

10.6.1.21 Left Wheel Speed Sensor

Type: Frequency Input
GPIO Port: 1, 2
Auxiliary: Receive
Description: This function is designed for the left wheel of a vehicle with dual wheel speed sensors.

10.6.1.22 Right Wheel Speed Sensor

Type: Frequency Input
GPIO Port: 1, 2
Auxiliary: Receive
Description: This function is designed for the right wheel of a vehicle with dual wheel speed sensors.

10.6.1.23 Wheel Speed Sensor

Type: Frequency Input
GPIO Port: 1, 2
Auxiliary: Receive
Description: This function is designed for high resolution vehicle speed sensors and wheel speed sensors. It expects a normally low input with a high state for the trigger. If the pulse length is more than 0.1 metres the odometer input function should be used, if it is less than 0.1 metres the wheel speed sensor function should be used. Contact technical support via email at support@advancednavigation.com for with help integrating with your speed sensor.

Parameter	Value
Trigger	Low → High
Maximum Frequency	40 MHz
Maximum Pulse Rate	4,294,967,295 pulses/metre

Table 35: Wheel Speed Sensor Specifications

10.6.1.24 Wheel Encoder Phase A

Type: Frequency Input

GPIO Port:	1, 2
Auxiliary:	N/A
Description:	This function is designed for rotary incremental quadrature encoders. It should be used in combination with Wheel Encoder Phase B.

10.6.1.25 Wheel Encoder Phase B

Type:	Frequency Input
GPIO Port:	1, 2
Auxiliary:	N/A
Description:	This function is designed for rotary incremental quadrature encoders. It should be used in combination with Wheel Encoder Phase A.

10.6.1.26 Gimbal Encoder Phase A

Type:	Frequency Input
GPIO Port:	1, 2
Auxiliary:	N/A
Description:	This function is designed for interfacing with a rotary incremental quadrature encoder to measure the azimuth angle of a gimbal in which Boreas is installed. It should be used in combination with Gimbal Encoder Phase B.

10.6.1.27 Gimbal Encoder Phase B

Type:	Frequency Input
GPIO Port:	1, 2
Auxiliary:	N/A
Description:	This function is designed for interfacing with a rotary incremental quadrature encoder to measure the azimuth angle of a gimbal in which Boreas is installed. It should be used in combination with Gimbal Encoder Phase A .

10.6.1.28 NMEA Input

Type:	Serial Receive
GPIO Port:	2
Auxiliary:	Receive
Description:	This function accepts external data in the NMEA 0183 format. Advanced Navigation recommends against using NMEA 0183 input wherever possible due to the inefficiency, low accuracy and precision and weak error checking of the format. All NMEA messages received must have a valid checksum. Supported messages are listed below. The recommended combination of messages are RMC with optional messages GPGSV and GPGSA. If RMC is not available, GGA and VTG can be used.

Message ID	Description	Notes
GPGGA GNGGA	3D position	All constellations
GPGLL GNGLL	2D position	All constellations
GPRMC GNRMC	2D position, 2D velocity and coarse time	All constellations
GPVTG GNVTG	2D velocity	All constellations
GPHDT GNHDT HEHDT	Heading	All constellations
GPGSV GNGSV	Satellites	Only GPS (GPGSV)
GPGSA GNGSA	Dilution of Precision	
xxPIPS	Depth below surface	
xxVBW	Water speed, ground speed	
xxHDM	Magnetic heading	
PSIMSSB	SSBL position	
xxVHW	Water speed and heading	
xxDBS	Depth below surface	

Table 36: Supported NMEA messages

10.6.1.29 Novatel GNSS Input

Type: Serial Receive

GPIO Port: 2

Auxiliary: Receive

Description: This function is designed for interfacing Boreas with a Novatel GNSS receiver. It accepts data in the Novatel binary format and requires messages BESTPOSB and BESTVELB at rates higher than 1 Hz (20 Hz recommended). The message BESTSATSB is optional to display detailed satellite information. The message HEADING is also supported for ALIGN capable receivers.

10.6.1.30 Topcon GNSS Input

Type: Serial Receive

GPIO Port: 2

Auxiliary: Receive

Description: This function is designed for interfacing Boreas with a Topcon GNSS receiver. It accepts data in the GRIL TPS binary format and expects messages PG and VG at rates higher than 1 Hz.

10.6.1.31 ANPP Input

Type: Serial Receive

GPIO Port:	2
Auxiliary:	Receive
Description:	<p>This function accepts data in the ANPP format as specified in 11 Advanced Navigation Packet Protocol.</p> <p>When this function is enabled, the GPIO and auxiliary ports function the same as the primary port, with two exceptions:</p> <ul style="list-style-type: none">• The GPIO and auxiliary ports cannot perform a firmware update.• When setting the ANPP packet and message output rates, the changes only apply to the port you are connected to. For example, you cannot change the primary port or GPIO port packet and message rates when connected to the auxiliary port.

10.6.1.32 RTCM Differential GNSS Corrections Input

Type:	Serial Receive
GPIO Port:	2
Auxiliary:	Receive
Description:	This function accepts RTCM v3 GNSS corrections messages. This allows for Differential GNSS or RTK with the Boreas internal GNSS receiver.

10.6.1.33 Trimble GNSS Input

Type:	Serial Receive
GPIO Port:	2
Auxiliary:	Receive
Description:	This function is designed for interfacing Boreas with an external Trimble GNSS receiver. It accepts data in the Trimble binary format GSOF and expects packet 0x40 with records 1, 2, 8, and 12 at rates higher than 1Hz (20 Hz recommended) and optional records 9 and 34 at 1 to 2 Hz.

10.6.1.34 u-blox GNSS Input

Type:	Serial Receive
GPIO Port:	2
Auxiliary:	Receive
Description:	This function is designed for interfacing Boreas with an external u-blox GNSS receiver. It accepts data in the u-blox binary format and expects message NAV-PVT at rates higher than 1 Hz.

10.6.1.35 Hemisphere GNSS Input

Type:	Serial Receive
GPIO Port:	2
Auxiliary:	Receive

Description: This function is designed for interfacing Boreas with an external Hemisphere GNSS receiver. It accepts data in the Hemisphere binary format and expects message Bin1 at rates higher than 1 Hz. For Hemisphere receivers that provide heading using two antennas, NMEA should be used instead as the binary format does not allow for transmission of heading information.

10.6.1.36 Teledyne DVL Input

Type: Serial Receive
GPIO Port: 2
Auxiliary: Receive
Description: This function accepts DVL data from a Teledyne DVL. For assistance with configuration, contact support@advancednavigation.com.

10.6.1.37 Tritech USBL Input

Type: Serial Receive
GPIO Port: 2
Auxiliary: Receive
Description: This function accepts USBL data from a Tritech USBL. For assistance with configuration, contact support@advancednavigation.com.

10.6.1.38 Linkquest DVL Input

Type: Serial Receive
GPIO Port: 2
Auxiliary: Receive
Description: This function accepts DVL data from a Linkquest DVL. For assistance with configuration, contact support@advancednavigation.com.

10.6.1.39 Linkquest USBL Input

Type: Serial Receive
GPIO Port: 2
Auxiliary: Receive
Description: This function accepts USBL data from a Linkquest USBL. For assistance with configuration, contact support@advancednavigation.com.

10.6.1.40 Nortek DVL Input

Type: Serial Receive
GPIO Port: 2
Auxiliary: Receive
Description: This function accepts DVL data in the Nortek DVL binary format. It accepts the packets

0x1B (DVL Bottom Track) and 0x1D (DVL Water Track). The recommended update rate is 8 Hz.

10.6.1.41 NMEA Output

Type:	Serial Transmit
GPIO Port:	1
Auxiliary:	Transmit
Description:	This function outputs a configurable combination of the NMEA messages GPZDA, GPGGA, GPVTG, GPRMC, GPHDT, PASHR, GPROT, GPHEV, GPGSV, PFECGPAtt, and PFECGPHve at up to 50 Hz. The messages output and the output rate can be configured using the web UI or Boreas Manager. An example output is shown below.

```
$GPZDA,031644.460,07,05,2013,00,00*52
$GPGGA,031644.460,3352.3501851,S,15112.2355488,E,6,00,1.4,150.0,M,0.0,M,,*7E
$GPVTG,089.19,T,089.19,M,000.00,N,000.00,K,E*27
$GPRMC,031644.460,A,3352.3501851,S,15112.2355488,E,0.0,89.2,070513,12.5,W,E*02
$GPHDT,89.2,T*06
$PASHR,031644.460,089.19,T,-00.01,-00.47,-00.00,,,,,0,0*2E
```

10.6.1.42 ANPP Output

Type:	Serial Transmit
GPIO Port:	1
Auxiliary:	Transmit
Description:	This function outputs data in the ANPP format as specified in 11 Advanced Navigation Packet Protocol . This function is for ANPP peripheral devices only. When this function is enabled, the GPIO and auxiliary ports function the same as the primary port, with two exceptions: <ul style="list-style-type: none"> • The GPIO and auxiliary ports cannot perform a firmware update. • When setting the ANPP packet and message output rates, the changes only apply to the port you are connected to. For example, you cannot change the primary port or GPIO port packet and message rates when connected to the auxiliary port.

10.6.1.43 TSS1 Output

Type:	Serial Transmit
GPIO Port:	1
Auxiliary:	Transmit
Description:	This function outputs the TSS1 format at a user configurable rate of up to 50 Hz. The

output rate can be configured using the page in the web UI.

10.6.1.44 Simrad 1000 Output

Type: Serial Transmit

GPIO Port: 1

Auxiliary: Transmit

Description: This function outputs the Simrad 1000 format at a user configurable rate of up to 50 Hz. The output rate can be configured using the [9.1.3.5 GPIO](#) page in the web UI or the [9.2.7.10 GPIO Output](#) dialogue in the Boreas Manager.

10.6.1.45 Simrad 3000 Output

Type: Serial Transmit

GPIO Port: 1

Auxiliary: Transmit

Description: This function outputs the Simrad 3000 format at a user configurable rate up to 50 Hz. The output rate can be configured using the [9.1.3.5 GPIO](#) page in the web UI or the [9.2.7.10 GPIO Output](#) dialogue in the Boreas Manager.

10.6.1.46 Serial Port Passthrough

Type: Serial

GPIO Port: 1, 2

Auxiliary: All

Description: This function allows passthrough communication through either GPIO 1 and 2 or the Auxiliary port. To transmit data use the [11.3.7 Serial Port Passthrough Packet](#). When data is received it will be sent back using the same [11.3.7 Serial Port Passthrough Packet](#).

10.6.1.47 GNSS Receiver Passthrough

Type: Serial

GPIO Port: 1, 2

Auxiliary: All

Description: This function allows for pass through connection to the internal GNSS receiver. This is useful for firmware updates of the internal GNSS receiver.

11 Advanced Navigation Packet Protocol

The Advanced Navigation Packet Protocol (ANPP) is a binary protocol designed with high error checking, high efficiency and safe design practices. It has a well defined specification and is very flexible. ANPP is proprietary and is used across all Advanced Navigation products. A packet type can be identified by its unique Packet ID. For more information about packets, see [11.1 About Packets](#).

The following packet types are available:

- [11.3 System Packets](#) - These packets have ID values of less than 20.
- [11.4 State Packets](#) - These packets have ID values between 20 and 179.
- [11.5 Configuration Packets](#) - These packets have IDs greater than 179.

The following table lists Advanced Navigation packets by type.

Packet ID	Name	Length	R/W
System Packets			
0	11.3.1 Acknowledge Packet	4	R
1	11.3.2 Request Packet	Varies	W
2	11.3.3 Boot Mode Packet	1	R/W
3	11.3.4 Device Information Packet	24	R
4	11.3.5 Restore Factory Settings Packet	4	W
5	11.3.6 Reset Packet	4	W
10	11.3.7 Serial Port Passthrough Packet	Varies	R/W
11	11.3.8 IP Configuration Packet	30	R/W
State Packets			
20	11.4.1 System State Packet	100	R
21	11.4.2 Unix Time Packet	8	R
22	11.4.3 Formatted Time Packet	14	R
23	11.4.4 Status Packet	4	R
24	11.4.5 Position Standard Deviation Packet	12	R
25	11.4.6 Velocity Standard Deviation Packet	12	R
26	11.4.7 Euler Orientation Standard Deviation Packet	12	R
27	11.4.8 Quaternion Orientation Standard Deviation Packet	16	R
28	11.4.9 Raw Sensors Packet	48	R
29	11.4.10 Raw GNSS Packet	74	R/W
30	11.4.11 Satellites Packet	13	R
32	11.4.12 Geodetic Position Packet	24	R
33	11.4.13 ECEF Position Packet	24	R

Packet ID	Name	Length	R/W
34	11.4.14 UTM Position Packet	26	R
35	11.4.15 NED Velocity Packet	12	R
36	11.4.16 Body Velocity Packet	12	R
37	11.4.17 Acceleration Packet	12	R
38	11.4.18 Body Acceleration Packet	16	R
39	11.4.19 Euler Orientation Packet	12	R
40	11.4.20 Quaternion Orientation Packet	16	R
41	11.4.21 DCM Orientation Packet	36	R
42	11.4.22 Angular Velocity Packet	12	R
43	11.4.23 Angular Acceleration Packet	12	R
44	11.4.24 External Position and Velocity Packet	60	R/W
45	11.4.25 External Position Packet	36	R/W
46	11.4.26 External Velocity Packet	24	R/W
47	11.4.27 External Body Velocity Packet	16 or 24	R/W
48	11.4.28 External Heading Packet	8	R/W
49	11.4.29 Running Time Packet	8	R
51	11.4.30 Odometer State Packet	20	R
52	11.4.31 External Time Packet	8	W
53	11.4.32 External Depth Packet	8	R/W
54	11.4.33 Geoid Height Packet	4	R
57	11.4.34 Wind Packet	12	R/W
58	11.4.35 Heave Packet	16	R
67	11.4.36 External Odometer Packet	13	W
68	11.4.37 External Air Data Packet	25	R/W
70	11.4.38 Raw DVL Data Packet	60	R/W
71	11.4.39 North Seeking Initialisation Status Packet	28	R
72	11.4.40 Gimbal State Packet	8	R/W
73	11.4.41 Automotive Packet	24	R
80	11.4.42 Basestation Packet	45	R
83	11.4.43 Zero Angular Velocity Packet	8	W
86	11.4.45 System Temperature Packet	64	R
89	11.4.44 Vessel Motion Packet	48	R

Packet ID	Name	Length	R/W
Configuration Packets			
180	11.5.1 Packet Timer Period Packet	4	R/W
181	11.5.2 Packets Period Packet	Varies	R/W
182	11.5.3 Baud Rates Packet	17	R/W
185	11.5.4 Installation Alignment Packet	73	R/W
186	11.5.5 Filter Options Packet	17	R/W
188	11.5.6 GPIO Configuration Packet	13	R/W
192	11.5.7 Odometer Configuration Packet	8	R/W
193	11.5.8 Set Zero Orientation Alignment Packet	5	W
194	11.5.9 Reference Point Offsets Packet	49	R/W
195	11.5.10 GPIO Output Configuration Packet	183	R/W
198	11.5.11 User Data Packet	64	R/W
199	11.5.12 GPIO Input Configuration Packet	65	R/W
203	11.5.13 CAN Configuration Packet	30	R/W

Table 37: Advanced Navigation Packets

11.1 About Packets

11.1.1 Packet Structure

The ANPP packet structure and the header format are shown in the tables below. Example source code is provided in multiple languages via the SDK, available from the [Boreas](#) product page of the Advanced Navigation website.

Header				
Header LRC	Packet ID	Packet Length	CRC16	Packet Data

Table 38: ANPP Packet Structure

Field #	Bytes Offset	Data Type	Size	Description
1	0	u8	1	Header LRC
2	1	u8	1	Packet ID
3	2	u8	1	Packet Length
4	3	u16	2	CRC

Table 39: ANPP Header Format

11.1.1.1 Header LRC

The header LRC (Longitudinal Redundancy Check) provides error checking on the packet header. It also allows the decoder to find the start of a packet by scanning for a valid LRC. Only the lower 8 bits of the calculation below are provided in the LRC field of the packet header. The LRC can be found using the following:

$$LRC = (PacketID + PacketLength + crc_0 + crc_1) \oplus 0xFF + 1$$

11.1.1.2 Packet ID

The packet ID is used to distinguish the contents of the packet. Packet IDs range from 0 to 255. See [11 Advanced Navigation Packet Protocol](#).

System packets have packet IDs in the range 0 to 19. These packets are implemented the same by every device using ANPP.

State packets are packets that contain data that changes with time, i.e. temperature. State packets can be set to output at a certain rate. State packets are packet IDs in the range 20 to 179.

Configuration packets are used for reading and writing device configuration. Configuration packets are packet IDs in the range 180 to 255.

11.1.1.3 Packet Length

The packet length denotes the length of the packet data, i.e. from byte index 5 onwards inclusive. Packet length has a range of 0 – 255.

11.1.1.4 CRC

The CRC is a CRC16-CCITT. The starting value is 0xFFFF. The CRC covers only the packet data.

11.1.2 Packet Requests

Any of the state and configuration packets can be requested at any time using the [11.3.2 Request Packet](#).

11.1.3 Packet Acknowledgement

When configuration packets are sent to Boreas, it will reply with an acknowledgement packet that indicates whether the configuration change was successful or not. See [11.3.1 Acknowledge Packet](#).

External data packets will also generate negative acknowledgement packets if there is a problem with the packet. Positive acknowledgements will not be sent. See [10.5 External Data](#) for a list of External Data Packets.

11.1.4 Packet Rates

The packet rates can be configured either using the web UI, or Boreas Manager or through the [11.5.2 Packets Period Packet](#). By default Boreas is configured to output the [11.4.1 System State Packet](#) at 20 Hz and the [11.4.9 Raw Sensors Packet](#) at 20 Hz. When configuring packet rates it is essential to ensure the baud rate is capable of handling the data throughput. This can be calculated using the rate and packet size. The packet size is calculated by adding the packet overhead to the packet length; the packet overhead is a fixed value of 5. For example to output the system state packet at 50Hz the calculation would be:

Data throughput = (100 (packet length) + 5 (fixed packet overhead)) * 50 (rate)

Data throughput = 5250 bytes per second

Minimum baud rate = data throughput x 11 = 57750 Baud

Closest standard baud rate = 115200 Baud

When multiple packets are set to output at the same rate, the order the packets output is from lowest ID to highest ID.

11.1.5 Packet Timing

Packets are output in order of packet ID from lowest ID to highest ID and all packets that are output in one sequence have their data matched to the same time of validity. The time of validity can be found in either the [11.4.1 System State Packet](#), the [11.4.2 Unix Time Packet](#) or the [11.4.3 Formatted Time Packet](#). For example if the [11.4.2 Unix Time Packet](#), [11.4.4 Status Packet](#) and [11.4.15 NED Velocity Packet](#) packet

were all set to output at 10 Hz, at each 0.1 second period the three packets would output consecutively by order of packet ID with all data synchronised between them and the [11.4.2 Unix Time Packet](#) providing the time of validity for the other two packets.

11.2 Data Types

The following data types are used in the packet protocol. All data types in the protocol are little endian byte ordering.

Abbreviation	Bytes	Also known as
u8	1	unsigned char, unsigned byte, uint8_t
s8	1	char, byte, int8_t
u16	2	unsigned short, uint16_t
s16	2	short, int16_t
u32	4	unsigned int, unsigned long, uint32_t
s32	4	int, long, int32_t
u64	8	unsigned long long, uint64_t
s64	8	long long, int64_t
fp32	4	float
fp64	8	double

Table 40: Data Type Abbreviations used in the ANPP

11.3 System Packets

11.3.1 Acknowledge Packet

Acknowledgement Packet				
Packet ID		0		
Length		4		
Read / Write		Read		
Field #	Bytes Offset	Data Type	Size	Description
1	0	u8	1	Packet ID being acknowledged
2	1	u16	2	CRC of packet being acknowledged
3	3	u8	1	11.3.1.1 Acknowledge Result

Table 41: Acknowledge Packet

11.3.1.1 Acknowledge Result

Value	Description
0	Acknowledge success
1	Acknowledge failure, CRC error
2	Acknowledge failure, packet size incorrect
3	Acknowledge failure, values outside of valid ranges
4	Acknowledge failure, system flash memory failure
5	Acknowledge failure, system not ready
6	Acknowledge failure, unknown packet

Table 42: Acknowledge Result

11.3.2 Request Packet

Request Packet				
Packet ID		1		
Length		1 x number of packets requested		
Read / Write		Write		
Field #	Bytes Offset	Data Type	Size	Description
1	0	u8	1	Packet ID requested
+				Field 1 repeats for additional packet requests

Table 43: Request Packet

11.3.3 Boot Mode Packet

Boot Mode Packet				
Packet ID		2		
Length		1		
Read / Write		Read / Write		
Field #	Bytes Offset	Data Type	Size	Description
1	0	u8	1	11.3.3.1 Boot Mode Types

Table 44: Boot Mode Packet

11.3.3.1 Boot Mode Types

Value	Description
0	Bootloader
1	Main Program

Table 45: Boot Mode Types

11.3.4 Device Information Packet

Device Information Packet				
Packet ID		3		
Length		24		
Read / Write		Read		
Field #	Bytes Offset	Data Type	Size	Description
1	0	u32	4	Software version
2	4	u32	4	11.3.4.1 Device ID
3	8	u32	4	Hardware revision
4	12	u32	4	Boreas Serial number part 1
5	16	u32	4	Boreas Serial number part 2
6	20	u32	4	Boreas Serial number part 3

Table 46: Device Information Packet

11.3.4.1 Device ID

Value	Description
1	Spatial
4	Spatial FOG
5	Spatial Dual
11	Orientus (>v3)
13	Air Data Unit
14	Subsonus
16	Spatial FOG Dual
17	Motus
19	GNSS Compass
21	Subsonus Tag
22	Poseidon
26	Certus
27	Aries
28	Boreas D90
41	Boreas D70

Table 47: Device IDs

11.3.5 Restore Factory Settings Packet

Note: A Factory Reset will re-enable the DHCP Client and lose any static IP address settings.

Restore Factory Settings Packet				
Packet ID		4		
Length		4		
Read / Write		Write		
Field #	Bytes Offset	Data Type	Size	Description
1	0	u32	4	Verification sequence (set to 0x85429E1C)

Table 48: Restore Factory Settings Packet

11.3.6 Reset Packet

Reset Packet				
Packet ID		5		
Length		4		
Read / Write		Write		
Field #	Bytes Offset	Data Type	Size	Description
1	0	u32	4	11.3.6.1 Verification Sequence Values

Table 49: Reset Packet

11.3.6.1 Verification Sequence Values

Value	Description
0x21057A7E	Standard hot start reset
0x9A5D38B7	Cold start reset

Table 50: Verification Sequence Values

11.3.7 Serial Port Passthrough Packet

Serial Port Passthrough Packet				
Packet ID		10		
Length		Variable, up to 255 bytes		
Read / Write		Read / Write		
Field #	Bytes Offset	Data Type	Size	Description
1	0	u8	1	Passthrough Route
2	1			Passthrough Data

Table 51: Serial Port Passthrough Packet

11.3.7.1 Passthrough Route

Value	Description
1	GPIO 1 and 2
2	Auxiliary

Table 52: Passthrough Route

11.3.8 IP Configuration Packet

IP Configuration Packet				
Packet ID		11		
Length		30		
Read / Write		Read / Write		
Field #	Bytes Offset	Data Type	Size	Description
1	0	u8	1	Permanent
2	1	u8	1	11.3.8.1 DHCP Mode
3	2	u32	4	IP Address
4	6	u32	4	IP Netmask
5	10	u32	4	IP Gateway
6	14	u32	4	DNS Server
7	18	u32	4	Boreas Serial number part 1
8	22	u32	4	Boreas Serial number part 2
9	26	u32	4	Boreas Serial number part 3

Table 53: IP Configuration Packet

11.3.8.1 DHCP Mode

Bit	Description
0	DHCP Enabled
1	Automatic DNS
2-4	Link Mode. See 11.3.8.2 Link Mode Index
5-7	Reserved (set to zero)

Table 54: DHCP Mode

11.3.8.2 Link Mode Index

Value	Bit 4	Bit 3	Bit 2	Description
0	0	0	0	Auto

Table 55: Link Mode Index

11.3.8.3 Discovery Network Setting Overwrite

Settings 7,8 and 9 are optional over standard network interfaces but required to overwrite settings over multi-cast discovery. To overwrite network settings for a device over multi-cast send this packet to address 239.48.81.7 port 48817, the serial number must be set to the serial number of the device you want to overwrite settings for.

11.4 State Packets

Boreas supports a ANPP number of packets providing extensive functionality. However for the majority of users the easiest approach is to configure Boreas using the web UI or Boreas Manager software and then support only the single system state packet shown in [11.4.1 System State Packet](#). Advanced functionality can be added as required through the other packets.

This section covers the following topics:

Packet ID	Name	Length	R/W
State Packets			
20	11.4.1 System State Packet	100	R
21	11.4.2 Unix Time Packet	8	R
22	11.4.3 Formatted Time Packet	14	R
23	11.4.4 Status Packet	4	R
24	11.4.5 Position Standard Deviation Packet	12	R
25	11.4.6 Velocity Standard Deviation Packet	12	R
26	11.4.7 Euler Orientation Standard Deviation Packet	12	R
27	11.4.8 Quaternion Orientation Standard Deviation Packet	16	R
28	11.4.9 Raw Sensors Packet	48	R
29	11.4.10 Raw GNSS Packet	74	R/W
30	11.4.11 Satellites Packet	13	R
32	11.4.12 Geodetic Position Packet	24	R
33	11.4.13 ECEF Position Packet	24	R
34	11.4.14 UTM Position Packet	26	R
35	11.4.15 NED Velocity Packet	12	R
36	11.4.16 Body Velocity Packet	12	R
37	11.4.17 Acceleration Packet	12	R
38	11.4.18 Body Acceleration Packet	16	R
39	11.4.19 Euler Orientation Packet	12	R
40	11.4.20 Quaternion Orientation Packet	16	R
41	11.4.21 DCM Orientation Packet	36	R
42	11.4.22 Angular Velocity Packet	12	R
43	11.4.23 Angular Acceleration Packet	12	R
44	11.4.24 External Position and Velocity Packet	60	R/W
45	11.4.25 External Position Packet	36	R/W
46	11.4.26 External Velocity Packet	24	R/W

Packet ID	Name	Length	R/W
47	11.4.27 External Body Velocity Packet	16 or 24	R/W
48	11.4.28 External Heading Packet	8	R/W
49	11.4.29 Running Time Packet	8	R
51	11.4.30 Odometer State Packet	20	R
52	11.4.31 External Time Packet	8	W
53	11.4.32 External Depth Packet	8	R/W
54	11.4.33 Geoid Height Packet	4	R
57	11.4.34 Wind Packet	12	R/W
58	11.4.35 Heave Packet	16	R
67	11.4.36 External Odometer Packet	13	W
68	11.4.37 External Air Data Packet	25	R/W
70	11.4.38 Raw DVL Data Packet	60	R/W
71	11.4.39 North Seeking Initialisation Status Packet	28	R
72	11.4.40 Gimbal State Packet	8	R/W
73	11.4.41 Automotive Packet	24	R
80	11.4.42 Basestation Packet	45	R
83	11.4.43 Zero Angular Velocity Packet	8	W
86	11.4.45 System Temperature Packet	64	R
89	11.4.44 Vessel Motion Packet	48	R

Table 56: State Packets

11.4.1 System State Packet

System State Packet				
Packet ID				20
Length				100
Read / Write				Read
Field #	Bytes Offset	Data Type	Size	Description
1	0	u16	2	11.4.1.1 System Status
2	2	u16	2	11.4.1.2 Filter Status
3	4	u32	4	11.4.1.4 Unix Time Seconds
4	8	u32	4	11.4.1.5 Microseconds
5	12	fp64	8	Latitude (rad)
6	20	fp64	8	Longitude (rad)
7	28	fp64	8	Height (m)
8	36	fp32	4	Velocity north (m/s)
9	40	fp32	4	Velocity east (m/s)
10	44	fp32	4	Velocity down (m/s)
11	48	fp32	4	Body acceleration X (m/s/s)
12	52	fp32	4	Body acceleration Y (m/s/s)
13	56	fp32	4	Body acceleration Z (m/s/s)
14	60	fp32	4	G force (g)
15	64	fp32	4	Roll (radians)
16	68	fp32	4	Pitch (radians)
17	72	fp32	4	Heading (radians)
18	76	fp32	4	Angular velocity X (rad/s)
19	80	fp32	4	Angular velocity Y (rad/s)
20	84	fp32	4	Angular velocity Z (rad/s)
21	88	fp32	4	Latitude standard deviation (m)
22	92	fp32	4	Longitude standard deviation (m)
23	96	fp32	4	Height standard deviation (m)

Table 57: System State Packet

11.4.1.1 System Status

This field contains 16 bits that indicate problems with the system. These are boolean fields with a zero indicating false and one indicating true.

Bit	Description
0	System Failure
1	Accelerometer Sensor Failure
2	Gyroscope Sensor Failure
3	Reserved
4	Pressure Sensor Failure
5	Reserved (set to zero)
6	Accelerometer Over Range
7	Gyroscope Over Range
8	Reserved
9	Pressure Over Range
10	Minimum Temperature Alarm
11	Maximum Temperature Alarm
12	Internal Data Logging Error
13	High Voltage Alarm
14	Reserved (set to zero)
15	Data Output Overflow Alarm

Table 58: System Status

11.4.1.2 Filter Status

This field contains 16 bits that indicate the status of the filters. These are boolean fields with a zero indicating false and one indicating true.

Bit	Description
0	Orientation Filter Initialised
1	Navigation Filter Initialised
2	Heading Initialised
3	UTC Time Initialised
4	11.4.1.3 GNSS Fix Status
5	
6	
7	Event 1 Occurred
8	Event 2 Occurred
9	Internal GNSS Enabled
10	Heading Active
11	Velocity Heading Enabled
12	Atmospheric Altitude Enabled
13	External Position Active
14	External Velocity Active
15	External Heading Active

Table 59: Filter Status

11.4.1.3 GNSS Fix Status

Value	Bit 6	Bit 5	Bit 4	Description
0	0	0	0	No GNSS fix
1	0	0	1	2D GNSS fix
2	0	1	0	3D GNSS fix
3	0	1	1	SBAS GNSS fix
4	1	0	0	Differential GNSS fix
5	1	0	1	PPP GNSS fix
6	1	1	0	RTK Float GNSS fix
7	1	1	1	RTK Fixed GNSS fix

Table 60: GNSS Fix Status

11.4.1.4 Unix Time Seconds

This field provides the Unix time in seconds, using the standard epoch of January 1, 1970.

11.4.1.5 Microseconds

This field provides the sub-second component of time. It is represented as microseconds since the last second. Minimum value is 0 and maximum value is 999999.

11.4.2 Unix Time Packet

Unix Time Packet				
Packet ID				21
Length				8
Read / Write				Read
Field #	Bytes Offset	Data Type	Size	Description
1	0	u32	4	Unix time stamp (seconds). See 11.4.1.4 Unix Time Seconds
2	4	u32	4	Microseconds

Table 61: Unix Time Packet

11.4.3 Formatted Time Packet

Formatted Time Packet				
Packet ID				22
Length				14
Read / Write				Read
Field #	Bytes Offset	Data Type	Size	Description
1	0	u32	4	Microseconds
2	4	u16	2	Year
3	6	u16	2	Year day, 0 - 365
4	8	u8	1	Month, 0 - 11
5	9	u8	1	Month Day, 1 - 31
6	10	u8	1	Week Day, 0 – 6 (0 = Sunday)
7	11	u8	1	Hour, 0 - 23
8	12	u8	1	Minute, 0 - 59
9	13	u8	1	Second, 0 - 59

Table 62: Formatted Time Packet

11.4.4 Status Packet

Status Packet				
Packet ID				23
Length				4
Read / Write				Read
Field #	Bytes Offset	Data Type	Size	Description
1	0	u16	2	System Status
2	2	u16	2	Filter Status

Table 63: Status Packet

11.4.5 Position Standard Deviation Packet

Position Standard Deviation Packet				
Packet ID				24
Length				12
Read / Write				Read
Field #	Bytes Offset	Data Type	Size	Description
1	0	fp32	4	Latitude standard deviation (m)
2	4	fp32	4	Longitude standard deviation (m)
3	8	fp32	4	Height standard deviation (m)

Table 64: Position Standard Deviation Packet

11.4.6 Velocity Standard Deviation Packet

Velocity Standard Deviation Packet				
Packet ID				25
Length				12
Read / Write				Read
Field #	Bytes Offset	Data Type	Size	Description
1	0	fp32	4	Velocity north standard deviation (m/s)
2	4	fp32	4	Velocity east standard deviation (m/s)
3	8	fp32	4	Velocity down standard deviation (m/s)

Table 65: Velocity Standard Deviation Packet

11.4.7 Euler Orientation Standard Deviation Packet

Euler Orientation Standard Deviation Packet				
Packet ID				26
Length				12
Read / Write				Read
Field #	Bytes Offset	Data Type	Size	Description
1	0	fp32	4	Roll standard deviation (rad)
2	4	fp32	4	Pitch standard deviation(rad)
3	8	fp32	4	Heading standard deviation(rad)

Table 66: Euler Orientation Standard Deviation Packet

11.4.8 Quaternion Orientation Standard Deviation Packet

Quaternion Orientation Standard Deviation Packet				
Packet ID				27
Length				16
Read / Write				Read
Field #	Bytes Offset	Data Type	Size	Description
1	0	fp32	4	Q0 standard deviation
2	4	fp32	4	Q1 standard deviation
3	8	fp32	4	Q2 standard deviation
4	12	fp32	4	Q3 standard deviation

Table 67: Quaternion Orientation Standard Deviation Packet

11.4.9 Raw Sensors Packet

Raw Sensors Packet				
Packet ID				28
Length				48
Read / Write				Read
Field #	Bytes Offset	Data Type	Size	Description
1	0	fp32	4	Accelerometer X (m/s/s)
2	4	fp32	4	Accelerometer Y (m/s/s)
3	8	fp32	4	Accelerometer Z (m/s/s)
4	12	fp32	4	Gyroscope X (rad/s)
5	16	fp32	4	Gyroscope Y (rad/s)
6	20	fp32	4	Gyroscope Z (rad/s)
7	24	fp32	4	Reserved
8	28	fp32	4	Reserved
9	32	fp32	4	Reserved
10	36	fp32	4	IMU Temperature (deg C)
11	40	fp32	4	Pressure (Pascals)
12	44	fp32	4	Pressure Temperature (deg C)

Table 68: Raw Sensors Packet

11.4.10 Raw GNSS Packet

This packet represents the raw data as it is received from the GNSS receiver. The position is not corrected for antenna position offset and the velocity is not compensated for the antenna lever arm offset. The INS position and velocity that are in the other packets are corrected for antenna position offset and lever arm.

Note: Raw GNSS is only available if the Boreas A90 or A70 has a license upgrade to full INS capability, and is interfaced to an external GNSS receiver.

Raw GNSS Packet				
Packet ID		29		
Length		74		
Read / Write		Read		
Field #	Bytes Offset	Data Type	Size	Description
1	0	u32	4	Unix time stamp (seconds)
2	4	u32	4	Microseconds
3	8	fp64	8	Latitude (rad)
4	16	fp64	8	Longitude (rad)
5	24	fp64	8	Height (m)
6	32	fp32	4	Velocity north (m/s)
7	36	fp32	4	Velocity east (m/s)
8	40	fp32	4	Velocity down (m/s)
9	44	fp32	4	Latitude standard deviation (m)
10	48	fp32	4	Longitude standard deviation (m)
11	52	fp32	4	Height standard deviation (m)
12	56	fp32	4	Tilt (rad)
13	60	fp32	4	Heading (rad)
14	64	fp32	4	Tilt standard deviation (rad)
15	68	fp32	4	Heading standard deviation (rad)
16	72	u16	2	Status. See 11.4.10.1 Raw GNSS Status

Table 69: Raw GNSS Packet

11.4.10.1 Raw GNSS Status

Bit	Description
0	GNSS Fix Status
1	
2	
3	Doppler velocity valid

Bit	Description
4	Time valid
5	External GNSS
6	Tilt valid
7	Heading valid
8	Floating ambiguity heading
9-15	Reserved (set to zero)

Table 70: Raw GNSS Status

11.4.11 Satellites Packet

Satellites Packet				
Packet ID				30
Length				13
Read / Write				Read
Field #	Bytes Offset	Data Type	Size	Description
1	0	fp32	4	HDOP
2	4	fp32	4	VDOP
3	8	u8	1	GPS satellites
4	9	u8	1	GLONASS satellites
5	10	u8	1	BeiDou satellites
6	11	u8	1	GALILEO satellites
7	12	u8	1	SBAS satellites

Table 71: Satellites Packet

11.4.12 Geodetic Position Packet

Geodetic Position Packet				
Packet ID				32
Length				24
Read / Write				Read
Field #	Bytes Offset	Data Type	Size	Description
1	0	fp64	8	Latitude (rad)
2	8	fp64	8	Longitude (rad)
3	16	fp64	8	Height (m)

Table 72: Geodetic Position Packet

11.4.13 ECEF Position Packet

ECEF Position Packet				
Packet ID				33
Length				24
Read / Write				Read
Field #	Bytes Offset	Data Type	Size	Description
1	0	fp64	8	ECEF X (m)
2	8	fp64	8	ECEF Y (m)
3	16	fp64	8	ECEF Z (m)

Table 73: ECEF Position Packet

11.4.14 UTM Position Packet

UTM Position Packet				
Packet ID				34
Length				26
Read / Write				Read
Field #	Bytes Offset	Data Type	Size	Description
1	0	fp64	8	Northing (m)
2	8	fp64	8	Easting (m)
3	16	fp64	8	Height (m)
4	24	u8	1	Zone number
5	25	s8	1	Zone character

Table 74: UTM Position Packet

11.4.15 NED Velocity Packet

NED Velocity Packet				
Packet ID		35		
Length		12		
Read / Write		Read		
Field #	Bytes Offset	Data Type	Size	Description
1	0	fp32	4	Velocity north (m/s)
2	4	fp32	4	Velocity east (m/s)
3	8	fp32	4	Velocity down (m/s)

Table 75: NED Velocity Packet

11.4.16 Body Velocity Packet

Body Velocity Packet				
Packet ID		36		
Length		12		
Read / Write		Read		
Field #	Bytes Offset	Data Type	Size	Description
1	0	fp32	4	Velocity X (m/s)
2	4	fp32	4	Velocity Y (m/s)
3	8	fp32	4	Velocity Z (m/s)

Table 76: Body Velocity Packet

11.4.17 Acceleration Packet

This packet includes the acceleration due to gravity.

Acceleration Packet				
Packet ID		37		
Length		12		
Read / Write		Read		
Field #	Bytes Offset	Data Type	Size	Description
1	0	fp32	4	Acceleration X (m/s/s)
2	4	fp32	4	Acceleration Y (m/s/s)
3	8	fp32	4	Acceleration Z (m/s/s)

Table 77: Acceleration Packet

11.4.18 Body Acceleration Packet

This packet does not include the acceleration due to gravity.

Body Acceleration Packet				
Packet ID		38		
Length		16		
Read / Write		Read		
Field #	Bytes Offset	Data Type	Size	Description
1	0	fp32	4	Body acceleration X (m/s/s)
2	4	fp32	4	Body acceleration Y (m/s/s)
3	8	fp32	4	Body acceleration Z (m/s/s)
4	12	fp32	4	G force (g)

Table 78: Body Acceleration Packet

11.4.19 Euler Orientation Packet

Euler Orientation Packet				
Packet ID		39		
Length		12		
Read / Write		Read		
Field #	Bytes Offset	Data Type	Size	Description
1	0	fp32	4	Roll (rad)
2	4	fp32	4	Pitch (rad)
3	8	fp32	4	Heading (rad)

Table 79: Euler Orientation Packet

11.4.20 Quaternion Orientation Packet

Quaternion Orientation Packet				
Packet ID		40		
Length		16		
Read / Write		Read		
Field #	Bytes Offset	Data Type	Size	Description
1	0	fp32	4	QS
2	4	fp32	4	QX
3	8	fp32	4	QY
4	12	fp32	4	QZ

Table 80: Quaternion Orientation Packet

11.4.21 DCM Orientation Packet

DCM Orientation Packet				
Packet ID				41
Length				36
Read / Write				Read
Field #	Bytes Offset	Data Type	Size	Description
1	0	fp32	4	DCM[0][0]
2	4	fp32	4	DCM[0][1]
3	8	fp32	4	DCM[0][2]
4	12	fp32	4	DCM[1][0]
5	16	fp32	4	DCM[1][1]
6	20	fp32	4	DCM[1][2]
7	24	fp32	4	DCM[2][0]
8	28	fp32	4	DCM[2][1]
9	32	fp32	4	DCM[2][2]

Table 81: DCM Orientation Packet

11.4.22 Angular Velocity Packet

Angular Velocity Packet				
Packet ID				42
Length				12
Read / Write				Read
Field #	Bytes Offset	Data Type	Size	Description
1	0	fp32	4	Angular velocity X (rad/s)
2	4	fp32	4	Angular velocity Y (rad/s)
3	8	fp32	4	Angular velocity Z (rad/s)

Table 82: Angular Velocity Packet

11.4.23 Angular Acceleration Packet

Angular Acceleration Packet				
Packet ID				43
Length				12
Read / Write				Read
Field #	Bytes Offset	Data Type	Size	Description
1	0	fp32	4	Angular acceleration X (rad/s/s)
2	4	fp32	4	Angular acceleration Y (rad/s/s)
3	8	fp32	4	Angular acceleration Z (rad/s/s)

Table 83: Angular Acceleration Packet

11.4.24 External Position and Velocity Packet

External Position and Velocity Packet				
Packet ID				44
Length				60
Read / Write				Read / Write
Field #	Bytes Offset	Data Type	Size	Description
1	0	fp64	8	Latitude (rad)
2	8	fp64	8	Longitude (rad)
3	16	fp64	8	Height (m)
4	24	fp32	4	Velocity north (m/s)
5	28	fp32	4	Velocity east (m/s)
6	32	fp32	4	Velocity down (m/s)
7	36	fp32	4	Latitude standard deviation (m)
8	40	fp32	4	Longitude standard deviation (m)
9	44	fp32	4	Height standard deviation (m)
10	48	fp32	4	Velocity north standard deviation (m/s)
11	52	fp32	4	Velocity east standard deviation (m/s)
12	56	fp32	4	Velocity down standard deviation (m/s)

Table 84: External Position and Velocity Packet

11.4.25 External Position Packet

External Position Packet				
Packet ID				45
Length				36
Read / Write				Read / Write
Field #	Bytes Offset	Data Type	Size	Description
1	0	fp64	8	Latitude (rad)
2	8	fp64	8	Longitude (rad)
3	16	fp64	8	Height (m)
4	24	fp32	4	Latitude standard deviation (m) Must be non-zero positive value
5	28	fp32	4	Longitude standard deviation (m) Must be non-zero positive value
6	32	fp32	4	Height standard deviation (m) Must be non-zero positive value

Table 85: External Position Packet

11.4.26 External Velocity Packet

External Velocity Packet				
Packet ID				46
Length				24
Read / Write				Read / Write
Field #	Bytes Offset	Data Type	Size	Description
1	0	fp32	4	Velocity north (m/s)
2	4	fp32	4	Velocity east (m/s)
3	8	fp32	4	Velocity down (m/s)
4	12	fp32	4	Velocity north standard deviation (m/s)
5	16	fp32	4	Velocity east standard deviation (m/s)
6	20	fp32	4	Velocity down standard deviation (m/s)

Table 86: External Velocity Packet

11.4.27 External Body Velocity Packet

This packet has been defined to support a single velocity standard deviation for all three axes, or, different values for all three axes. Modify the packet length in the packet header accordingly, depending on which format you are using.

External Body Velocity Packet				
Packet ID		47		
Length		16 or 24		
Read / Write		Read / Write		
Field #	Bytes Offset	Data Type	Size	Description
1	0	fp32	4	Velocity X (m/s)
2	4	fp32	4	Velocity Y (m/s)
3	8	fp32	4	Velocity Z (m/s)
4	12	fp32	4	Velocity X standard deviation (m/s)
5	16	fp32	4	OPTIONAL: Velocity standard deviation Y (m/s)
6	20	fp32	4	OPTIONAL: Velocity standard deviation Z (m/s)

Table 87: External Body Velocity Packet

11.4.28 External Heading Packet

External Heading Packet				
Packet ID		48		
Length		8		
Read / Write		Read / Write		
Field #	Bytes Offset	Data Type	Size	Description
1	0	fp32	4	Heading (rad)
2	4	fp32	4	Heading standard deviation (rad)

Table 88: External Heading Packet

11.4.29 Running Time Packet

This packet provides the running time in seconds since the most recent power on.

Running Time Packet				
Packet ID		49		
Length		8		
Read / Write		Read		
Field #	Bytes Offset	Data Type	Size	Description
1	0	u32	4	Running time (seconds)
2	4	u32	4	11.4.1.5 Microseconds

Table 89: Running Time Packet

11.4.30 Odometer State Packet

Odometer State Packet				
Packet ID				51
Length				20
Read / Write				Read
Field #	Bytes Offset	Data Type	Size	Description
1	0	s32	4	Odometer pulse count
2	4	fp32	4	Odometer distance (m)
3	8	fp32	4	Odometer speed (m/s)
4	12	fp32	4	Odometer slip (m)
5	16	u8	1	Odometer active
6	17		3	Reserved

Table 90: Odometer State Packet

11.4.31 External Time Packet

External Time Packet				
Packet ID				52
Length				8
Read / Write				Write
Field #	Bytes Offset	Data Type	Size	Description
1	0	u32	4	11.4.1.4 Unix Time Seconds
2	4	u32	4	11.4.1.5 Microseconds

Table 91: External Time Packet

11.4.32 External Depth Packet

External Depth is the measured distance below Mean Sea Level

External Depth Packet				
Packet ID				53
Length				8
Read / Write				Read / Write
Field #	Bytes Offset	Data Type	Size	Description
1	0	fp32	4	Depth (m)
2	4	fp32	4	Depth standard deviation (m)

Table 92: External Depth Packet

11.4.33 Geoid Height Packet

This packet provides the offset at the current location between the WGS84 ellipsoid and the EGM96 geoid model. This can be used to determine the current height above mean sea level and also depth through the following equations:

Height Above Mean Sea Level = WGS84 Height – Geoid Height

Depth = Geoid Height – WGS84 Height

WGS84 Height is the height at the current location in the System State packet, see [11.4.1 System State Packet](#)

Geoid Height Packet				
Packet ID		54		
Length		4		
Read / Write		Read		
Field #	Bytes Offset	Data Type	Size	Description
1	0	fp32	4	Geoid height (m)

Table 93: Geoid Height Packet

11.4.34 Wind Packet

This packet provides the Boreas current 2D wind velocity. These values are only valid when external air data is provided to Boreas. This can be either through the [11.4.37 External Air Data Packet](#) or when a pitot tube is interfaced to one of the GPIO pins. When this packet is written to the device, it disables the wind estimation filter and the wind values provided are used statically.

Wind Packet				
Packet ID		57		
Length		12		
Read / Write		Read / Write		
Field #	Bytes Offset	Data Type	Size	Description
1	0	fp32	4	Wind velocity north (m/s)
2	4	fp32	4	Wind velocity east (m/s)
3	8	fp32	4	Wind velocity standard deviation (m/s)

Table 94: Wind Packet

11.4.35 Heave Packet

Note: For surge and sway values, see [11.4.44 Vessel Motion Packet](#).

Heave Packet	
Packet ID	58
Length	16
Read / Write	Read

Heave Packet				
Field #	Bytes Offset	Data Type	Size	Description
1	0	fp32	4	Heave point 1 (m)
2	4	fp32	4	Heave point 2 (m)
3	8	fp32	4	Heave point 3 (m)
4	12	fp32	4	Heave point 4 (m)

Table 95: Heave Packet

11.4.36 External Odometer Packet

External Odometer Packet				
Packet ID			67	
Length			13	
Read / Write			Write	
Field #	Bytes Offset	Data Type	Size	Description
1	0	fp32	4	Estimated delay (s)
2	4	fp32	4	Speed (m/s)
3	8	fp32	4	Reserved (set to zero)
4	12	u8	1	Odometer flags

Table 96: External Odometer Packet

11.4.36.1 Odometer Flags

Bit	Description
0	Reversing detection supported
1-7	Reserved (set to zero)

Table 97: Odometer Flags

11.4.37 External Air Data Packet

External Air Data Packet				
Packet ID		68		
Length		25		
Read / Write		Read / Write		
Field #	Bytes Offset	Data Type	Size	Description
1	0	fp32	4	Barometric altitude delay (s)
2	4	fp32	4	Airspeed delay (s)
2	8	fp32	4	Barometric altitude (m)
3	12	fp32	4	Airspeed (m/s)
4	16	fp32	4	Barometric altitude standard deviation (m)
5	20	fp32	4	Airspeed standard deviation (m/s)
6	24	u8	1	Flags

Table 98: External Air Data Packet

11.4.37.1 External Air Data Flags

Bit	Description
0	Barometric altitude set and valid
1	Airspeed set and valid
2	Barometric altitude reference reset

Table 99: External Air Data Flags

Barometric altitude does not need to be referenced to any co-ordinate frame or QNH. If the barometric altitude reference is changed during operation, the barometric altitude reference reset flag should be set for the next packet.

11.4.38 Raw DVL Data Packet

Raw DVL Data Packet				
Packet ID		70		
Length		60		
Read / Write		Read / Write		
Field #	Bytes Offset	Data Type	Size	Description
1	0	u32	4	Unix timestamp (seconds)
2	4	u32	4	Microseconds
3	8	u32	4	Flags, see 11.4.38.1 Raw DVL Data Flags
4	12	fp32	4	Bottom velocity X (m/s)
5	16	fp32	4	Bottom velocity Y (m/s)
6	20	fp32	4	Bottom velocity Z (m/s)
7	24	fp32	4	Bottom velocity standard deviation (m/s)
8	28	fp32	4	Water velocity X (m/s)
9	32	fp32	4	Water velocity Y (m/s)
10	36	fp32	4	Water velocity Z (m/s)
11	40	fp32	4	Water velocity standard deviation (m/s)
12	44	fp32	4	Water velocity layer depth (m)
13	48	fp32	4	Depth (m)
14	52	fp32	4	Altitude (m)
15	56	fp32	4	Temperature (deg C)

Table 100: Raw DVL Data Packet

11.4.38.1 Raw DVL Data Flags

Bit	Description
0	Bottom velocity valid
1	Water velocity valid
2	Temperature valid
3	Depth valid
4	Altitude valid

Table 101: Raw DVL Data Flags

11.4.39 North Seeking Initialisation Status Packet

North Seeking Initialisation Status Packet	
Packet ID	71
Length	28

North Seeking Initialisation Status Packet				
Read / Write				Read
Field #	Bytes Offset	Data Type	Size	Description
1	0	u16	2	Flags, See 11.4.39.1 North Seeking Initialisation Status Flags
2	2	u16	2	Version
3	4	u8	1	Progress (%)
4	5	u8	1	Alignment Attempts
5	6		2	Reserved (set to zero)
6	8	fp32	4	Coarse alignment heading (rad)
7	12	fp32	4	Predicted accuracy (rad)
8	16		12	Reserved (set to zero)

Table 102: North Seeking Initialisation Status Packet

11.4.39.1 North Seeking Initialisation Status Flags

Value	Description
0	North seeking initialisation complete
1	North seeking initialisation cannot start because the position is unknown
2	Solution out of range
3	Solution non-orthogonal
4	Restarted due to excessive movement
5	Restarted due to change in latitude
6	Restarted due to user change in lever arm offset
7	Latitude check failed
8-15	Reserved (set to zero)

Table 103: North Seeking Initialisation Status Flags

11.4.40 Gimbal State Packet

Boreas will accept (write) Current angle values between -2π and 2π exclusive.

Boreas will output (read) values between $-\pi$ and π for current angle.

Gimbal State Packet				
Packet ID				72
Length				8
Read / Write				Read / Write
Field #	Bytes Offset	Data Type	Size	Description
1	0	fp32	4	Current angle (rad)

Gimbal State Packet				
2	4		4	Reserved (set to zero)

Table 104: Gimbal State Packet

11.4.41 Automotive Packet

The value of the slip angle will be zero unless velocity is greater than 3.45 m/s and heading is valid.

Automotive Packet				
Packet ID			73	
Length			24	
Read / Write			Read	
Field #	Bytes Offset	Data Type	Size	Description
1	0	fp32	4	Virtual odometer distance (m)
2	4	fp32	4	Slip Angle (rad) Value reported is zero, unless heading is valid and the velocity is greater than 3.45 m/s
3	8	fp32	4	Velocity X (m/s)
4	12	fp32	4	Velocity Y (m/s)
5	16	fp32	4	Distance standard deviation (m)
6	20		4	Reserved (set to zero)

Table 105: Automotive Packet

11.4.42 Basestation Packet

Basestation Packet				
Packet ID			80	
Length			45	
Read / Write			Read	
Field #	Bytes Offset	Data Type	Size	Description
1	0	u32	4	11.4.1.4 Unix Time Seconds
2	4	u32	4	11.4.1.5 Microseconds
3	8	fp64	8	Basestation position, latitude (rad)
4	16	fp64	8	Basestation position, longitude (rad)
5	24	fp64	8	Basestation position, altitude (rad)
6	32	fp32	4	Basestation relative position, north (m)
7	36	fp32	4	Basestation relative position, east (m)
8	40	fp32	4	Basestation relative position, down (m)
9	44	u8	1	11.4.42.1 GNSS Fix Status

Table 106: Basestation packet

11.4.42.1 GNSS Fix Status

Value	Description
0	No GNSS fix
1	2D GNSS fix
2	3D GNSS fix
3	SBAS GNSS fix
4	Differential GNSS fix
5	Omnistar/Starfire GNSS fix
6	RTK Float GNSS fix
7	RTK Fixed GNSS fix

Table 107: GNSS Fix Status

11.4.43 Zero Angular Velocity Packet

Zero Angular Velocity Packet				
Packet ID				83
Length				8
Read / Write				Write
Field #	Bytes Offset	Data Type	Size	Description
1	0	fp32	4	Duration. See 11.4.43.1 Zero Angular Velocity Duration
2	4		4	Reserved (set to zero)

Table 108: Zero Angular Velocity Packet

11.4.43.1 Zero Angular Velocity Duration

Duration is the duration that the unit has been stationary for about the heading axis. The minimum value is 0.1 seconds and the maximum value is 2 seconds.

11.4.44 Vessel Motion Packet

Vessel Motion Packet				
Packet ID				89
Length				48
Read / Write				Read
Field #	Bytes Offset	Data Type	Size	Description
1	0	fp32	4	Surge Point 1 (m)
2	4	fp32	4	Surge Point 2 (m)
3	8	fp32	4	Surge Point 3 (m)
4	12	fp32	4	Surge Point 4 (m)

Vessel Motion Packet				
5	16	fp32	4	Sway Point 1 (m)
6	20	fp32	4	Sway Point 2 (m)
7	24	fp32	4	Sway Point 3 (m)
8	28	fp32	4	Sway Point 4 (m)
9	32	fp32	4	Heave Point 1 (m)
10	36	fp32	4	Heave Point 2 (m)
11	40	fp32	4	Heave Point 3 (m)
12	44	fp32	4	Heave Point 4 (m)

Table 109: Vessel Motion Packet

11.4.45 System Temperature Packet

Sensor Temperatures Packet				
Packet ID		86		
Length		64		
Read / Write		Read		
Field #	Bytes Offset	Data Type	Size	Description
1	0	fp32	4	System Temperature
2	4	u8[60]	60	Reserved

Table 110: System temperature packet

11.5 Configuration Packets

Configuration packets can be both read from and written to the Boreas. On many of the configuration packets the first byte is a permanent flag. A zero in this field indicates that the settings will be lost on reset, a one indicates that they will be permanent (i.e. stored in flash).

This section covers the following topics:

Packet ID	Name	Length	R/W
Configuration Packets			
180	11.5.1 Packet Timer Period Packet	4	R/W
181	11.5.2 Packets Period Packet	Varies	R/W
182	11.5.3 Baud Rates Packet	17	R/W
185	11.5.4 Installation Alignment Packet	73	R/W
186	11.5.5 Filter Options Packet	17	R/W
188	11.5.6 GPIO Configuration Packet	13	R/W
192	11.5.7 Odometer Configuration Packet	8	R/W
193	11.5.8 Set Zero Orientation Alignment Packet	5	W

Packet ID	Name	Length	R/W
194	11.5.9 Reference Point Offsets Packet	49	R/W
195	11.5.10 GPIO Output Configuration Packet	183	R/W
198	11.5.11 User Data Packet	64	R/W
199	11.5.12 GPIO Input Configuration Packet	65	R/W
203	11.5.13 CAN Configuration Packet	30	R/W

11.5.1 Packet Timer Period Packet

Packet Timer Period Packet				
Packet ID		180		
Length		4		
Read / Write		Read / Write		
Field #	Bytes Offset	Data Type	Size	Description
1	0	u8	1	Permanent
2	1	u8	1	11.5.1.1 UTC Synchronisation
3	2	u16	2	11.5.1.2 Packet Timer Period

Table 111: Packet Timer Period Packet

11.5.1.1 UTC Synchronisation

This is a boolean value that determines whether or not the packet timer is synchronised with UTC time, with zero for disabled and one for enabled. For UTC Synchronisation to be enabled the packet timer period must multiply into 1000000 evenly. For example if the packet timer period is 10000 (10 ms), $1000000/10000 = 100$ which is valid for UTC synchronisation. If the packet timer period is 15000 (15 ms), $1000000/15000 = 66.6666$ which is not valid for UTC synchronisation. To get the rate, use the following formula:

$$\text{Packet Timer Rate} = 1000000/(\text{Packet Timer Period}) \text{ Hz}$$

11.5.1.2 Packet Timer Period

This is a value in microseconds that sets the master packet timer period. The minimum value is 1000 (1 ms) or 1000 Hz and the maximum value is 65000 (65 ms) or 15.38 Hz. The packet timer period must be in increments of 1000.

11.5.2 Packets Period Packet

This packet allows the user to configure, add, remove, modify and clear state packets (packets 20 through 180).

Note: This packet will only affect the port from which the packet is sent, leaving the other ports unaffected. e.g. If you are connected to the Primary serial port, sending this packet will only change the ANPP output for the Primary serial port.

Packets Period Packet	
Packet ID	181

Packets Period Packet				
Length		2 + (5 x number of packet periods)		
Read / Write		Read / Write		
Field #	Bytes Offset	Data Type	Size	Description
1	0	u8	1	Permanent
2	1	u8	1	Clear Existing Packet Periods
3	2	u8	1	Packet ID
4	3	u32	4	Packet Period
+				Fields 3-4 repeat for additional packet periods

Table 112: Packets Period Packet

11.5.2.1 Clear Existing Packets

This is a boolean field, when set to one it deletes any existing packet rates. When set to zero existing packet rates remain. Only one packet rate can exist per packet ID, so new packet rates will overwrite existing packet rates for the same packet ID.

11.5.2.2 Packet Period

This indicates the period in units of the packet timer period. The packet rate can be calculated as follows.

$$\text{Packet Rate} = 1000000 / (\text{Packet Period} \times \text{Packet Timer Period}) \text{ Hz}$$

For example if the packet timer period is set to 1000 (1 ms). Setting packet ID 20 with a packet period of 50 will give the following.

$$\text{Packet 20 Rate} = 1000000 / (50 \times 1000)$$

$$\text{Packet 20 Rate} = 20 \text{ Hz}$$

11.5.3 Baud Rates Packet

Baud Rates Packet				
Packet ID		182		
Length		17		
Read / Write		Read / Write		
Field #	Bytes Offset	Data Type	Size	Description
1	0	u8	1	Permanent
2	1	u32	4	Primary RS232 and RS422 see 11.5.3.1 Supported Baud Rate
3	5	u32	4	GPIO 1 & 2 Maximum Baud Rate 250000 see 11.5.3.1 Supported Baud Rate
4	9	u32	4	Auxiliary RS232 see 11.5.3.1 Supported Baud Rate
5	13		4	Reserved (set to zero)

Table 113: Baud Rates Packet

11.5.3.1 Supported Baud Rate

Note: Not all Advanced Navigation products support minimum and maximum baud rates.

Supported Baud Rates - Bits 0-30
2400
4800
9600
19200
38400
57600
115200
230400
250000
460800
500000
800000
921600
1000000
1250000
2000000
4000000

Table 114: Supported Baud Rates

11.5.4 Installation Alignment Packet

Installation Alignment Packet				
Packet ID		185		
Length		73		
Read / Write		Read / Write		
Field #	Bytes Offset	Data Type	Size	Description
1	0	u8	1	Permanent
2	1	fp32	4	Alignment DCM[0][0]
3	5	fp32	4	Alignment DCM[0][1]
4	9	fp32	4	Alignment DCM[0][2]
5	13	fp32	4	Alignment DCM[1][0]
6	17	fp32	4	Alignment DCM[1][1]

Installation Alignment Packet				
7	21	fp32	4	Alignment DCM[1][2]
8	25	fp32	4	Alignment DCM[2][0]
9	29	fp32	4	Alignment DCM[2][1]
10	33	fp32	4	Alignment DCM[2][2]
11	37	fp32	4	GNSS antenna offset X (m)
12	41	fp32	4	GNSS antenna offset Y (m)
13	45	fp32	4	GNSS antenna offset Z (m)
14	49	fp32	4	Odometer offset X (m) ¹
15	53	fp32	4	Odometer offset Y (m) ¹
16	57	fp32	4	Odometer offset Z (m) ¹
17	61	fp32	4	External data offset X (m) ²
18	65	fp32	4	External data offset Y (m) ²
19	69	fp32	4	External data offset Z (m) ²
¹ Odometer offset is used for Odometer and DVL input				
² External data offset is used for NMEA input, External GNSS and Air Data Unit				

Table 115: Installation Alignment Packet

11.5.4.1 Alignment DCM

The alignment DCM (Direction Cosine Matrix) is used to represent an alignment offset of Boreas from its standard alignment. A DCM is used rather than Euler angles for accuracy reasons. To convert Euler angles to DCM, use the formula below with angles in radians.

$$DCM[0][0] = \cos(\text{heading}) * \cos(\text{pitch})$$

$$DCM[0][1] = \sin(\text{heading}) * \cos(\text{pitch})$$

$$DCM[0][2] = -\sin(\text{pitch})$$

$$DCM[1][0] = -\sin(\text{heading}) * \cos(\text{roll}) + \cos(\text{heading}) * \sin(\text{pitch}) * \sin(\text{roll})$$

$$DCM[1][1] = \cos(\text{heading}) * \cos(\text{roll}) + \sin(\text{heading}) * \sin(\text{pitch}) * \sin(\text{roll})$$

$$DCM[1][2] = \cos(\text{pitch}) * \sin(\text{roll})$$

$$DCM[2][0] = \sin(\text{heading}) * \sin(\text{roll}) + \cos(\text{heading}) * \sin(\text{pitch}) * \cos(\text{roll})$$

$$DCM[2][1] = -\cos(\text{heading}) * \sin(\text{roll}) + \sin(\text{heading}) * \sin(\text{pitch}) * \cos(\text{roll})$$

$$DCM[2][2] = \cos(\text{pitch}) * \cos(\text{roll})$$

11.5.5 Filter Options Packet

Filter Options Packet				
Packet ID		186		
Length		17		
Read / Write		Read / Write		
Field #	Bytes Offset	Data Type	Size	Description
1	0	u8	1	Permanent
2	1	u8	1	11.5.5.1 Vehicle Types
3	2	u8	1	Internal GNSS enabled (boolean)
4	3	u8	1	Reserved (set to zero)
5	4	u8	1	Atmospheric altitude enabled (boolean)
6	5	u8	1	Velocity heading enabled (boolean)
7	6	u8	1	Reversing detection enabled (boolean)
8	7	u8	1	Motion analysis enabled (boolean)
9	8	u8	1	Reserved (set to zero)
10	9		8	Reserved (set to zero)

Table 116: Filter Options Packet

11.5.5.1 Vehicle Types

Value	Description
0	Unlimited
1	Bicycle or Motorcycle
2	Car
3	Hovercraft

Value	Description
4	Submarine
5	3D Underwater Vehicle
6	Fixed Wing Plane
7	3D Aircraft
8	Human
9	Boat
10	Large Ship
11	Stationary
12	Stunt Plane
13	Race Car
14	Train

Table 117: Vehicle Types

11.5.6 GPIO Configuration Packet

GPIO Configuration Packet				
Packet ID				188
Length				13
Read / Write				Read / Write
Field #	Bytes Offset	Data Type	Size	Description
1	0	u8	1	Permanent
2	1	u8	1	GPIO1 function. See 11.5.6.1 GPIO Functions
3	2	u8	1	GPIO2 function. See 11.5.6.1 GPIO Functions
4	3	u8	1	Auxiliary RS232 transmit function. See 11.5.6.2 Auxiliary Functions
5	4	u8	1	Auxiliary RS232 receive function. See 11.5.6.2 Auxiliary Functions
6	5	u8	1	11.5.6.3 GPIO Voltage Selection
7	6		7	Reserved (set to zero)

Table 118: GPIO Configuration Packet

11.5.6.1 GPIO Functions

Value	Description	GPIO Function Type
0	Inactive	GPIO1, GPIO2
1	1PPS Output	
2	GNSS Fix Output	
3	Odometer Input	
4	Zero Velocity Input	
5	Pitot Tube Input	
6	NMEA Input	GPIO2
7	NMEA Output	GPIO1
8	Novatel GNSS Input	GPIO2
9	Topcon GNSS Input	
11	ANPP Input	
12	ANPP Output	GPIO1
14	Disable GNSS	GPIO1, GPIO2
15	Disable Pressure	GPIO1, GPIO2
16	Set Zero Orientation Alignment	
17	System State Packet Trigger	
18	Raw Sensors Packet Trigger	
19	RTCM Differential GNSS Corrections Input	GPIO2
20	Trimble GNSS Input	
21	u-blox GNSS Input	
22	Hemisphere GNSS Input	
23	Teledyne DVL Input	
24	Tritech USBL Input	
25	Linkquest DVL Input	

Value	Description	GPIO Function Type
26	Pressure Depth Transducer	GPIO1, GPIO2
27	Left Wheel Speed Sensor	
28	Right Wheel Speed Sensor	
29	1PPS Input	
30	Wheel Speed Sensor	
31	Wheel Encoder Phase A	
32	Wheel Encoder Phase B	
33	Event 1 Input	
34	Event 2 Input	
35	Linkquest USBL Input	GPIO2
38	GNSS Receiver Passthrough	GPIO1, GPIO2
39	TSS1 Output	GPIO1
40	Simrad 1000 Output	
41	Simrad 3000 Output	
42	Serial Port Passthrough	GPIO1, GPIO2
43	Gimbal Encoder Phase A	
44	Gimbal Encoder Phase B	
45	Odometer Direction, Forward Low	
46	Odometer Direction, Forward High	
51	Nortek DVL Input	GPIO2
53	Reverse Alignment, Forward Low	GPIO1, GPIO2
54	Reverse Alignment, Forward High	
55	Zero Angular Velocity Input	

Table 119: GPIO functions

11.5.6.2 Auxiliary Functions

Value	Description	Auxiliary Function Type
0	Inactive	Transmit, Receive
1	1PPS Output	Transmit
2	GNSS Fix Output	
3	Odometer Input	Receive
4	Zero Velocity Input	
5	Pitot Tube Input	
6	NMEA Input	

Value	Description	Auxiliary Function Type
7	NMEA Output	Transmit
8	Novatel GNSS Input	Receive
9	Topcon GNSS Input	
11	ANPP Input	
12	ANPP Output	Transmit
14	Disable GNSS	Receive
15	Disable Pressure	
16	Set Zero Orientation Alignment	
17	System State Packet Trigger	
18	Raw Sensors Packet Trigger	
19	RTCM Differential GNSS Corrections Input	
20	Trimble GNSS Input	
21	u-blox GNSS Input	
22	Hemisphere GNSS Input	
23	Teledyne DVL Input	
24	Tritech USBL Input	
25	Linkquest DVL Input	
26	Pressure Depth Transducer	
27	Left Wheel Speed Sensor	
28	Right Wheel Speed Sensor	
29	1PPS Input	
30	Wheel Speed Sensor	
33	Event 1 Input	
34	Event 2 Input	
35	Linkquest USBL Input	
38	GNSS Receiver Passthrough	Transmit, Receive
39	TSS1 Output	Transmit
40	Simrad 1000 Output	
41	Simrad 3000 Output	
42	Serial Port Passthrough	Transmit, receive

Value	Description	Auxiliary Function Type
45	Odometer Direction, Forward Low	Receive
46	Odometer Direction, Forward High	
51	Nortek DVL Input	
53	Reverse Alignment, Forward Low	
54	Reverse Alignment, Forward High	
55	Zero Angular Velocity Input	

Table 120: Auxiliary Functions

11.5.6.3 GPIO Voltage Selection

Value	Description
0	5V
1	3.3V
2	Power Disabled

Table 121: GPIO Voltage Selection

11.5.7 Odometer Configuration Packet

Odometer Configuration Packet				
Packet ID		192		
Length		8		
Read / Write		Read / Write		
Field #	Bytes Offset	Data Type	Size	Description
1	0	u8	1	Permanent
2	1	u8	1	Automatic pulse measurement active
3	2		2	Reserved (set to zero)
4	4	fp32	4	Pulse length (m)

Table 122: Odometer Configuration Packet

11.5.8 Set Zero Orientation Alignment Packet

Set Zero Orientation Alignment Packet				
Packet ID		193		
Length		5		
Read / Write		Write		
Field #	Bytes Offset	Data Type	Size	Description
1	0	u8	1	Permanent
2	1	u32	4	Verification sequence (set to 0x9A4E8055)

Table 123: Set Zero Orientation Alignment Packet

11.5.9 Reference Point Offsets Packet

The reference point offsets packet can be used to adjust the measurement point that all data is referenced to. By default all the values of this packet are zero and the measurement point that all data is referenced to is the centre of the Boreas unit. The primary reference point offset can be used to adjust the measurement point to a different location on the vehicle, in the body co-ordinate frame. The primary reference point offset applies to all data output including NMEA etc as well as heave point 1.

Heave point 2 is reserved for use for the Centre of Gravity (COG) Lever Arm offset to improve coarse heading alignment.

The other heave point offsets do not apply to heave point 1 in the [11.4.35 Heave Packet](#).

Reference Point Offsets Packet				
Packet ID		194		
Length		49		
Read / Write		Read / Write		
Field #	Bytes Offset	Data Type	Size	Description
1	0	u8	1	Permanent
2	1	fp32	4	Heave point 1 offset X (m) / Primary reference point offset X (m)
3	5	fp32	4	Heave point 1 offset Y (m) / Primary reference point offset Y (m)
4	9	fp32	4	Heave point 1 offset Z (m) / Primary reference point offset Z (m)
5	13	fp32	4	Heave point 2 offset X (m) N.B. Used for COG Lever Arm Offset
6	17	fp32	4	Heave point 2 offset Y (m) N.B. Used for COG Lever Arm Offset
7	21	fp32	4	Heave point 2 offset Z (m) N.B. Used for COG Lever Arm Offset
8	25	fp32	4	Heave point 3 offset X (m)
9	29	fp32	4	Heave point 3 offset Y (m)
10	33	fp32	4	Heave point 3 offset Z (m)
11	37	fp32	4	Heave point 4 offset X (m)
12	41	fp32	4	Heave point 4 offset Y (m)
13	45	fp32	4	Heave point 4 offset Z (m)

Table 124: Reference Point Offsets Packet

11.5.10 GPIO Output Configuration Packet

GPIO Output Configuration Packet				
Packet ID				195
Length				183
Read / Write				Read / Write
Field #	Bytes Offset	Data Type	Size	Description
1	0	u8	1	Permanent
2	1	u8	1	Auxiliary port Input Mode. See 11.5.10.1 Port Input Modes
3	2	u8	1	Auxiliary port Output Mode. See 11.5.10.2 Port Output Modes
4	3	u8	1	Auxiliary port NMEA fix behaviour. See 11.5.10.3 NMEA Fix Behaviour
5	4	u8	1	Auxiliary port GPZDA Rates. See 11.5.10.4 Port Output Rates
6	5	u8	1	Auxiliary port GPGGA Rates. See 11.5.10.4 Port Output Rates
7	6	u8	1	Auxiliary port GPVTG Rates. See 11.5.10.4 Port Output Rates
8	7	u8	1	Auxiliary port GPRMC Rates. See 11.5.10.4 Port Output Rates
9	8	u8	1	Auxiliary port GPHDT Rates. See 11.5.10.4 Port Output Rates
10	9	u8	1	Auxiliary port GPGLL Rates. See 11.5.10.4 Port Output Rates
11	10	u8	1	Auxiliary port PASHR Rates. See 11.5.10.4 Port Output Rates
12	11	u8	1	Auxiliary port TSS1 Rates. See 11.5.10.4 Port Output Rates
13	12	u8	1	Auxiliary port Simrad Rates. See 11.5.10.4 Port Output Rates
14	13	u8	1	Auxiliary port GPROT Rates. See 11.5.10.4 Port Output Rates
15	14	u8	1	Auxiliary port GPHEV Rates. See 11.5.10.4 Port Output Rates
16	15	u8	1	Auxiliary port GPGSV Rates. See 11.5.10.4 Port Output Rates
17	16	u8	1	Auxiliary port PFECAtt Rates. See 11.5.10.4 Port Output Rates
18	17	u8	1	Auxiliary port PFECHe Rates. See 11.5.10.4 Port Output Rates

GPIO Output Configuration Packet				
				put Rates
19	18	u8	1	Auxiliary port GPGST Rates. See 11.5.10.4 Port Output Rates
20	19	u8[8]	8	Reserved (set to zero)
+				Fields 2-20 Repeat 6 more times (a total of 7 copies) for: GPIO port Logging port Data Port #1 Data Port #2 Data Port #3 Data Port #4

Table 125: GPIO Output Configuration Packet

11.5.10.1 Port Input Modes

Value	Description
0	Inactive
6	NMEA0183
11	ANPP
38	GNSS Receiver Passthrough

Table 126: Port Input Modes

11.5.10.2 Port Output Modes

Value	Description
0	Inactive
7	NMEA0183
12	ANPP
38	GNSS Receiver Passthrough
39	TSS1
40	Simrad 1000
41	Simrad 3000

Table 127: Port Output Modes

Note: The Port Input and Output Modes are read only for the auxiliary and GPIO ports. For compatibility with legacy devices, the modes for these two ports are set using the GPIO Configuration Packet.

11.5.10.3 NMEA Fix Behaviour

Value	Description
0	Normal
1	Always indicate 3D fix when the navigation filter is ini-

Value	Description
	tialised

Table 128: NMEA Fix Behaviour

11.5.10.4 Port Output Rates

Value	Bit 3	Bit 2	Bit 1	Bit 0	Description
0	0	0	0	0	Disabled
1	0	0	0	1	0.1 Hz
2	0	0	1	0	0.2 Hz
3	0	0	1	1	0.5 Hz
4	0	1	0	0	1 Hz
5	0	1	0	1	2 Hz
6	0	1	1	0	5 Hz
7	0	1	1	1	10 Hz
8	1	0	0	0	25 Hz
9	1	0	0	1	50 Hz
10	1	0	1	0	8 Hz

Table 129: Port Output Rates

11.5.11 User Data Packet

This packet is for storage of users data. The data itself is not used by Boreas.

User Data Packet				
Packet ID		198		
Length		64		
Read / Write		Read / Write		
Field #	Bytes Offset	Data Type	Size	Description
1	0		64	User Data

Table 130: User Data Packet

11.5.12 GPIO Input Configuration Packet

GPIO Input Configuration Packet				
Packet ID		199		
Length		65		
Read / Write		Read / Write		
Field #	Bytes Offset	Data Type	Size	Description
1	0	u8	1	Permanent

GPIO Input Configuration Packet				
2	1	fp32	4	Gimbal radians per encoder tick
3	5		60	Reserved (set to zero)

Table 131: GPIO Input Configuration Packet

11.5.13 CAN Configuration Packet

CAN Configuration Packet				
Packet ID			203	
Length			11	
Read / Write			Read / Write	
Field #	Bytes Offset	Data Type	Size	Description
1	0	u8	1	Permanent
2	1	u8	1	Enabled
3	2	u32	4	Baud Rate
4	6	u8	1	CAN Protocol
5	7	u8	4	Reserved (set to zero)

Table 132: CAN Configuration Packet

11.5.13.1 CAN Protocol

Value	Description
0	CANopen

Table 133: CAN Protocol

12 Reference Information

This chapter is a learning reference that briefly covers knowledge essential to understanding Boreas and INS generally. It explains the following concepts in simple terms so that people unfamiliar with the technology may understand it:

- [12.1 Technology Overview](#), including Global Navigation Satellite System (GNSS), Inertial Navigation System (INS) and Attitude and Heading Reference System (AHRS)
- [12.2 The Sensor Co-ordinate Frame](#)
- [12.3 The Body Co-ordinate Frame](#)
- [12.4 Roll, Pitch and Heading](#)
- [12.5 Geodetic Co-ordinate System](#)
- [12.6 NED Co-ordinate Frame](#)
- [12.7 ECEF Co-ordinate Frame](#)

12.1 Technology Overview

12.1.1 GNSS

GNSS stands for Global Navigation Satellite System. A GNSS consists of a set of satellites in medium Earth orbit that broadcast navigation signals with a common operator. These navigation signals can be picked up by a GNSS receiver on the earth to estimate that receiver's position and velocity. For a long time the only operational GNSS was the United States GPS. However, the Russian GLONASS, the Chinese BeiDou GNSS, and the European Union's Galileo GNSS are fully operational.

GNSS provides a fairly accurate absolute position (down to 1.2 metres without assistance and as low as 8 mm with) and velocity (as low as 0.007 metres/second). The main drawback of GNSS is that the receiver must have a clear signal from at least 4 satellites to function. GNSS signals are very weak and struggle to penetrate through buildings, trees and other objects obstructing an uninterrupted view of the sky. GNSS can also occasionally drop out due to disturbances in the upper atmosphere, or the presence of jammers.

12.1.2 AHRS

AHRS stands for Attitude and Heading Reference System. An AHRS uses accelerometers and gyroscopes combined in a mathematical algorithm to provide orientation. Orientation consists of the three body angles roll, pitch and heading.

12.1.3 INS

INS stands for Inertial Navigation System. An inertial navigation system can provide position and velocity similar to GNSS but with some major differences. The principle of inertial navigation is the measurement of acceleration, which is then integrated into velocity. The velocity is then further integrated to estimate position. Due to noise in the measurement and the compounding of that noise through the integration steps, inertial navigation has an error that increases exponentially over time. Inertial navigation systems have a very low relative error over short time periods but over long time periods the error can increase enormously.

12.1.4 GNSS/INS

By combining GNSS and INS together in a mathematical algorithm, it is possible to take advantage of the benefits of the long-term precision of GNSS and the short-term accuracy of inertial sensors. This provides an

enhanced position and velocity solution that can withstand GNSS drop outs.

Note: Boreas can be upgraded to full INS capability through a software license upgrade. As an INS it can be interfaced to any of the leading brands of GNSS receivers to create an OEM GNSS/INS solution.

12.2 The Sensor Co-ordinate Frame

Inertial sensors have 3 different axes: X, Y and Z and these determine the references around which angles and accelerations are measured. It is very important to align these axes correctly in installation, otherwise the system won't work correctly.

These axes are marked on the top of the device as shown in [Figure 89: Boreas Axes](#) below, with the X axis pointing in the direction of the connectors, the Z axis pointing down through the base of the unit and the Y axis pointing off to the right.

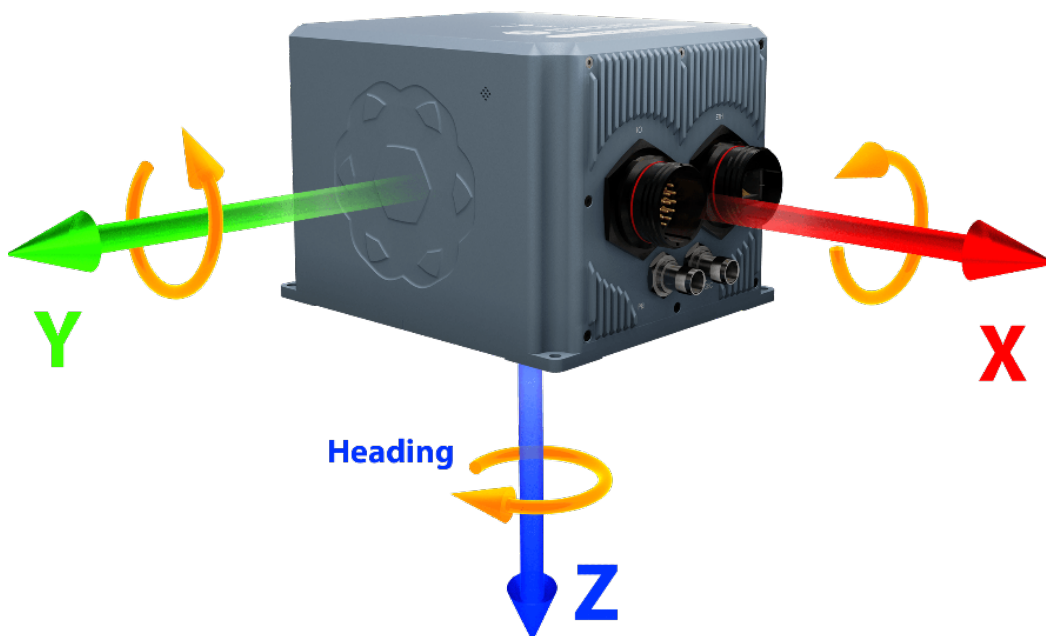

Figure 89: Boreas Axes

12.2.1 Right Hand Rule

When installed in an application the X axis should be aligned such that it points forwards and the Z axis aligned so that it points down when the system is level. A good way to remember the sensor axes is the right hand rule, which is visualised in [Figure 90: First Right-hand Rule](#).

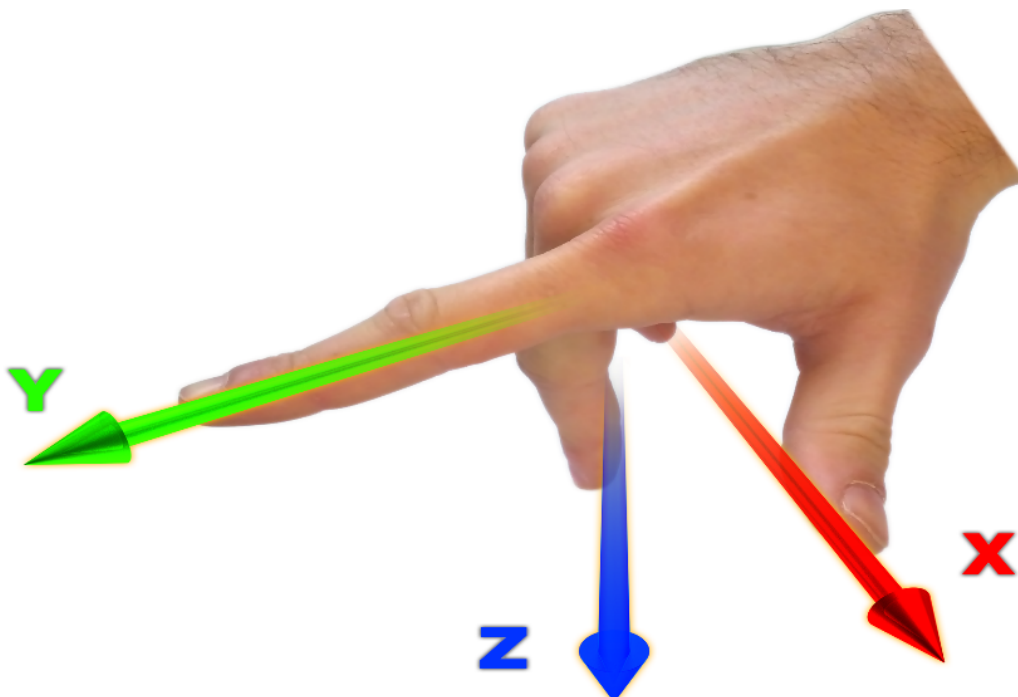

Figure 90: First Right-hand Rule

You take your right hand and extend your thumb, index and middle. Your thumb then denotes the positive X axis, your index denotes the positive Y axis and your middle denotes the positive Z axis.

12.3 The Body Co-ordinate Frame

Also known as the vehicle co-ordinate (reference) frame, this can be described most easily using a car (the body or vehicle) as an example. The forward direction of travel for a car is the positive X axis, out to the right of the car is the positive Y axis, and down is the positive Z axis. The distinction between the sensor co-ordinate frame and the body co-ordinate frame becomes important when the INS device is not mounted with its axes aligned to the vehicle axes, for example when the INS is mounted with a 90 degree heading rotation. Offset measurements, which are described later in this document, will always be in the body co-ordinate frame to remove any INS alignment variations. Generally any data output by the INS using the X, Y and Z axes will be using the body co-ordinate frame.

12.4 Roll, Pitch and Heading

Orientation can be described by the three angles roll, pitch and heading: these are known as the Euler angles. The rotation axes of roll, pitch and heading are shown visually in [Figure 89: Boreas Axes](#). The arrow indicates the positive rotation direction.

Roll is the angle around the X axis and is zero when the unit is level. Pitch is the angle around the Y axis and is zero when the unit is level. Heading is the angle around the Z axis and is zero when the positive X axis is pointing to true north.

12.4.1 Second Right Hand Rule

The two right hand rules are often the best way to memorise the sensor axes and directions of positive rotation. The first right hand rule gives the positive axis directions and is described in [12.2 The Sensor Co-ordinate Frame](#). The second right hand rule shown in the figure below provides the direction of positive rotation. To use

it, point your thumb in the positive direction of that axis, then the direction that your fingers curl over shows the positive rotation on that axis.

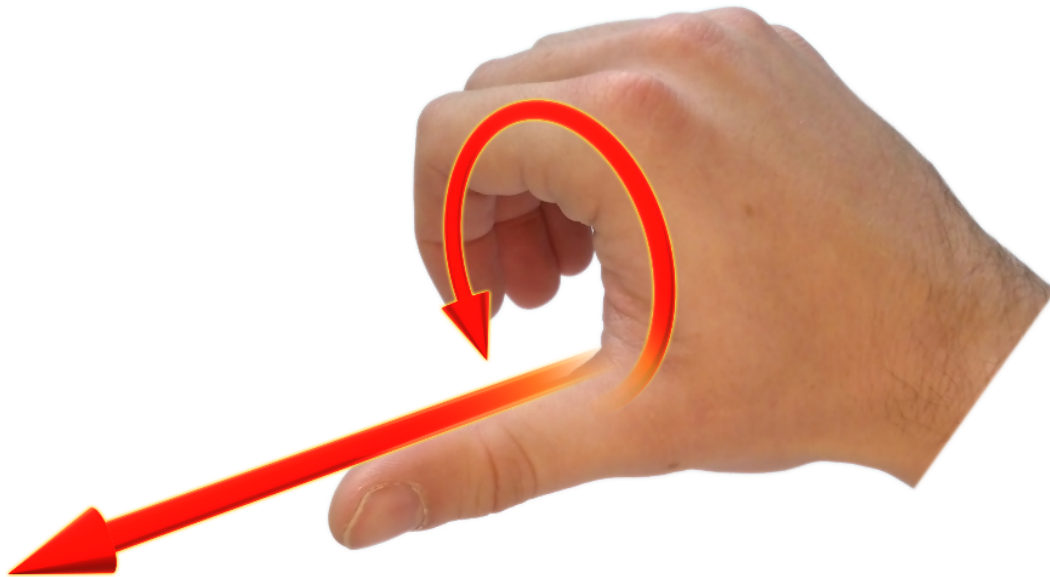

Figure 91: Second right Hand Rule

12.4.2 Rotation Order

When multiple axes are rotated, to imagine the final orientation the three rotations must be performed in the order heading first, then pitch and then roll. To deduce the final orientation the unit should first be considered level with the X axis pointing north and the Z axis pointing down. Heading is applied first, then pitch is applied and finally roll is applied to give the final orientation. This can be hard for some people to grasp at first and is often best learned experimentally by rotating Boreas with your hand whilst watching the orientation plot in real time on the computer.

12.5 Geodetic Co-ordinate System

The geodetic co-ordinate system is the most popular way of describing an absolute position on the Earth. It is made up of two angles, latitude and longitude, combined with a height relative to an ellipsoid.

12.5.1 Latitude and Longitude

Latitude is the angle that specifies the north to south position of a point on the Earth's surface, reported as $\pm 90^\circ$. Longitude is the angle that specifies the east to west position of a point on the Earth's surface, reported as $\pm 180^\circ$. The line of zero latitude is the equator, and the line of zero longitude is the prime meridian. See [Figure 92: Latitude and longitude represented visually to describe a position on an ellipsoid](#).

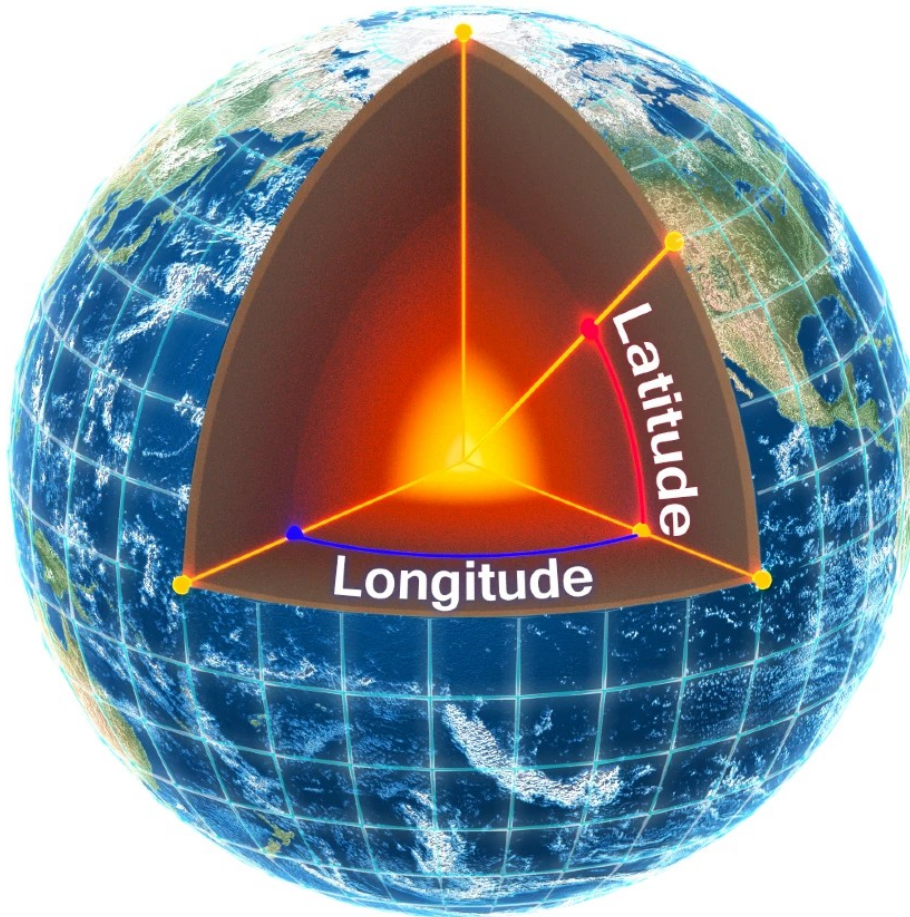

Figure 92: Latitude and longitude represented visually to describe a position on an ellipsoid

The figure below shows latitude and longitude on a map of the world, represented with a standard Mercator projection.

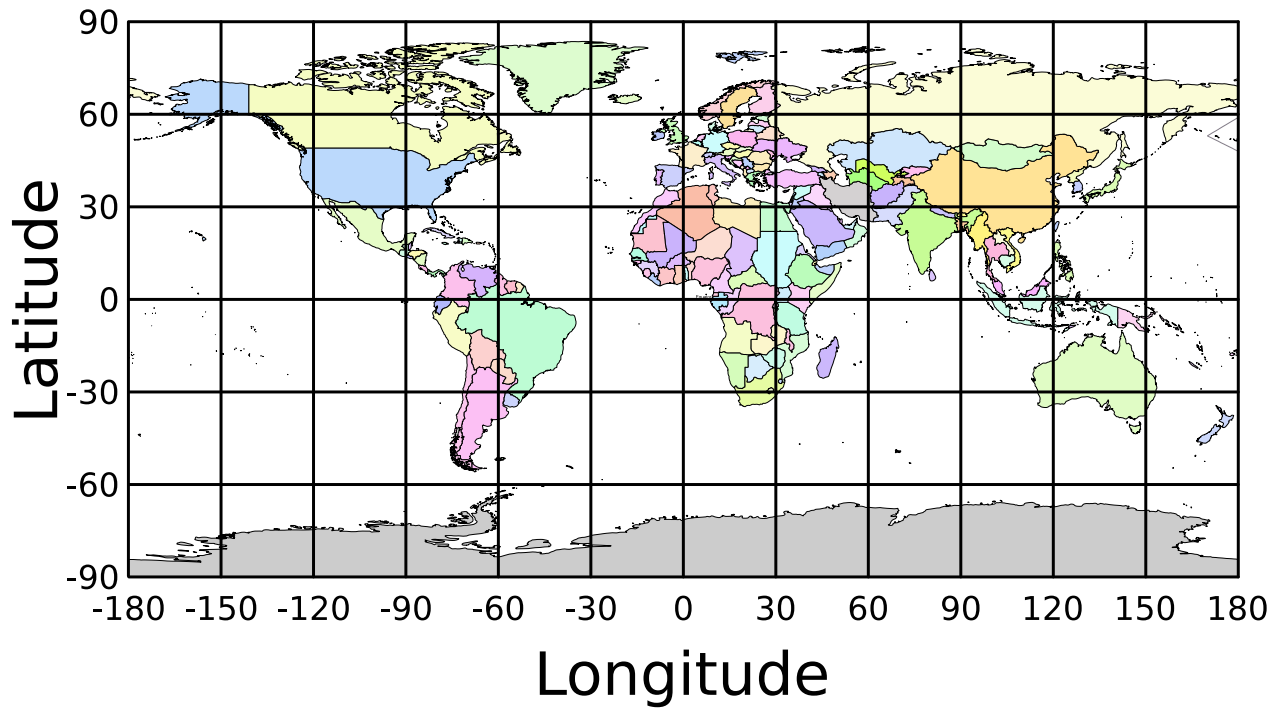

Figure 93: World map showing latitudes and longitudes

Latitude and longitude give the 2D point on the surface of the Earth. These are combined with height to give the 3D position on the Earth.

12.5.2 Height

Any height data output by Advanced Navigation devices is the height referenced the WGS84 reference ellipsoid. The WGS84 reference ellipsoid is a smooth mathematical model that approximates the form of the surface of the earth. The ellipsoid height (as used by GNSS) is not referenced to mean sea level; the height from the EGM96 geoid (orthometric height) approximates the height above mean sea level (MSL).

See [Figure 94: Orthometric, ellipsoid and geoid height diagram](#) below for a visual representation of geoid height, ellipsoid height and orthometric height (height above mean sea level).

Note:

Ellipsoid height refers to the height of a point of interest referenced to the WGS84 reference ellipsoid. Geoid height refers to the height of the EGM96 geoid referenced to the WGS84 reference ellipsoid at a point of interest.

Orthometric height is the height at a point of interest referenced to the EGM96 geoid.

All heights can be either positive or negative dependant upon direction from the reference surface.

$$H = h - N$$



Figure 94: Orthometric, ellipsoid and geoid height diagram

The value required to convert the WGS84 ellipsoid height to orthometric height can be found in the geoid height packet, see [11.4.33 Geoid Height Packet](#).

12.6 NED Co-ordinate Frame

The NED (North East Down) co-ordinate frame is used to express velocities and relative positions. The origin of the co-ordinate frame is the current position. From that origin, the north axis points true north and parallel to the line of latitude at that point. The east axis points perpendicular to the north axis and parallel to the line of longitude at that point. The down axis points directly down towards the centre of the Earth. See the figure below for a graphical representation of the NED co-ordinate frame at a position on the Earth.

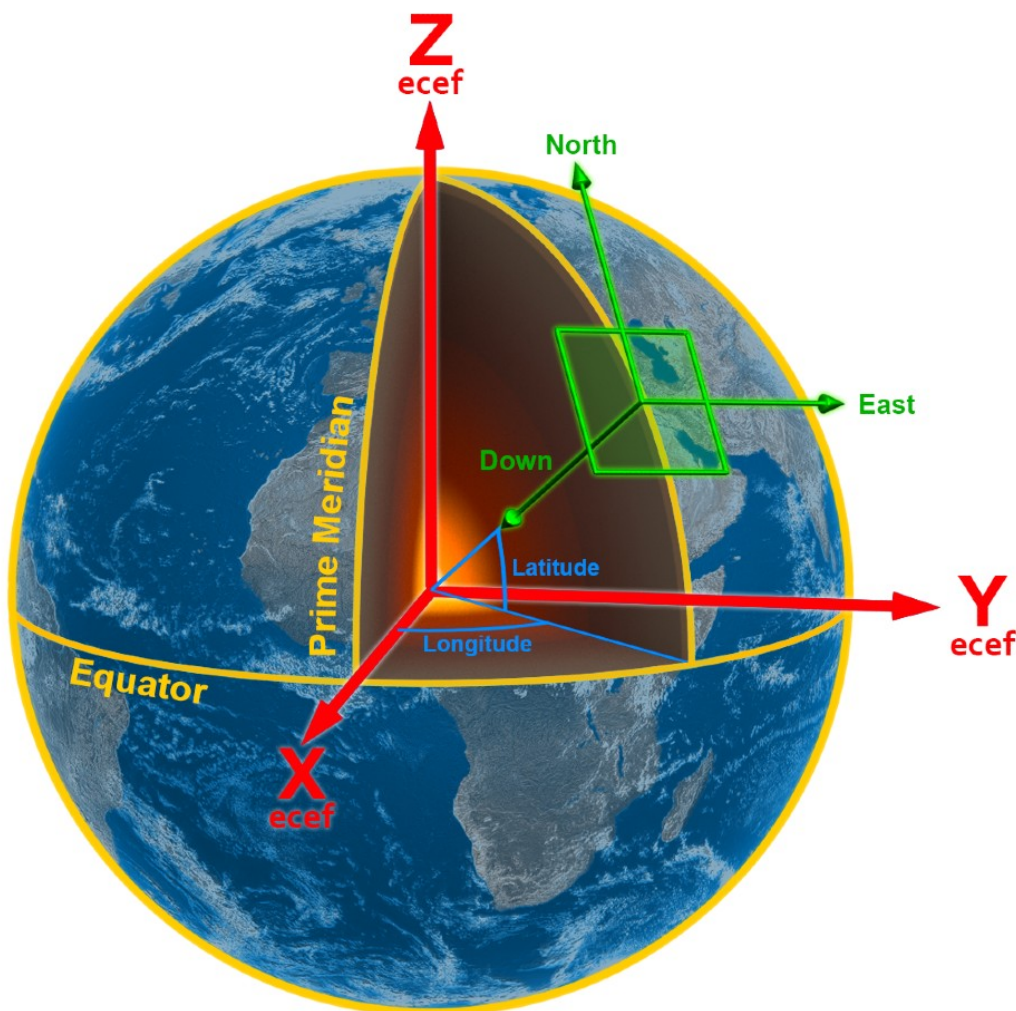

Figure 95: Graphic Showing Geodetic, NED and ECEF Co-ordinates

12.7 ECEF Co-ordinate Frame

The ECEF (Earth-centred earth-fixed) co-ordinate frame is a Cartesian co-ordinate frame used to represent absolute positions on the Earth. Its origin is at the centre of the Earth. ECEF is an alternative to the geodetic co-ordinate frame. It is represented by the three axes X, Y and Z which are presented graphically in [Figure 95: Graphic Showing Geodetic, NED and ECEF Co-ordinates](#). ECEF positions can be retrieved from Advanced Navigation products, however the geodetic system is used as the default.