

**ADVANCED  
NAVIGATION**

# **Subsonus Tag Reference Manual**





## Table of Contents

1	Revision History.....	5
2	Firmware Changelog.....	6
3	Hardware Changelog.....	7
4	Introduction.....	8
5	Foundation Knowledge.....	9
5.1	USBL Acoustic Positioning.....	9
5.2	Orientation.....	10
5.3	Sensor Co-ordinate Frame.....	10
5.4	Roll, Pitch and Heading.....	11
5.4.1	Second Right Hand Rule.....	11
5.4.2	Rotation Order.....	12
6	Evaluation Kit.....	13
6.1	Evaluation Kit Contents.....	13
6.2	Evaluation Kit Quick Start Guide.....	13
7	Part Numbers and Ordering Options.....	15
7.1	Subsonus Surface Kit.....	15
7.2	Subsonus Tag Kit.....	15
7.3	Accessories.....	16
8	Specifications.....	17
8.1	Mechanical Drawings.....	17
8.1.1	Positioning with Subsonus USBL.....	18
8.2	Acoustics.....	18
8.3	Sensors.....	18
8.4	Display.....	18
8.5	Battery.....	19
8.6	Hardware.....	19
8.7	Serial Number.....	19
9	Installation.....	20
9.1	Installation Check-list.....	20
9.2	Subsonus Tag Mounting.....	22
9.3	Subsonus Tag Addresses.....	22
9.3.1	Device Address Usage.....	23
9.3.2	Automatic Address Assignment.....	23
9.3.3	Manual Address Assignment.....	23
10	Operation.....	24
10.1	Initialisation.....	24
10.2	Electronic Paper Display.....	24
10.3	Qi Charging.....	24
10.3.1	Qi Charger Alignment.....	25
10.3.2	Qi Charging Rate.....	25
10.3.3	Qi Charger Power Supply.....	26
10.4	Bluetooth.....	26
10.4.1	Bluetooth Discovery.....	26
10.4.2	Bluetooth Connection.....	27
10.5	Firmware Update.....	27
10.6	Shipping Mode.....	27
10.7	Battery.....	28
10.7.1	Storage.....	28
10.7.2	Environmental Protection.....	28



10.8	Operating Mode.....	28
10.8.1	Performance Mode.....	28
10.8.2	Endurance Mode.....	29
10.9	Acoustic Data Protocol.....	29
10.10	Data sources.....	29
10.10.1	Orientation.....	29
10.10.2	Magnetic Heading.....	29
10.11	Environmental Exposure.....	30
10.11.1	Temperature.....	30
10.11.2	Chemical.....	30
10.11.3	Shocks.....	30
10.11.4	Mounting Stress.....	30
11	Subsonus Tag Manager.....	31
11.1	Software Changelog.....	31
11.2	System Requirements.....	31
11.3	Installation.....	31
11.4	Tag Discovery.....	33
11.5	Menu.....	34
11.6	Summary.....	36
11.6.1	Status.....	36
11.6.2	Battery.....	37
11.6.3	Configuration.....	37
11.6.4	System Status.....	38
11.7	Device Information.....	38
11.8	Sensors.....	39
11.9	General.....	39
11.10	Advanced.....	40
11.11	Firmware.....	41
11.11.1	Packaged Firmware.....	42
11.11.2	Firmware from file.....	42
11.11.3	Bootloader.....	44
11.11.4	Firmware Upload failure.....	45
11.12	Shipping Mode.....	45
11.13	Magnetic Calibration.....	45
11.13.1	Begin New 3D Magnetic Calibration.....	46
11.13.2	Begin New 2D Magnetic Calibration.....	51
11.13.3	Restore Factory Defaults.....	55
11.13.4	View / Edit Calibration Values.....	55
11.14	Administration.....	56
11.14.1	Set Shipping Mode.....	57
11.14.2	Factory Restore.....	58
11.14.3	Save Configuration.....	58
11.14.4	Download Internal Logs.....	58
11.15	Troubleshooting.....	58
11.15.1	Bluetooth Permissions.....	59
11.15.2	Discovery not working.....	59
12	Configuration.....	60
12.1	Device Configuration.....	60
12.1.1	Display Name.....	60
12.1.2	Operation Mode.....	60



12.1.3	Device Address.....	60
12.1.4	Range.....	60
12.2	Alignment Configuration.....	60
12.2.1	Alignment Offset.....	60
12.3	Acoustic Data Priority.....	60
12.4	Shipping Mode.....	60
13	Maintenance.....	62
13.1	Inspections.....	62
13.1.1	Damage.....	62
13.1.2	Biofouling.....	62
13.2	Cleaning.....	62
14	Device Address.....	63
14.1	Device Address Tracking Behaviour.....	63
14.1.1	Subsonus Tag.....	63
14.1.1.1	Automatic Device Address.....	63
14.2	Hot Swap.....	63
14.3	Device Address Conflict.....	63
14.3.1	Device Address Conflict Display in Subsonus.....	63
15	Compliance.....	64
15.1	FCC.....	64
15.2	IC (Canada).....	64



## 1 Revision History

Version	Date	Changes
1.5	29/02/2024	Updated firmware changelog, section 2
1.4	22/10/2021	Updated firmware changelog, section 2 Added description of acoustic data protocol options, section 10.9
1.3	17/12/2019	Updated firmware changelog, section 2 Updated hardware changelog, section 3 Updated Tag Manager changelog, section 11.1
1.2	06/08/2019	Updated firmware changelog, section 2
1.1	26/03/2019	Updated firmware changelog, section 2 Updated hardware changelog, section 3 Updated Tag Manager changelog, section 11.1 Add magnetic calibration instructions, section 11.13 Add shipping mode button description, section 12.4 Update some Tag Manager images, section 11 Add description of shipping mode, section 10.6 Add description of firmware update 10.5 Add min/max storage temperature to section 10.11.1 Clarify long term storage in section 10.7.1
1.0	16/01/2019	Initial Release

Table 1: Revision history



## 2 Firmware Changelog

Version	Date	Changes
2.1	18/01/2024	Added support for hardware v1.5
2.0	22/10/2021	Added Acoustic Data Protocol options for “High Speed” mode and “High Reliability” mode. Note; this firmware is only compatible with Subsonus FW3.0 and newer,
1.3	17/12/2019	Support for hardware revision 1.4
1.2	06/08/2019	Added support for automatic dynamic transmit power
1.1	22/03/2019	Added magnetometer calibration procedure Added internal log downloads Improved battery performance in endurance mode Support for hardware revision 1.2
1.0	10/01/2019	Initial release

Table 2: Firmware changelog



### 3 Hardware Changelog

Version	Date	Changes
1.5	18/01/2023	Manufacturing improvements
1.4	17/12/2019	Manufacturing improvements
1.3	14/07/2019	Manufacturing improvements
1.2	05/03/2019	Manufacturing improvements Power efficiency improvements
1.1	10/01/2019	Internal manufacturing improvements No change to performance, function or specification
1.0	22/08/2018	Initial release

Table 3: Hardware changelog



## **4 Introduction**

Subsonus Tag is a low cost acoustic positioning transponder that operates with the Subsonus USBL. It features an integrated battery, wireless charging and a pressure tolerant display. Ultra low-power consumption allows operation for up to 18 months on one charge.

Subsonus Tag can provide amazing results but it does need to be set up properly. Please read this manual carefully to ensure success within your application.

If you have any questions please contact [support@advancednavigation.com](mailto:support@advancednavigation.com)





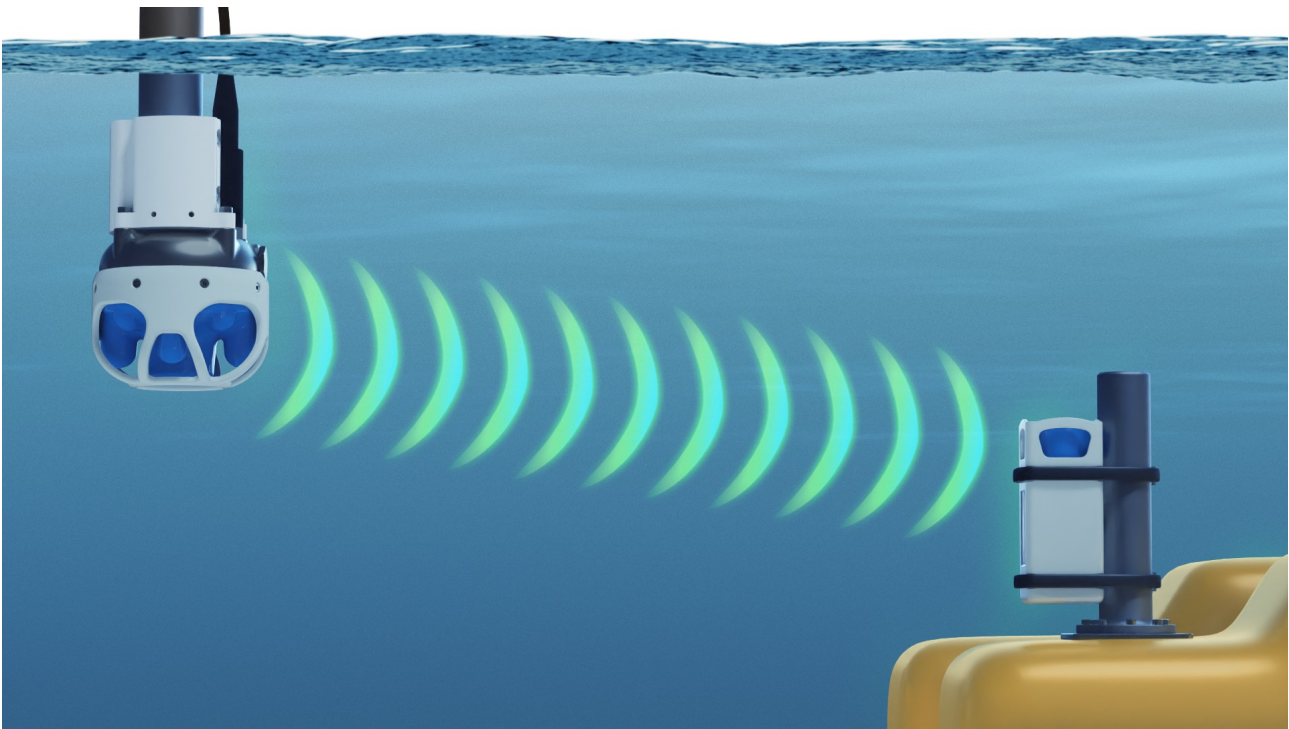
## **5 Foundation Knowledge**

This chapter is a learning reference that briefly covers knowledge essential to understanding Subsonus, Subsonus Tag and the following chapters.

### **5.1 USBL Acoustic Positioning**

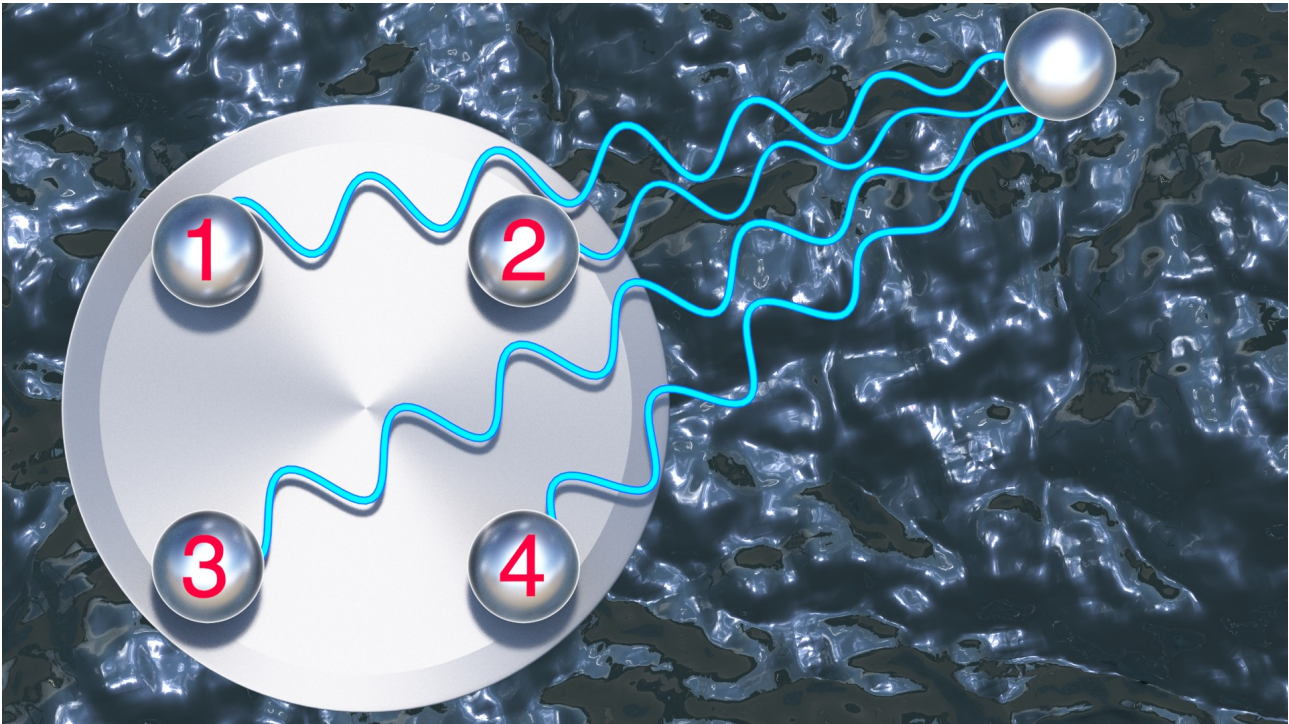
USBL is a system that uses acoustic sound waves to determine position underwater. A typical USBL set up consists of the USBL head unit containing an acoustic transceiver and a hydrophone array, and a transponder containing a transceiver. The USBL head unit can use range and approach angles to calculate the position of the transponder.

USBL stands for Ultra-short Baseline. For Subsonus this means that all hydrophones and transducers are contained in a single, compact unit that houses all the signal processing capability to determine an acoustic position.



*Illustration 1: Typical USBL positioning set up*

A typical USBL set up will have a USBL transceiver mounted on a pole attached to the side of a surface vessel or structure and another transceiver mounted on a vehicle underwater, see Illustration 1.



*Illustration 2: USBL hydrophones receiving acoustic sound waves from a transponder*

The way a USBL system works is that the USBL head unit, Subsonus, will transmit an acoustic sound wave signal. That acoustic signal travels through the water at the speed of sound and arrives at the transponder, Subsonus Tag, a short time later. The transponder receives the acoustic signal and replies with its own signal. The USBL head unit receives the response on each of its hydrophones, these are separated by a known distance, by comparing the acoustic signals time of arrival at each of the hydrophones it is possible to determine the direction the signal has come from, see Illustration 2. A comparison of the time at which the signal was transmitted and the time at which the signal was received, the amount of time the signal was travelling through the water can be determined. This travel time can be used to calculate the distance (range) between the USBL head and the transponder by using the speed of sound through water. With both distance and bearing, the relative position of the transmitter can be determined.

## **5.2 Orientation**

Orientation of a Subsonus Tag is provided by combining the output of accelerometers and magnetometers combined in a mathematical algorithm. Orientation consists of the three body angles roll, pitch and heading.

## **5.3 Sensor Co-ordinate Frame**

Inertial sensors have 3 different axes: X, Y and Z and these determine the directions around which angles and accelerations are measured. It is very important to align the axes correctly during installation otherwise the system won't work correctly. These axes are marked on the screen shown in Illustration 3 below with the X-axis pointing out of the screen, the Z-axis pointing down through the base of the unit and the Y-axis pointing off to the right.

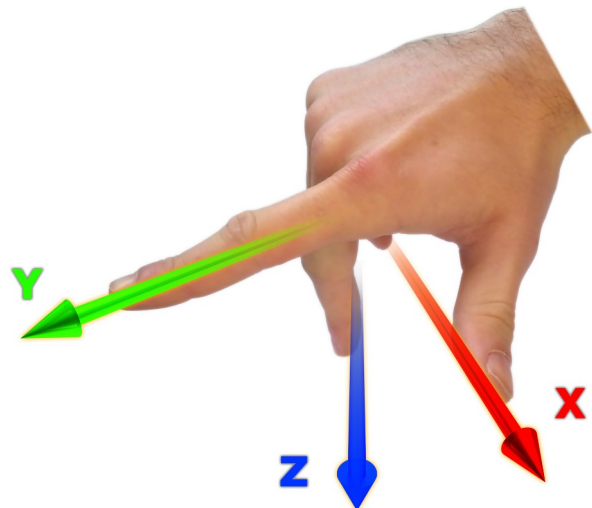


When installed in an application the X axis should be aligned such that it points forwards, with the screen facing forward, and the Z axis aligned so that it points down when level. A good way to remember the sensor axes is the right hand rule, which is visualised in Illustration 4. You take your right hand and extend your thumb, index and middle. Your thumb then denotes the Y axis, your index denotes the X axis and your middle denotes the Z axis.

### 5.4 Roll, Pitch and Heading

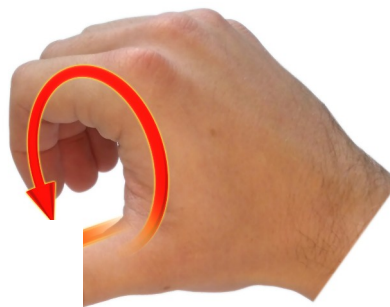
Orientation can be described by the three angles: Euler angles. The rotation axes of roll, pitch and heading are defined as follows. The arrow indicates the positive rotation direction.

Roll is the angle around the X axis and is zero when the unit is level. Heading is the angle around the Z axis and is zero when the positive X axis is pointing to true north.

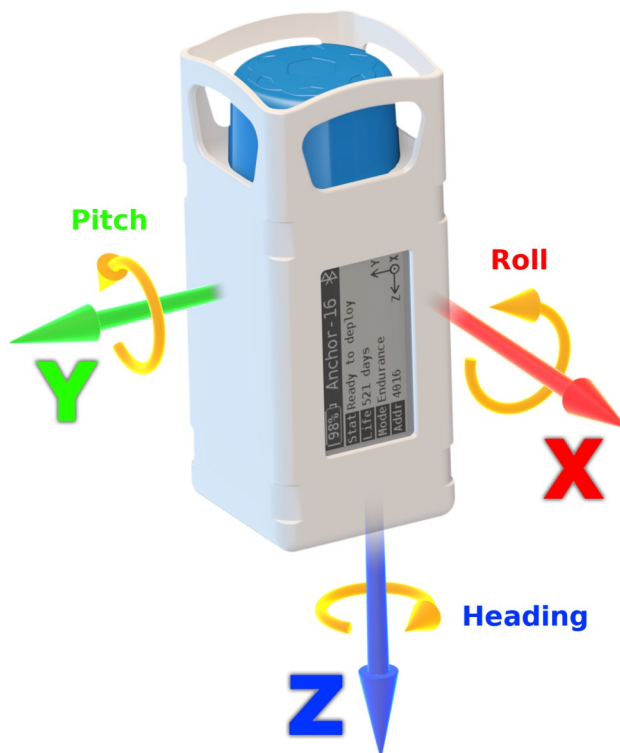


#### 5.4.1 Second Right Hand Rule

The two right hand rules are often the best way to describe rotation. The first right hand rule gives the positive rotation direction for that axis. The second right hand rule is used to determine the direction of rotation. To use it, point your thumb in the positive direction of the axis. Your fingers curl in the direction of positive rotation for that axis.



Hand Rule



In the final orientation the three rotations must be applied in the following order: heading, then pitch, and finally roll. To deduce the final orientation the unit is initially pointing north and the Z axis pointing down. Heading is applied first, then pitch, and finally roll is applied to give the final orientation. This process is often best learned experimentally by using the orientation plot in real time on the Tag.

Illustration 3: Subsonus Tag Axes



## **6 Evaluation Kit**

The Subsonus Tag Evaluation Kit contains everything required to start operating a system. This includes one Subsonus unit, one Subsonus Tag and the GNSS compass required for a moving vessel application.

The Subsonus Tag Evaluation Kit system can demonstrate the full positioning and orientation capabilities of the Subsonus Tag with the output navigation data referenced to a global coordinate frame. It is designed to allow customers to quickly set up the system and achieve maximum performance.

### **6.1 Evaluation Kit Contents**

1. 1x Subsonus with vertical connector, pre-loaded with surface configuration.
2. 1x Subsonus Tag.
3. 1x Qi charger.
4. 1x Qi charger power supply, with cable.
5. 1x Subsonus universal mounting bracket, see Subsonus Reference Manual.
6. 1x Subsonus connector to RJ45 connector 10 meter cable.
7. 2x 100-240V PoE (Power over Ethernet) power supply injector.
8. 2x 2 meter cat6 ethernet cables.
9. 1x High Accuracy PoE GNSS Compass (comes with cable).
10. 1x 4 port generic network router with DHCP server.
11. 1x Android handset for Bluetooth configuration.

### **6.2 Evaluation Kit Quick Start Guide**

1. Mount the Subsonus and Subsonus Tag following the mounting guidelines in the Subsonus Reference Manual and section 9.2 respectively. It is recommended to mount the surface Subsonus on a pole using the universal pole mount bracket included.
2. Plug the surface Subsonus cable into the output port on the PoE injector and then the PoE injector input port into the network router. When the PoE injector begins delivering power to Subsonus the LED indicator will change from orange to white.
3. Plug the Qi charger into its power supply, a LED indicator should indicate it is powered.
4. Place the Subsonus Tag onto the Qi charger, the screen on the Tag should face up, on the opposite side to the charger, see Illustration 10. The screen should update indicating the Tag has come out of shipping mode.
5. Install zeroconf (Apple Bonjour) from one of the links below:  
<https://www.advancednavigation.com.au/Bonjour.msi> (32-bit installer)  
<https://www.advancednavigation.com.au/Bonjour64.msi> (64-bit installer)
6. Open your web browser and type in the address <http://an-subsonus-1.local/> to connect to the Subsonus unit.



7. Navigate to the Surface Subsonus Unit's web interface. Open "Configuration" → "Filter Aiding", in "INS Selection" select the "Fixed Position" option.
8. The system is now ready for basic testing. Click on the "View" → "Status" page on the web interface of the Subsonus Unit to see the status. It may take a couple minutes to initialise after which time the location of the Subsonus and Tag units will appear on the "View" → "Main" page.



## 7 Part Numbers and Ordering Options

### 7.1 Subsonus Surface Kit

Part Number	Description	Notes
SUBSONUS-V	Subsonus with connector installed in vertical port.	Typically best choice for mounting Subsonus on a pole.
SS-10M-CABLE	Subsonus 10 meter RJ45 cable	Subsonus 10 meter cable, RJ45 Ethernet connector to MCIL8F connector with cap.
POE-INJECTOR	AC PoE Injector	100-240V AC PoE power injector adapter.
SUBSONUS-CASE	Plastic carrier case	Foam insert to hold Subsonus as well as accessories
SS-POLE-BRACKET	Subsonus Surface Pole Mount Bracket	Subsonus Surface Pole Mount Bracket, includes screws
CABLE-ETHER-2M	2 meter Ethernet cable	2M Cat6a Network Cable
ROUTER-4PORT	4 Port Ethernet Router	Network Router for Subsonus Kit with AC/DC adapter removed and replaced with universal AC/DC adapter
GC-POE-LC	GNSS Compass Low Cost Ethernet Variant	GNSS Compass Low Cost Ethernet Variant Power over Ethernet interface L1 only GNSS receiver Supports DGPS Supports post-processing (PPK)
GC-POE-CABLE-20M	20m Ethernet cable for GNSS Compass	20m CAT5e Ethernet cable with RJ45 Compatible with Ethernet units only (GC-POE-LC and GC-POE-HA) IP67 environmentally sealed connector

Table 4: Subsonus Surface Kit Part numbers

### 7.2 Subsonus Tag Kit

Part Number	Description	Notes
SUBSONUS-TAG	Subsonus Tag	Single Transponder, trackable by Subsonus
SUBSONUS-TAG-CHG	Qi Charging Pad and Power Supply	Qi compliant fast charging pad for Subsonus Tag charging with included power supply
SUBSONUS-TAG-CASE	Plastic carrier case	Foam insert to hold Subsonus Tag as well as charger

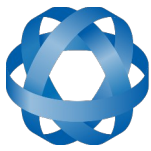
Table 5: Subsonus Tag Kit Part numbers



### 7.3 Accessories

Part Number	Description	Notes
ANDROID_HNDSET	Android Handset	Android handset (model varies)

*Table 6: Accessories part numbers*



## 8 Specifications

### 8.1 Mechanical Drawings

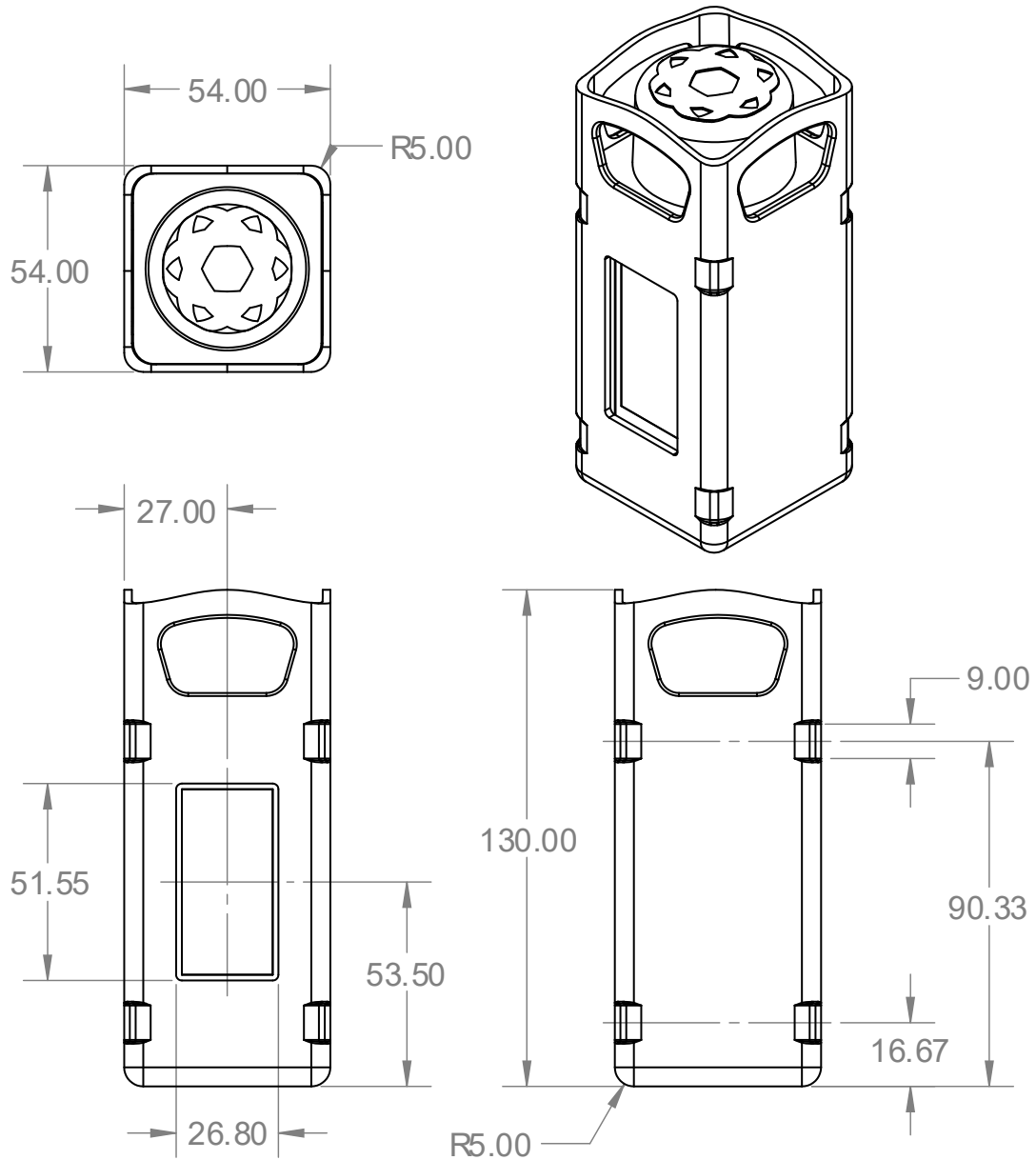


Illustration 6: Subsonus Tag mechanical drawings





### 8.1.1 Positioning with Subsonus USBL

Parameter	Value
Position Accuracy (5 m range)	0.25 m
Position Accuracy (100 m range)	1.5 m
Position Accuracy (1000 m range)	15.0 m

Table 7: Positioning specifications

### 8.2 Acoustics

Parameter	Value
Frequency	30 kHz (broadband)
Range	1000 m
Acoustic Coverage	Omnidirectional
Range Accuracy	0.02 m
Maximum Update Rate	1.3 Hz

Table 8: Acoustics specifications

### 8.3 Sensors

Parameter	Value
Roll & Pitch Accuracy	1.0 °
Heading Accuracy (Magnetic)	2.0 °
Water Temperature Accuracy	0.5 °C

Table 9: Sensors specifications

### 8.4 Display

Parameter	Value
Display Type	Pressure Tolerant Electronic Paper Display (EPD)
Size	54 mm
Resolution	122 x 250 Pixels
Display Daylight Visibility	Direct Sunlight

Table 10: Display specifications



## 8.5 Battery

Parameter	Value
Battery Capacity	28 Wh
Battery Life (5 second ping rate)	48 hours
Battery Life (1 ping/hour)	30 days
Battery Life (listening)	18 months
Charging	Qi Wireless Charging v1.2
Battery Recharge Time	6 hours

Table 11: Battery specification

## 8.6 Hardware

Parameter	Value
Interface	Bluetooth Low Energy v4.1
Depth Rating	2000 m
Operating Temperature	-5 °C to 50 °C
Storage Temperature	-20 °C to 60 °C
Shock Limit	40 g
Dimensions	52x52x125 mm
Weight in Air	550 g
Weight in Water	250 g

Table 12: Hardware specifications

## 8.7 Serial Number

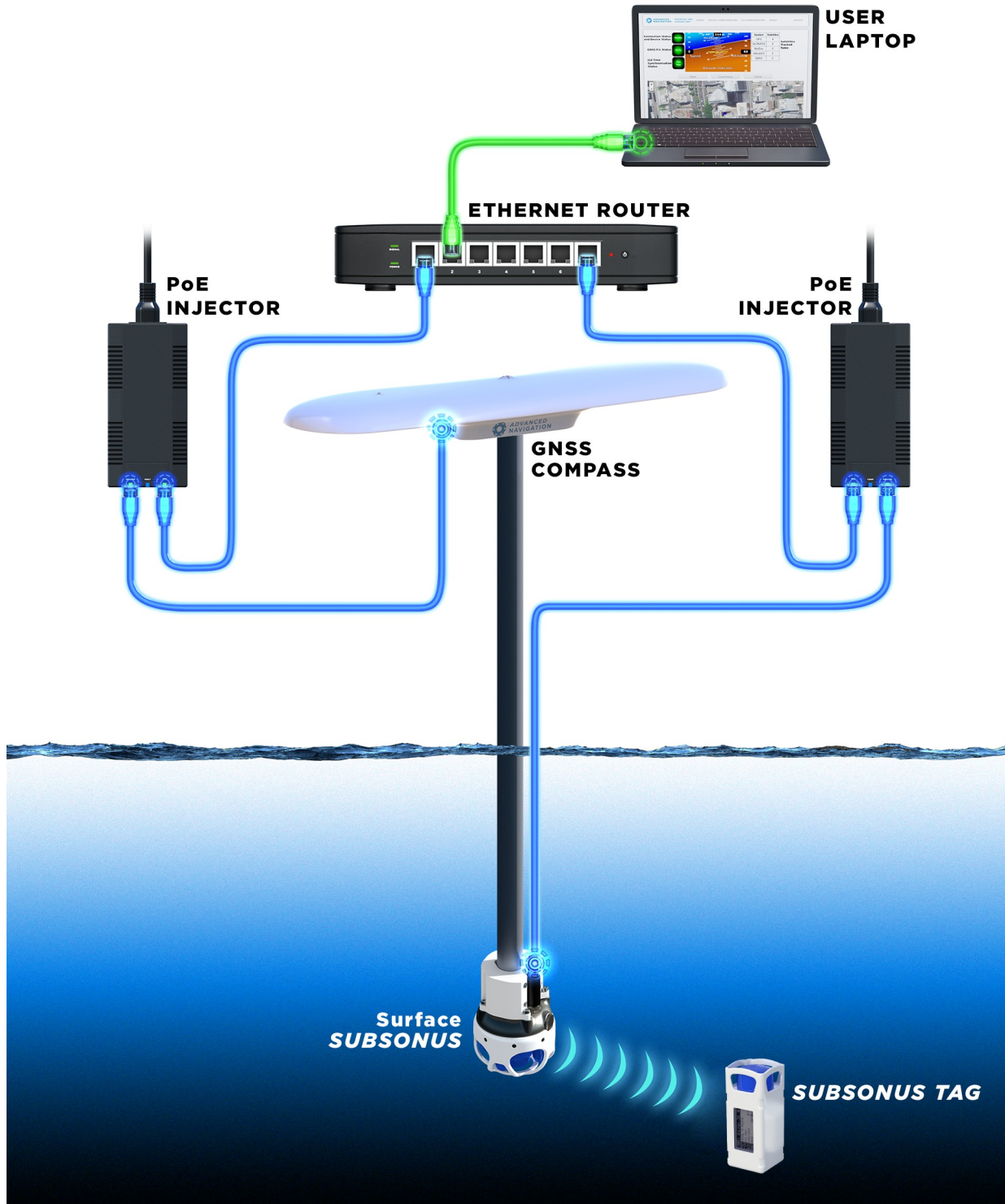
The serial number can be inspected by using the device information page in the Subsonus Tag Manager application, see section 11.7 . A label containing the information is located on the base of the plastic shell with the serial number encoded in a 2D data matrix bar code to assist customers in tracking their units. The external label also contains the hardware version and build date. Applications are available for most smart-phones that can scan the 2D data matrix bar code to display the serial number.



## **9 Installation**

### **9.1 Installation Check-list**

1. Charge the Tag to exit shipping mode.
2. Ensure that the Subsonus Tag has enough charge for the application.
3. Ensure that the Subsonus Tag is configured correctly for the application.
4. Mount the Subsonus Tag unit following the guidelines in section 9.2 .
5. Follow installation check-list section 9.1 in the Subsonus Reference Manual for set-up and installation of the Subsonus.
6. Deploy the Subsonus and Subsonus Tag
7. Wait until acoustic communication is established (may take a couple of minutes)
8. Configure the track rate for the Subsonus Tag required by the application, this is done from the Subsonus on the "Configuration" → "Devices" page
9. Watch the acoustic track in the Subsonus Main View and ensure there are no errors on the Status Indicator



*Illustration 7: Installation Setup Example*

## 9.2 Subsonus Tag Mounting



It is recommended to mount Subsonus tag on the top of a subsea vehicle or structure, pointing towards the surface, see Illustration 8. Note that any physical obstruction between the Subsonus and the Subsonus Tag will result in loss of positioning accuracy or failure to operate entirely.

Mounting goals with the Subsonus Tag are:

1. The Subsonus Tag should be mounted with the blue transducer pointing towards the Surface or tracking Subsonus. The screen should be facing forwards in relation to the direction of travel.
2. The Subsonus Tag should be mounted away from propellers and thrusters.
3. The Subsonus Tag should be mounted away from any air/gas exhausts. It should be mounted in a position where it will have minimal air bubbles passing over it.
4. The Subsonus Tag should be mounted as far away from large acoustically reflective surfaces, hard flat surfaces, as possible.
5. Care should be taken not to over-tighten the mounting restraints, as this may damage the Subsonus Tag. Cable ties are recommended for mounting, Tensile Strength: 50 lbs (22.68 kg), Width: 7 to 9 mm. Length > 250mm



*Illustration 8: Example Subsonus Tag Mounting*

### **9.3 Subsonus Tag Addresses**

It is possible to track multiple Subsonus Tags from a single surface Subsonus unit. If only one Subsonus Tag is to be tracked, this section can be disregarded as the factory default unit addresses will work out of the box.



### **9.3.1 Device Address Usage**

One Subsonus unit can track as many Targets as required (up to 16000), this comes at a compromise of interrogation frequency per device.

Every Subsonus or Subsonus Tag being operated within a 3km radius must have a unique address otherwise communication collisions will occur.

### **9.3.2 Automatic Address Assignment**

A Subsonus Tag assigned an address of 0 (default) will automatically be assigned an address by the first Subsonus that discovers it acoustically.

Subsonus will assign addresses sequentially from its list of known devices.

### **9.3.3 Manual Address Assignment**

When tracking more than one subsea Subsonus or Subsonus Tag, each units address should be set to a unique value. This can be set on Subsonus Tag via the App, see section 11.9 . Typically this will be a numerically ascending value from 2 i.e. 2, 3, 4, 5 and so on.

Addresses in the range 256 to 699 are reserved and cannot be used.



## 10 Operation

### 10.1 Initialisation

Subsonus Tag is shipped from the factory in “Shipping Mode”. In this state the unit is completely inactivated. Place the tag on an approved Qi charger to return the device to the default Performance mode.

### 10.2 Electronic Paper Display

Subsonus Tag contains an electronic paper display (screen), this technology allows very low power information display and the contents of the screen persists when the device is not powering the screen directly, this means the screen will hold the last programmed image, without drawing power, indefinitely.

The screen displays configuration and status of the Subsonus Tag, this information includes

1. Battery Charge
2. Display Name
3. Bluetooth Status
4. Status Summary
5. Battery Life/Charge Estimation
6. Operation Mode
7. Device Address
8. Orientation Axis

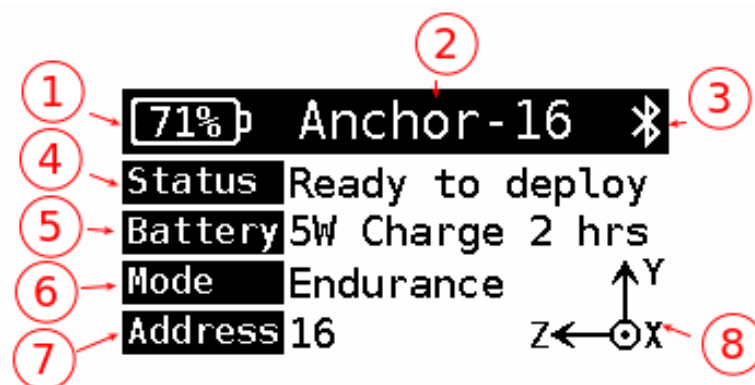


Illustration 9: Electronic Paper Display Screen

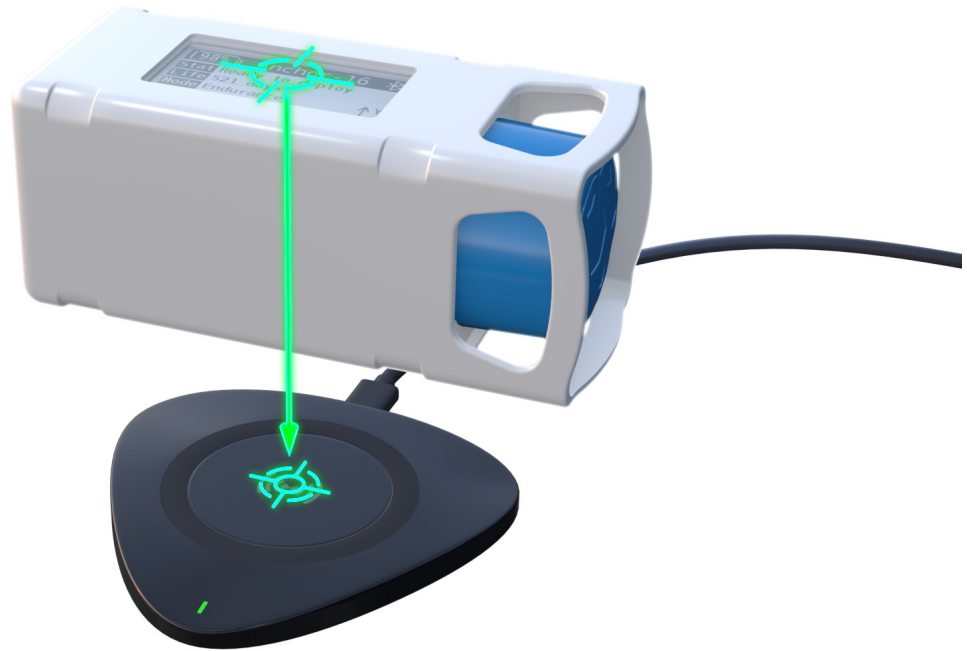
### 10.3 Qi Charging

Qi (pronounced Chee) is an open wireless charging standard that uses resonant inductive coupling to transfer power. This is the standard used by mobile phones and is readily available. Subsonus Tag is compatible with most standard Qi chargers.



### **10.3.1 Qi Charger Alignment**

Subsonus Tag must be placed on a charging pad with the screen facing up and the centre of the charging pad in line with the centre of the screen, see Illustration 10.



*Illustration 10: Subsonus Tag Charger Alignment*

When charging Subsonus Tag will turn on its backlight. This will then fade between two brightnesses. It may take a few seconds to start charging, once placed on the charging pad.

Care should be taken to ensure the Subsonus Tag remains centred on the charger, especially when charging on a moving vessel.

### **10.3.2 Qi Charging Rate**

Subsonus Tag can fully charge in 6 hours when charged with the 5 Watt charger. There are conditions that will cause Subsonus Tag to charge at a lower rate, such as high Tag temperature, misalignment of the coil, or insufficient power available from the charger. Subsonus Tag will display the charging rate as well as the estimated charge time on its screen, see Illustration 11.



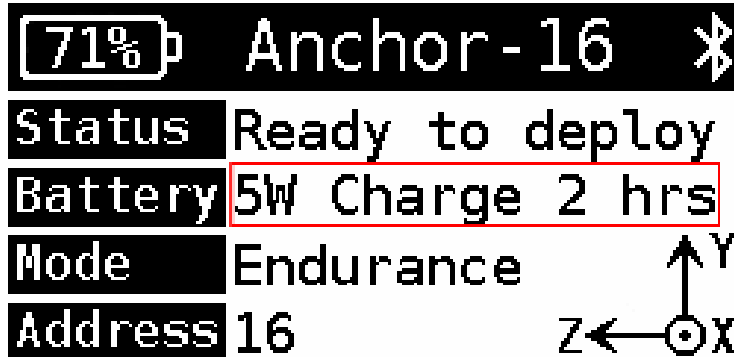


Illustration 11: 5W Charge with Time Estimate

### 10.3.3 Qi Charger Power Supply

The supplied Qi charger cannot provide full charge rate unless powered by an appropriate power supply, such as the one provided. A laptop USB port is not suitable and will only be capable of charge Subsonus Tag at a maximum 1W, drastically increasing charge time.

### 10.4 Bluetooth

Subsonus Tag contains a Bluetooth low energy radio module and can be connected to and configured via this interface.

Note that Bluetooth communication will not work when the Subsonus Tag is underwater.

#### 10.4.1 Bluetooth Discovery

Subsonus Tag will be discoverable via Bluetooth when charging and for a short period of time after removed from charge. When discoverable the Bluetooth symbol is displayed on the screen, see Illustration 12.

Subsonus Tag is not discoverable when connected to another Bluetooth device

If Subsonus Tag is not displaying the Bluetooth symbol, see Illustration 14, in this case charging is required to re-enable Bluetooth discovery.

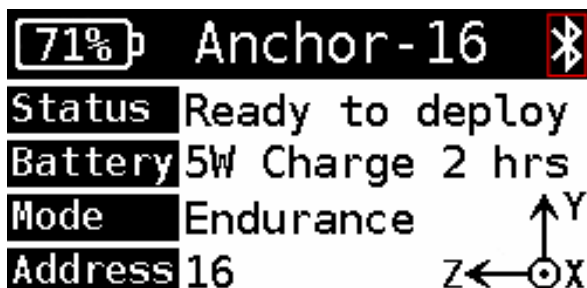


Illustration 12: Bluetooth Discoverable

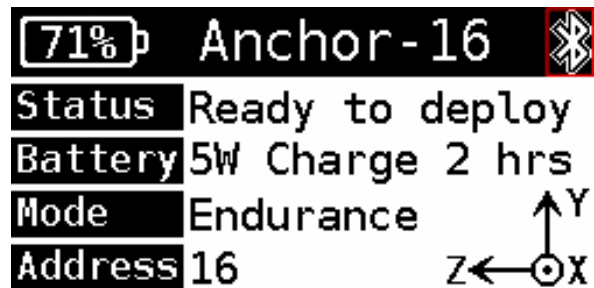


Illustration 13: Bluetooth Connected

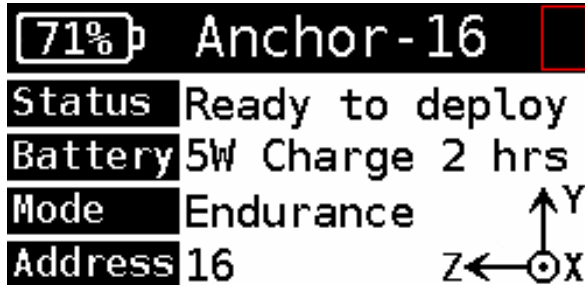


Illustration 14: Bluetooth Not Discoverable

### 10.4.2 Bluetooth Connection

When a Bluetooth device is connected to Subsonus Tag, it can be configured and have its status read back by the connected device. When Bluetooth is connected the Subsonus Tag screen will display a highlighted Bluetooth symbol, see Illustration 13.

### 10.5 Firmware Update

During a Subsonus Tag firmware update the screen will display firmware update information. This screen will not change until a new firmware is successfully loaded onto the device.



Illustration 15: Firmware updating screen

### 10.6 Shipping Mode

When Subsonus Tag is sent to shipping mode the screen will display a fixed shipping mode logo as well as shipping information.



Illustration 16: shipping mode screen



## 10.7 Battery

Subsonus Tag contains a 28 Wh battery. At full charge this allows the device to operate for up to 18 months in low power mode.

The battery requires charging when depleted. A full charge at the maximum charge rate takes 6 hours assuming a 5 Watt charge rate is maintained throughout.

The Battery state of charge is displayed on the screen, see Illustration 9 marked number 1.

The estimated charge time, at the current charge rate, is displayed on the screen when charging, see Illustration 11.

### 10.7.1 Storage

For Subsonus Tag storage longer than 30 days:

- Ideally, Subsonus Tag should be stored out of direct sunlight and at between 10 and 27 degrees Celsius.
- Store the device with the battery in a charged condition (at least 30% to 50% charged)
- Subsonus Tag should be placed in "Shipping Mode"

### 10.7.2 Environmental Protection



Recycle raw materials instead of disposing as waste. Please recycle where facilities exist. Check with your local authority or retailer for recycling advice.

### Warning:

Do not attempt to destroy or disassemble device or remove any of its components. Batteries must be recycled or disposed of properly. Failure to comply with these warnings could result in fire and/or serious injury.

## 10.8 Operating Mode

Subsonus Tag can be placed in two operation modes depending on the application.

### 10.8.1 Performance Mode

When operating in Performance Mode:

- Acoustic interrogations are continuously monitored
- All sensors are running
- The battery is depleted faster, around 24 hours of tracking at 1Hz acoustic interrogation interval

This mode should be used for any job where the Subsonus Tag is retrieved after tracking, i.e. ROV tracking, Diver tracking, etc.



### **10.8.2 Endurance Mode**

When operating in Endurance Mode:

- Acoustic interrogations require a wake signal, this is less sensitive, to acoustic interrogations, than the continuous listening mode.
- Sensors are off and only sampled when replying
- Battery life is extended, up to 18 months with minimal interrogations

In this mode Subsonus Tag can be deployed, tracked briefly during deployment then left for months and retrieved at a later date.

Endurance Mode is less sensitive than Performance Mode and should not be used unless actually required for the application.

Note: If operating in an environment that has acoustic interference that wakes the device erroneously the battery life may be reduced.

## **10.9 Acoustic Data Protocol**

The user may select the acoustic data protocol used by Subsonus during tracking operations of Subsonus Tag. The data protocol is selected in the “Configuration” → “Tracking” page. By default the data protocol is set to “Auto”, in this mode Subsonus will automatically select the optimal data protocol based on the acoustic conditions. The user may select between “High Speed” mode or “High Reliability” mode.

“High Speed” is the standard acoustic protocol historically used by Subsonus Tag. In standard acoustic conditions it offers very high data transfer rates and a high level of resilience to acoustic noise and multipath.

“High Reliability” is an acoustic protocol optimised to allow Subsonus Tag to function in difficult acoustic conditions, such as where there is high background noise, or high levels of acoustic multipath. When operating in this mode the level of data being transmitted between units is decreased.

### **10.10 Data sources**

Subsonus Tag contains a number of sensors and functionality that can be accessed during operation.

#### **10.10.1 Orientation**

Subsonus Tag calculates an instantaneous orientation by use of magnetometers and accelerometers, this orientation is accessible via acoustics on a Subsonus or via Bluetooth.

#### **10.10.2 Magnetic Heading**

Subsonus Tag calculates heading using built-in magnetometers. The heading is thus susceptible to magnetic interference by external sources.

In the event that the Subsonus Tag is mounted in the presence of a strong magnetic interference source (such as close to a motor or high current wiring) or will be operating in the vicinity of large ferrous materials that can distort the local magnetic field, magnetic heading error may fall outside the specified range.



Magnetic Heading is accessible in service via the tracking Subsonus, or via Bluetooth at the surface.

## **10.11 Environmental Exposure**

### **10.11.1 Temperature**

Subsonus Tag should not be subjected to temperatures outside of its operating range. If the temperature rises above 65 degrees Celsius or below -20 degrees Celsius, Subsonus Tag will disconnect power to all systems and the warranty will be void – this state will be displayed on the screen. This state is not recoverable until the device is brought back into its safe operational range and placed on charge. Prolonged exposure to high temperatures can cause permanent damage to the battery and may completely disable the device. Avoid leaving Subsonus Tag in direct sunlight in hot climates.

### **10.11.2 Chemical**

Exposure to certain chemicals can damage Subsonus Tag and potentially disable the device. Subsonus Tag is designed to operate in fresh and salt water environments that are not contaminated with chemicals that can damage polyurethanes.

Please contact our Application Support Team ([support@advancednavigation.com](mailto:support@advancednavigation.com)) if the application under consideration is outside these parameters.

### **10.11.3 Shocks**

Subsonus Tag can tolerate shocks up to 40 g without disabling the device. Repeated exposure to shock up to this level will likely cause permanent failure. Dropping a Subsonus Tag from a height of 1.5 meters onto a hard surface may crack the crossbar of the housing around the transducer but is unlikely to disable the device.

### **10.11.4 Mounting Stress**

Over compression of the housing during mounting can cause damage to internal components and compromise the environmental sealing of the device. The deployed mounting solution should ensure adequate rigidity without introducing significant internal stresses into the device. High compression mounting clamps should be avoided when applying compression to the device to limit damage.



## 11 Subsonus Tag Manager

Subsonus Tag Manager is a software application provided by Advanced Navigation for configuration of the Subsonus Tag. The Subsonus Tag Manager application is available for Android via the Google Play Store.

### 11.1 Software Changelog

Version	Date	Changes
1.3	17/12/2019	Loading configuration files now supported User interface improvements Reduce power usage
1.2	06/08/2019	Packaged Subsonus Tag Firmware update
1.1	05/03/2019	Added magnetic calibration, section 11.13 Moved Shipping mode to main menu, section 11.12 Added log download for support, section 11.14.4
1.0	10/01/2019	Release version

Table 13: Subsonus Tag Manager software changelog

### 11.2 System Requirements

Subsonus Tag Manager uses Bluetooth 4.1 to communicate with the Tag. The Android device must contain a compatible Bluetooth radio. The minimum Android version for the application is V5.0 (Lollipop), supporting android SDK version 21

### 11.3 Installation

To install the Subsonus Tag Manager Application open the “Google Play Store” link on your android device.

1. Search for “Subsonus Tag Manager” and select the application by “Advanced Navigation”
2. Click the “Install” button
3. Once installed, open the App
4. Authenticate Bluetooth by pressing the “Authenticate” Button then select “Allow”

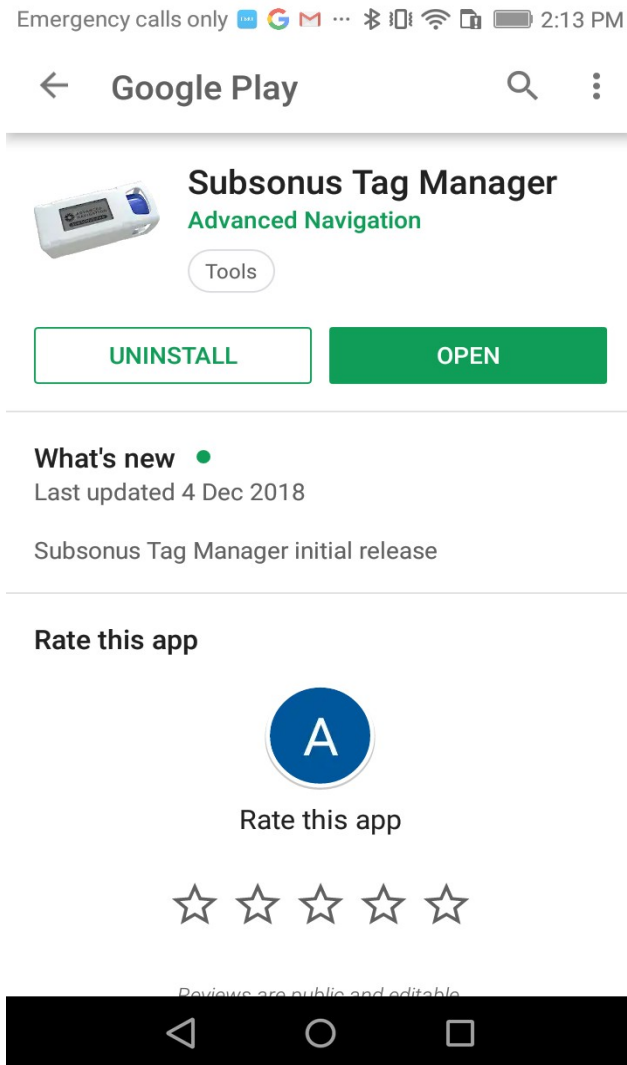


Illustration 17: Download from Google Play Store

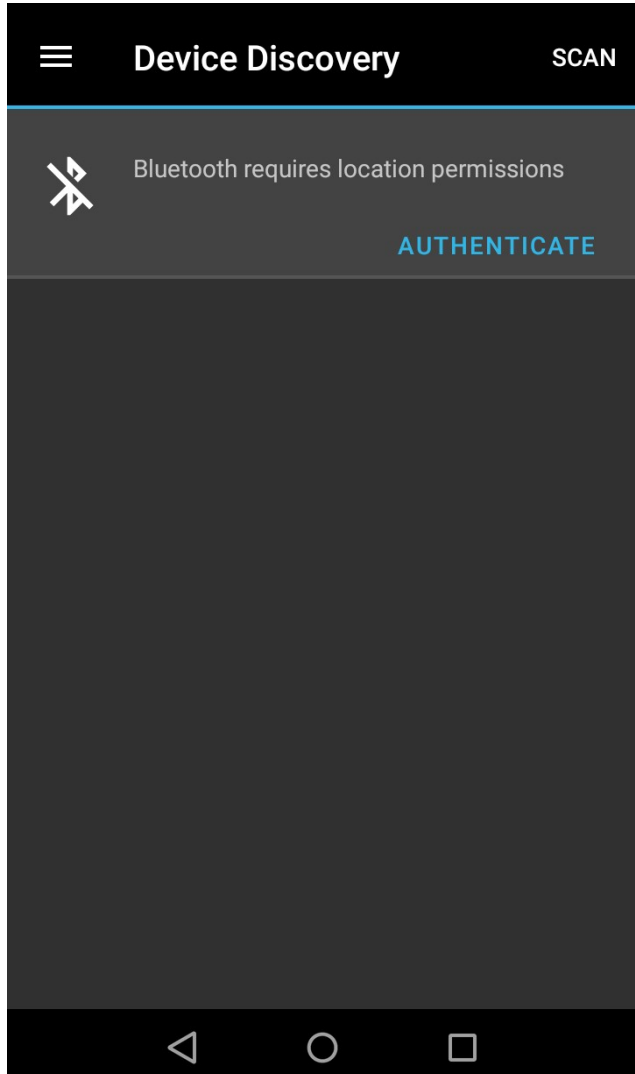
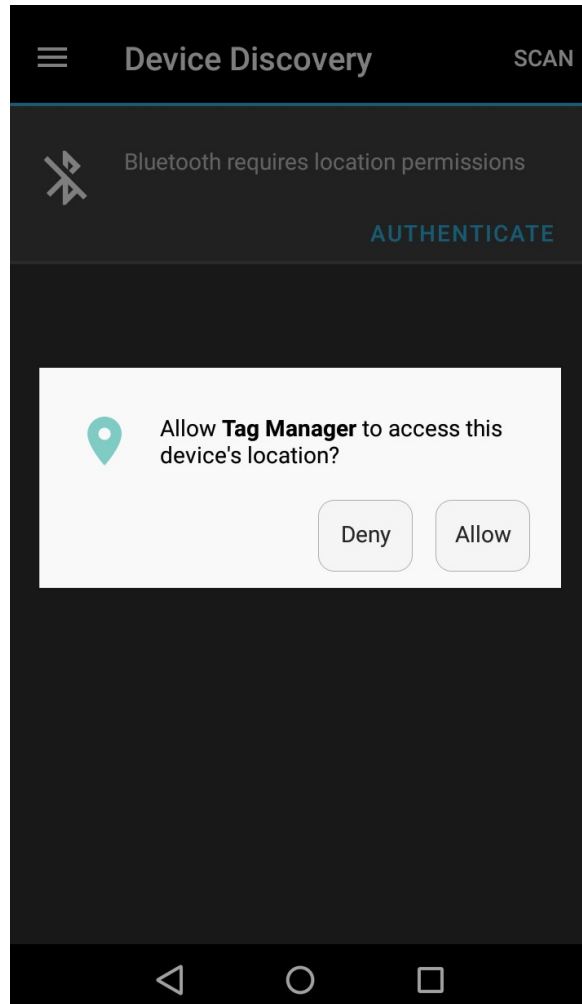


Illustration 18: Bluetooth permission request



*Illustration 19: Allow pop-up*

## 11.4 Tag Discovery

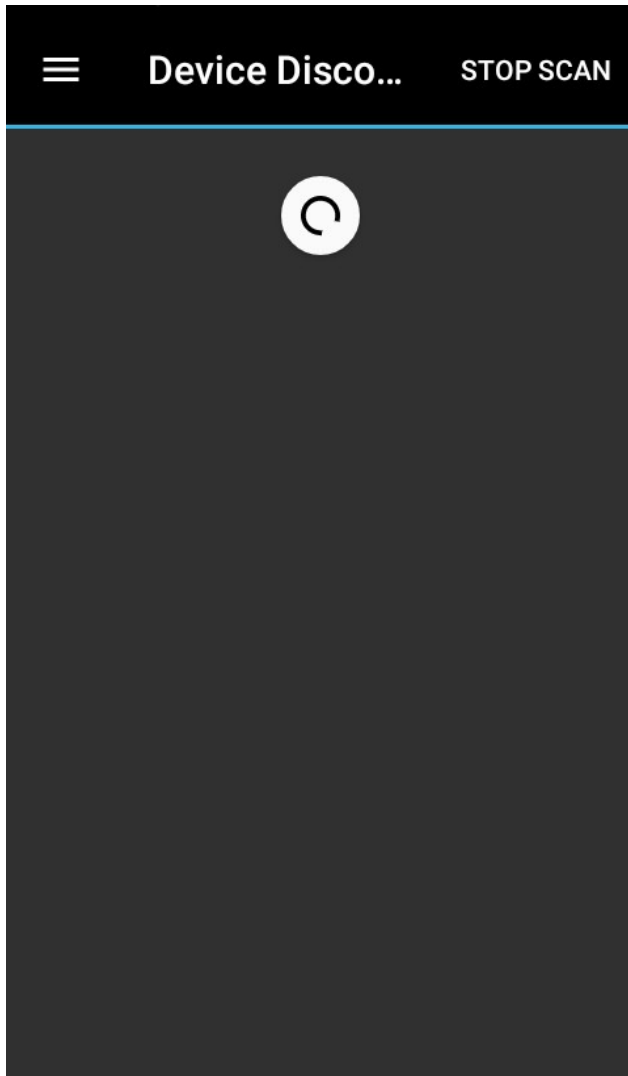
To connect to a Bluetooth device it must first be discovered. The Tag Manager application will run Bluetooth Discovery when on the Device Discovery Page. If the automatic Bluetooth Discovery was unsuccessful it can be re-run by pressing the "Scan" button.

When running discovery a circular loading symbol is displayed, see Illustration 20.

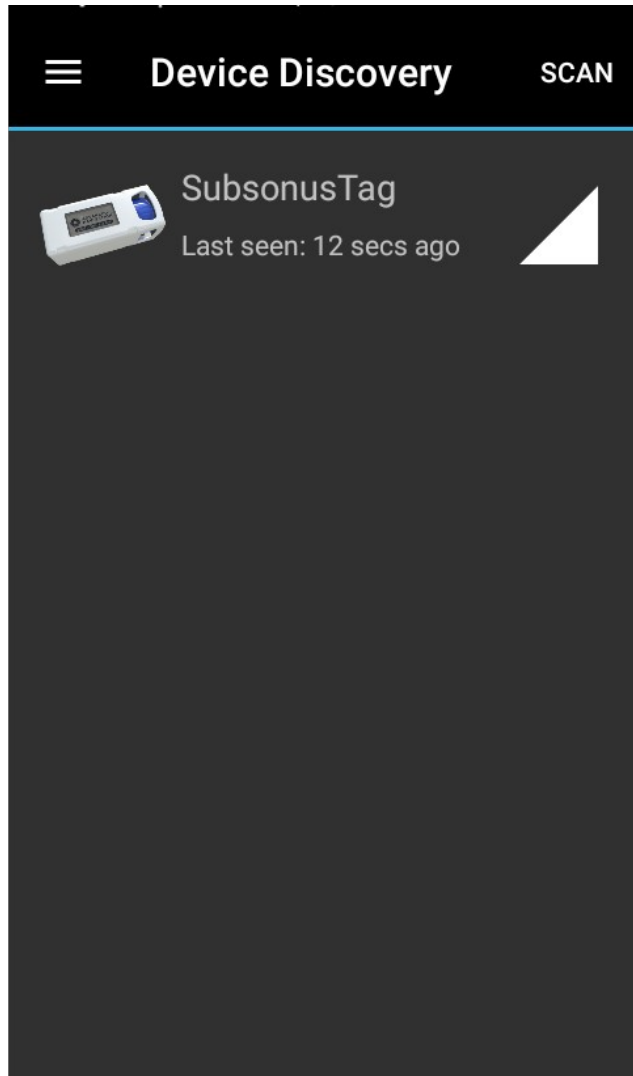
When a Tag has been discovered it will appear in the Discovered Devices list. The Subsonus Tag name, last discovered time and signal strength are all displayed, see Illustration 21.

To connect to a Tag, tap the image of the tag in the list.





*Illustration 20: Bluetooth Discovery Running*



*Illustration 21: Discovered Subsonus Tag*

Subsonus Tag will not be discoverable via Bluetooth if it is in “Shipping Mode” or if the Bluetooth symbol is not visible on the screen, see Illustration 12. In the event that Tag cannot be contacted, place the Tag on charge to activate Bluetooth.

Once a connection is established the Bluetooth Symbol on the Tag’s screen will be highlighted, see Illustration 13.

Subsonus Tag cannot be discovered or connected to if the Bluetooth connection is held by another device.

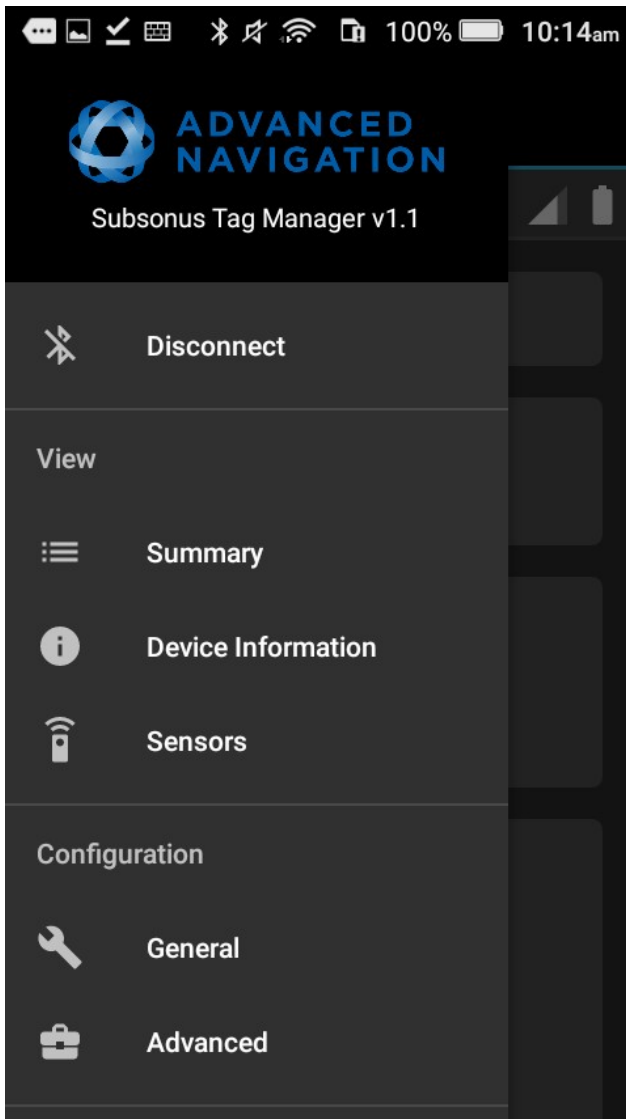
## **11.5 Menu**

To navigate to a page on the Tag Manager application press the “Menu” button in the top left corner of the screen.

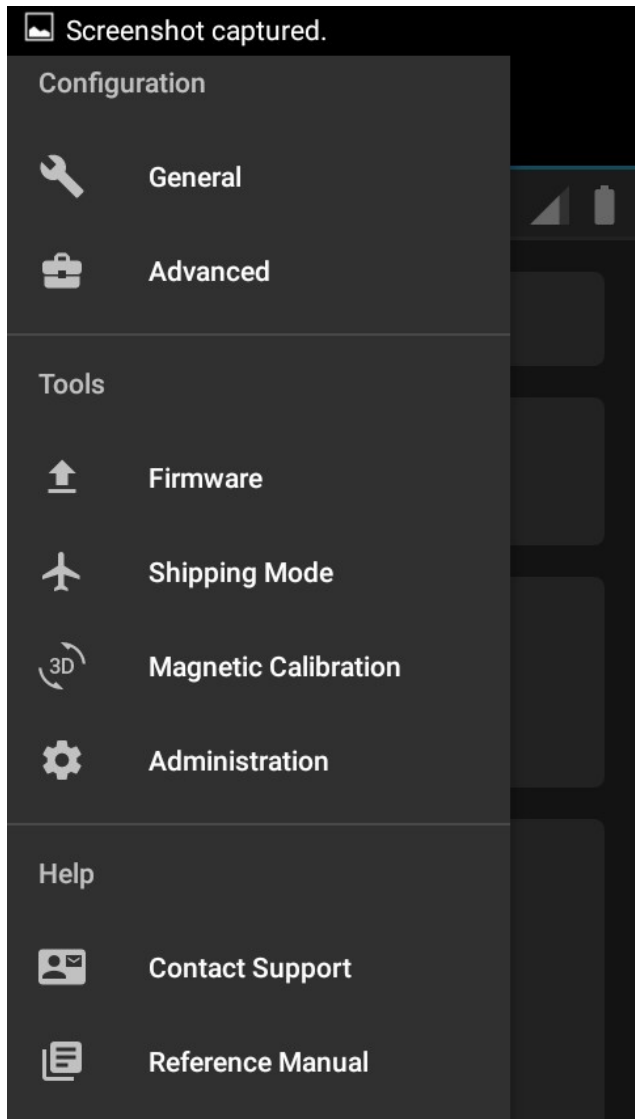


*Illustration 22: Menu Button*

This will open a navigation menu containing links to each available page. On the menu tap the page name to navigate to the page. To scroll down on the menu touch and drag the menu.



*Illustration 23: Menu top*



*Illustration 24: Menu Bottom*

Note: not all pages are available at all times, for example the application must be connected to a tag before the configuration pages become available.



## 11.6 Summary

When first connected to a Tag the Summary page will be displayed. This page displays the current state of the Tag as well as any problems.

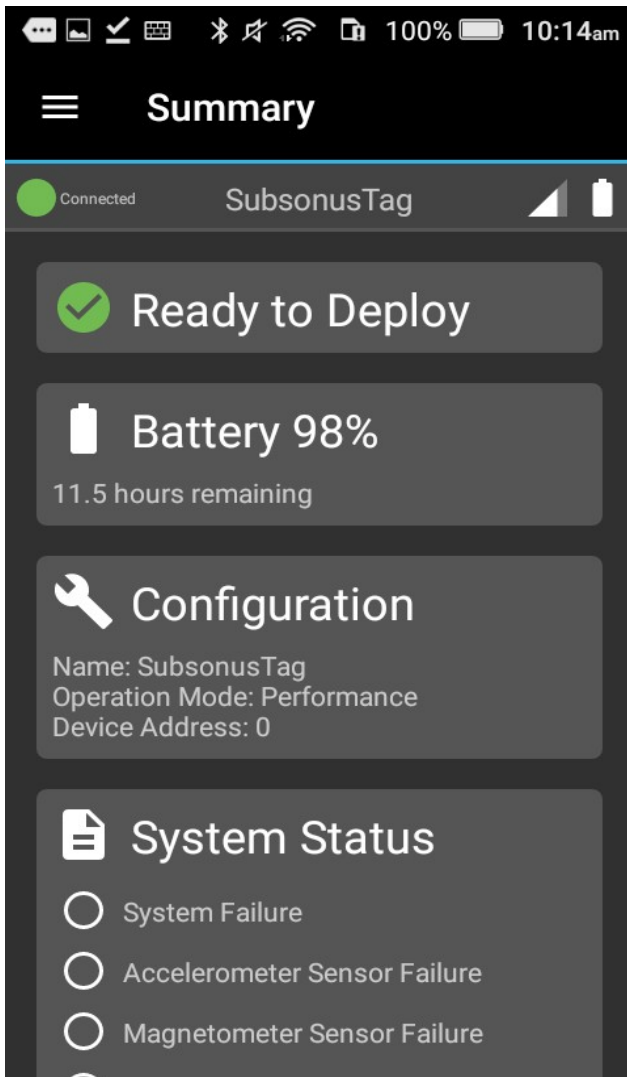


Illustration 25: Summary Page, top

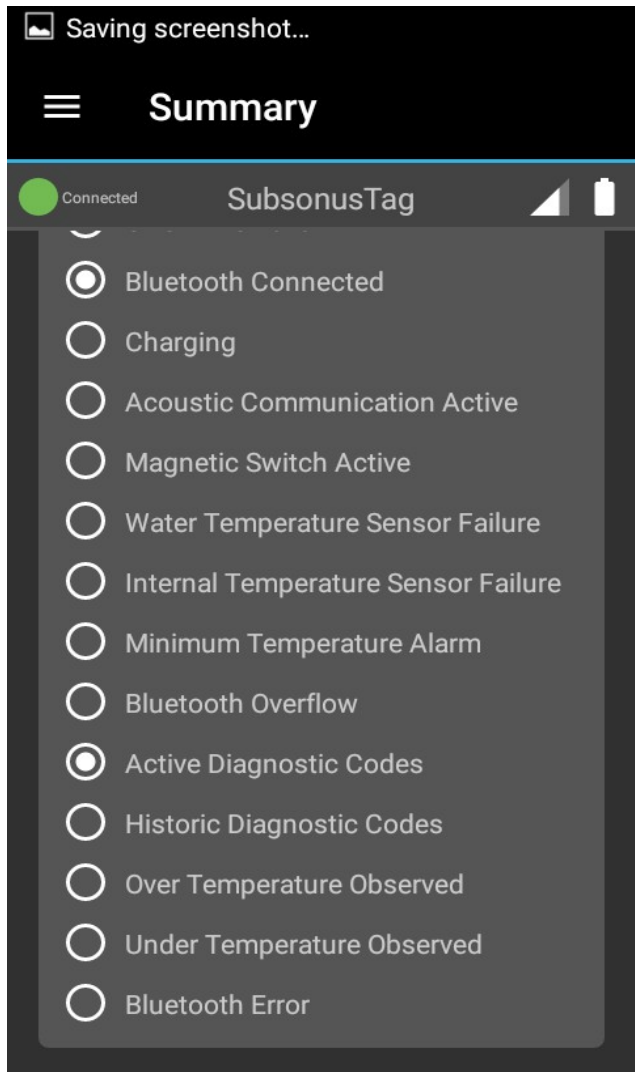


Illustration 26: Summary Page, bottom

### 11.6.1 Status

The status field displays any problems detected with the system. If no problems are detected the green tick and “Ready to Deploy” is displayed, see Illustration 27.

If a problem is detected the symbol changes and the error detected is displayed, see Illustration 28.



**Ready to Deploy**

*Illustration 27: Ready To Deploy*



**Not Ready To Deploy**

Heading Range Error

*Illustration 28: Problem Detected*

### 11.6.2 Battery

The battery field displays the state of charge of the battery in Subsonus Tag as well as estimated run time or charge time when charging.

When in performance mode the estimated run time is for maximum interrogation rate, meaning the battery life can be extended by dropping the interrogation rate.

When in endurance mode the estimated time is based on no interrogations occurring, each interrogation will reduce the expected battery life when in endurance mode.



**Battery 84%**

1 day 9 hrs remaining

*Illustration 29: Performance Mode Battery Life Estimate*



**Battery 84%**

Charging: 3.1W, 1 hr 26 mins until full

*Illustration 30: Charge Rate and Time Remaining*



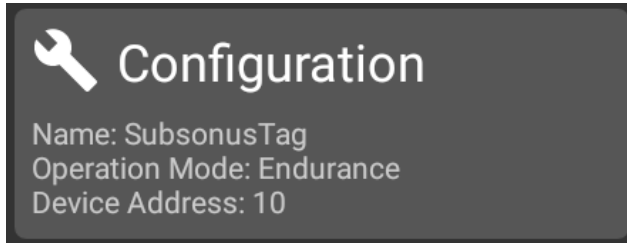
**Battery 84%**

378 days remaining

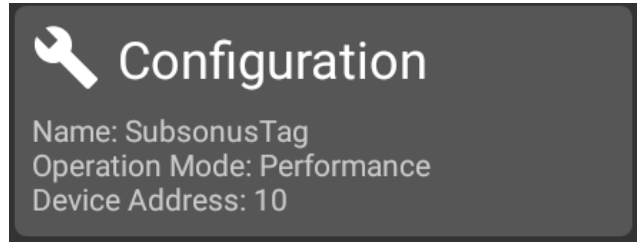
*Illustration 31: Endurance Mode Battery Life Estimate*

### 11.6.3 Configuration

Configuration displays the currently operating configuration of the Tag, including Display Name, Operation Mode and Device Address.



*Illustration 32: Configuration Display, Endurance Mode*

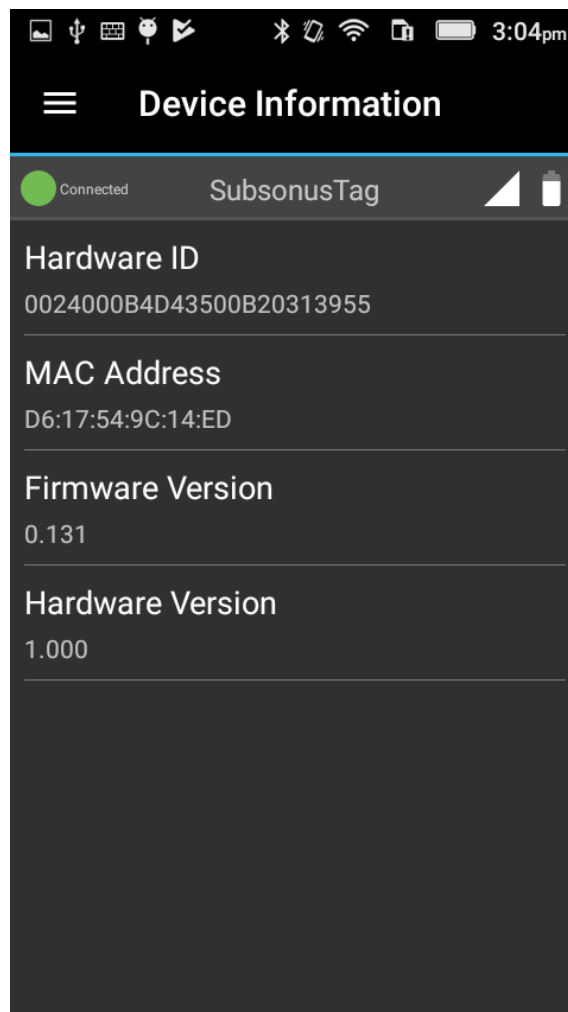


*Illustration 33: Configuration Display, Performance Mode*

#### 11.6.4 System Status

System status displays a detailed view of the status flags. These flags indicated problems with the unit and the state of various sensors.

#### 11.7 Device Information



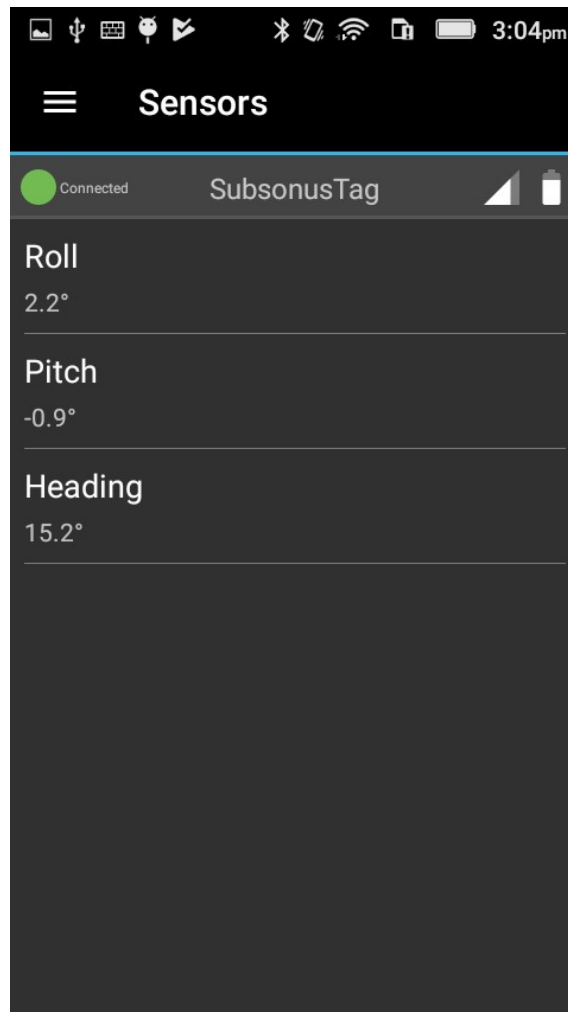
*Illustration 34: Device Information*



The device information page contains information on the device and hardware. This includes the hardware version, firmware version, Bluetooth MAC Address and the unique serial number of the device. See Illustration 34.

## 11.8 Sensors

The Sensors page shows the live readings of sensors on the Tag, these values are not configurable. See Illustration 35.

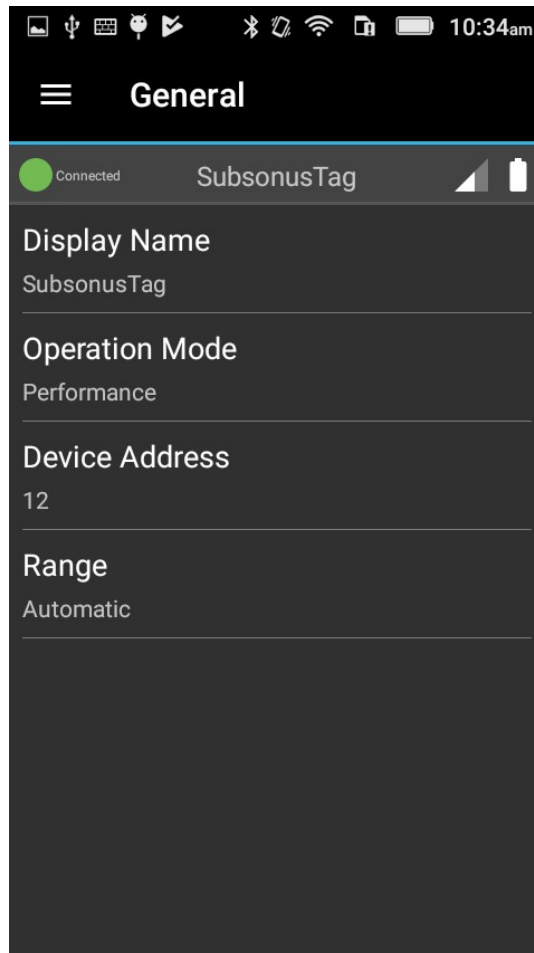


*Illustration 35: Sensors Page*



## 11.9 General

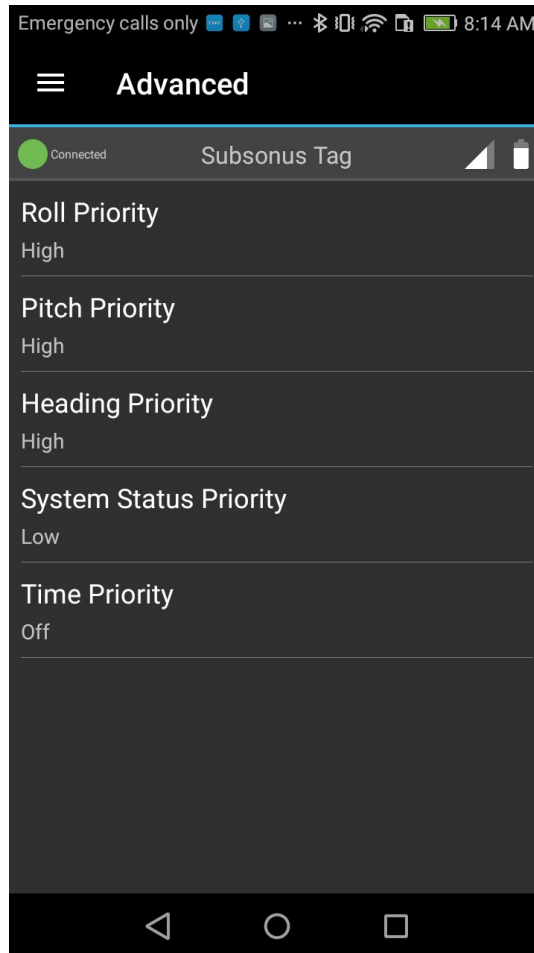
The general settings page allows the user to configure the device Display Name, Operation Mode, Device Address and Range. See Illustration 36.



*Illustration 36: General Configuration Page*

## 11.10 Advanced

The advanced page allows the user to configure the Acoustic Data Priority for Subsonus Tag. See Illustration 37.

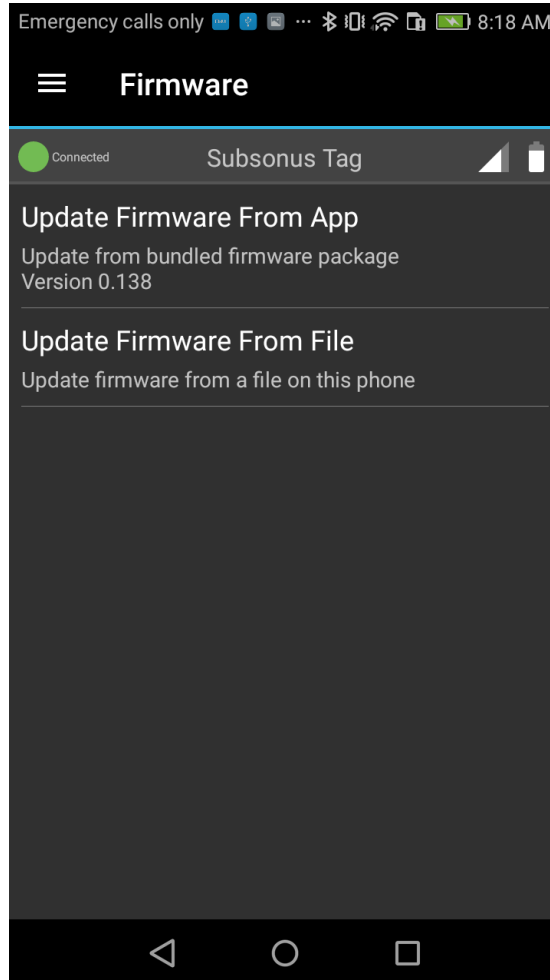


*Illustration 37: Advanced Page*

### **11.11 Firmware**

The firmware page allows the user to update the firmware on Subsonus Tag. Firmware can be updated from the version packaged in the App or from a file on the Android phone.





*Illustration 38: Firmware Update Page*

### **11.11.1 Packaged Firmware**

To update firmware from the version packaged in the App:

1. Press the “Update Firmware From App” button
2. Confirm the firmware version is the desired version
3. Press the “OK” button
4. Wait until tag has been updated, keep the phone and Tag in close proximity during the update.

### **11.11.2 Firmware from file**

Firmware can be loaded onto the android devices file system from a computer or direct download from a web page. A firmware file downloaded in this method can be uploaded to the Tag:

1. Load the desired firmware onto the Android device, take note of the location in the file system
2. Press the “Update Firmware From File” button



3. Navigate the file system to the firmware file location
4. Tap the firmware file, the App will display a confirmation page
5. Tap "OK"
6. Wait until tag has been updated, keep the phone and Tag in close proximity during the update.

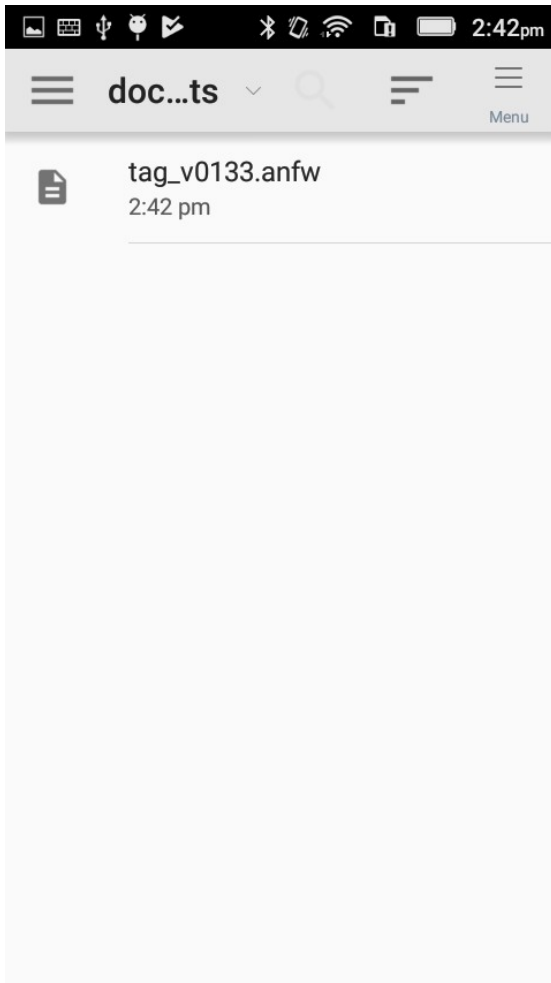


Illustration 39: File Select from File system

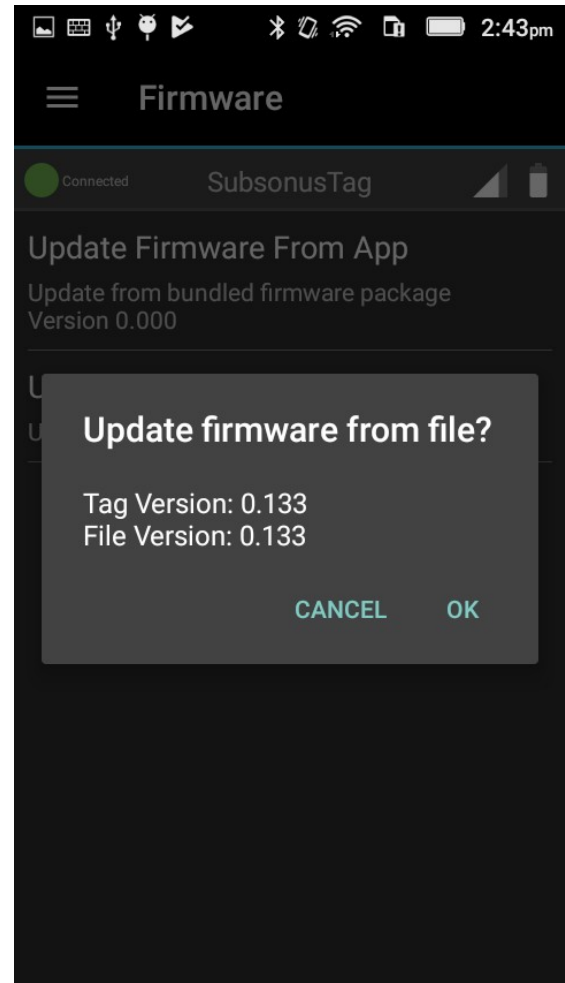
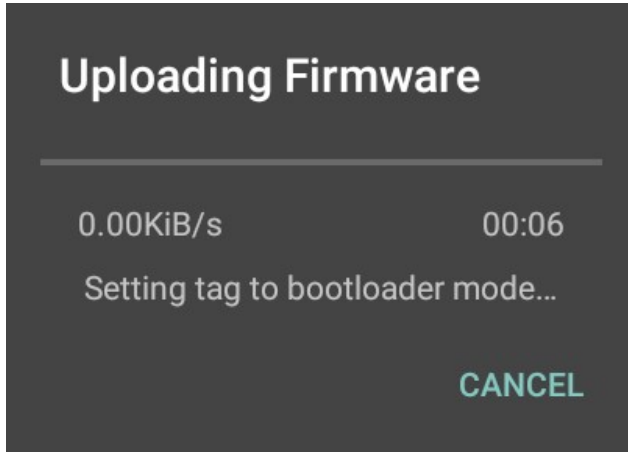
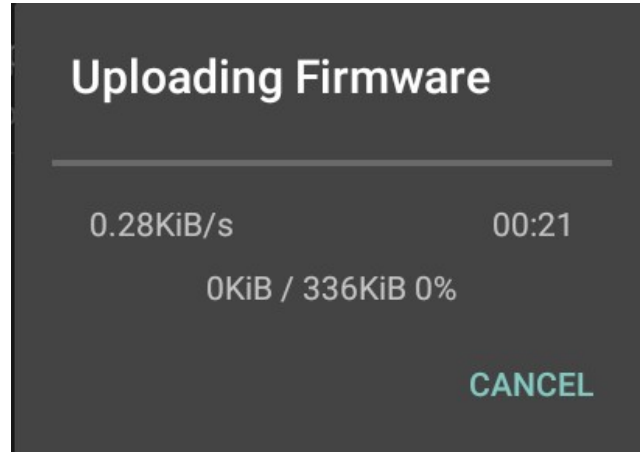


Illustration 40: Confirm Firmware upload from file



*Illustration 41: Setting Tag to Bootloader*



*Illustration 42: Uploading Firmware*

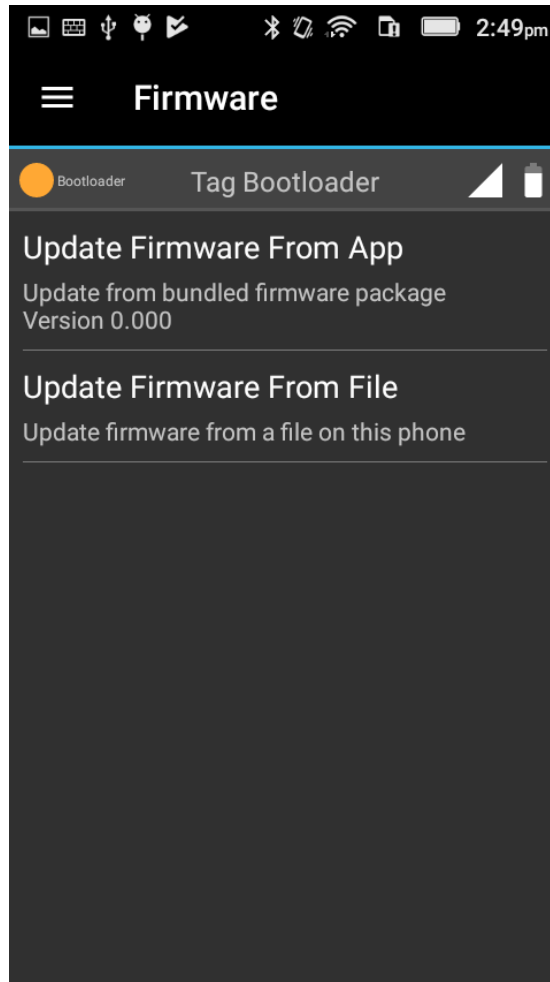
### **11.11.3 Bootloader**

To update firmware Subsonus Tag enters “Bootloader” mode. In this mode no functionality is available aside from firmware update. Bootloader is indicated by an Orange “Bootloader” indicator, the Tag’s display name will become “Tag Bootloader” when in this mode. See Illustration 43.

Subsonus Tag cannot be deployed in Bootloader mode and will not be trackable by a Subsonus.

When in Bootloader mode the screen on the Subsonus Tag will not update.

A Subsonus Tag in Bootloader mode will be listed as “Bootloader” in the Bluetooth Discovery List.



*Illustration 43: Bootloader Indicator*

#### **11.11.4 Firmware Upload failure**

In the event that a Firmware upload fails or is cancelled the Subsonus Tag will remain in Bootloader and firmware upload can be re-tried.

#### **11.12 Shipping Mode**

The behaviour of the control is identical to section 11.14.1 .

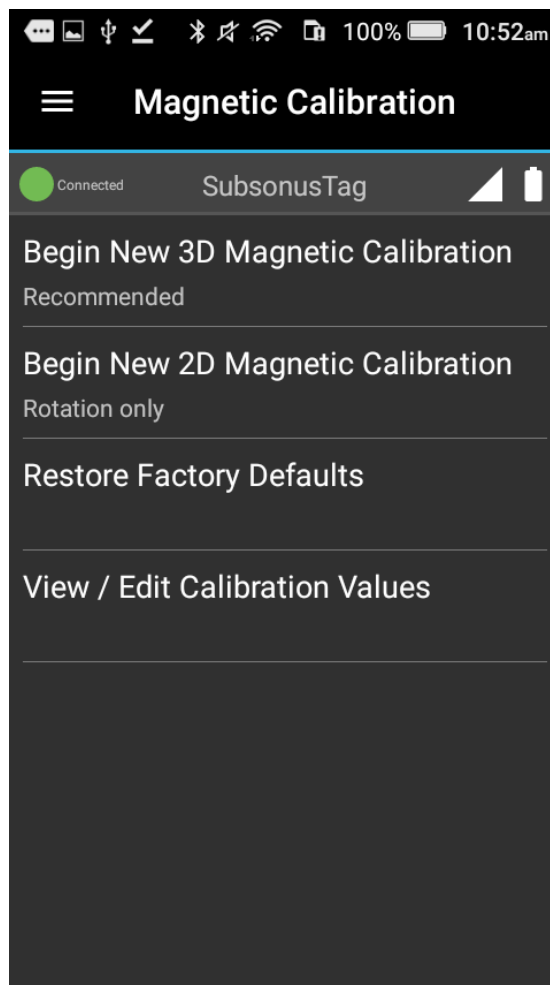
#### **11.13 Magnetic Calibration**

The Magnetic Calibration page (See Illustration 44) gives users the ability to manage Subsonus Tag's magnetic calibration. This is crucial for accurate heading.

3D calibration involves rotating through all orientations and is designed for vehicles that can easily and safely be rotated upside down, such as small ROVs. 3D calibration offers slightly better performance and is recommended where possible. 2D calibration involves one level rotation about the Z axis and is designed for vehicles that cannot easily or safely be turned upside down, such as boats.



Please note that if Subsonus Tag is going to be used in a vehicle or vessel, the calibration should be performed while the Tag is mounted in and fixed to that vehicle. This means that the whole vehicle must be moved to perform the calibration. The calibration needs to be performed in an area as far away as practical away from sources of magnetic interference. For example, if Subsonus Tag is installed on an ROV, the calibration should not be done on a steel deck or over reinforced concrete etc. If Subsonus Tag is being calibrated to operate standalone, the calibration should not be done on a desk with a steel frame.



*Illustration 44: Magnetic Calibration Page*

### **11.13.1 Begin New 3D Magnetic Calibration**

Perform a 3D calibration by following the steps in the Tag Manager application. Rotation about 3 axes will be required, so ensure the object or Tag is free to move.

The Calibration procedure will display how the Tag is to be rotated for each step before starting, as shown in illustrations 45, 47, and 49. On these pages, press “Start” to begin.

A progress bar is displayed for each step, as shown in illustrations 46, 48, and 50. Continue to rotate until the calibration step completes, then press “Continue”.

When the final step is completed, press “Continue” to apply the calibration. The screen in



Illustration 58 will be displayed.

If an error occurs, as in Illustration 57, then the step can be re-run until successful. Each step may be retried as often as necessary, and no changes will be made until the final step is completed successfully.

The new calibration values written to the Subsonus Tag may be viewed on the “View / Edit Calibration Values” page (section 11.13.4 ). Example values from a 3D calibration can be seen in Illustration 53. This is an example only and values will vary according to installation conditions.

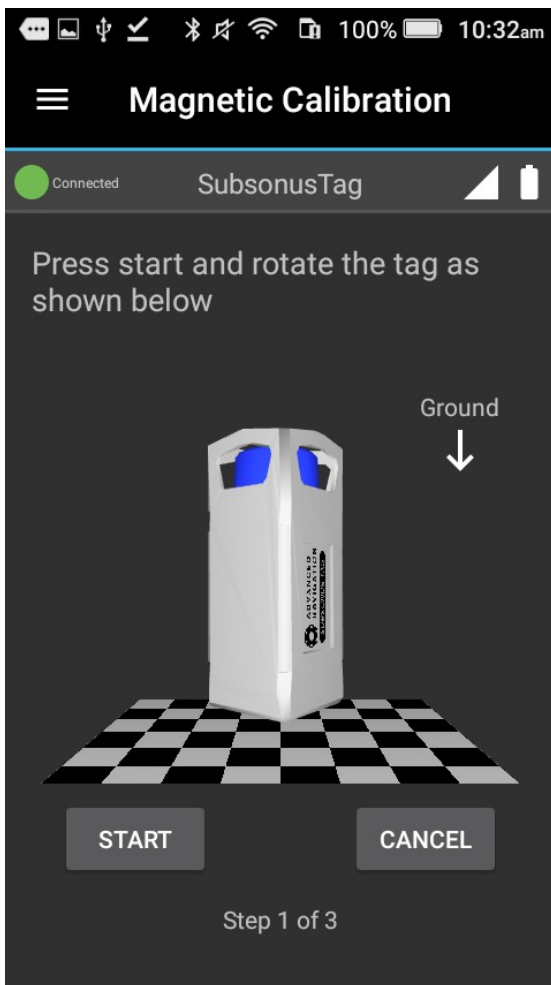


Illustration 45: 3D magnetic calibration Z-axis start

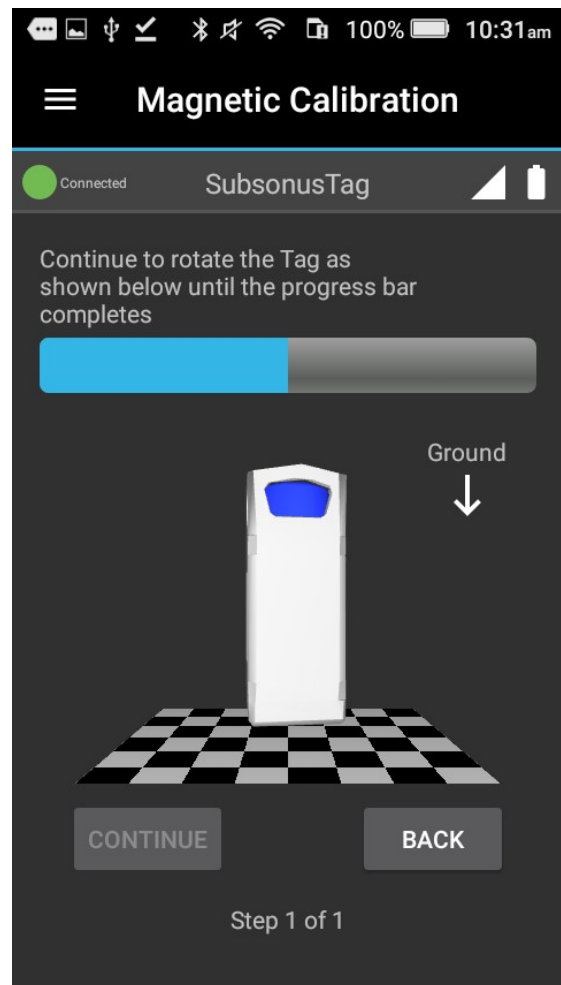


Illustration 46: 3D magnetic calibration Z-axis progress

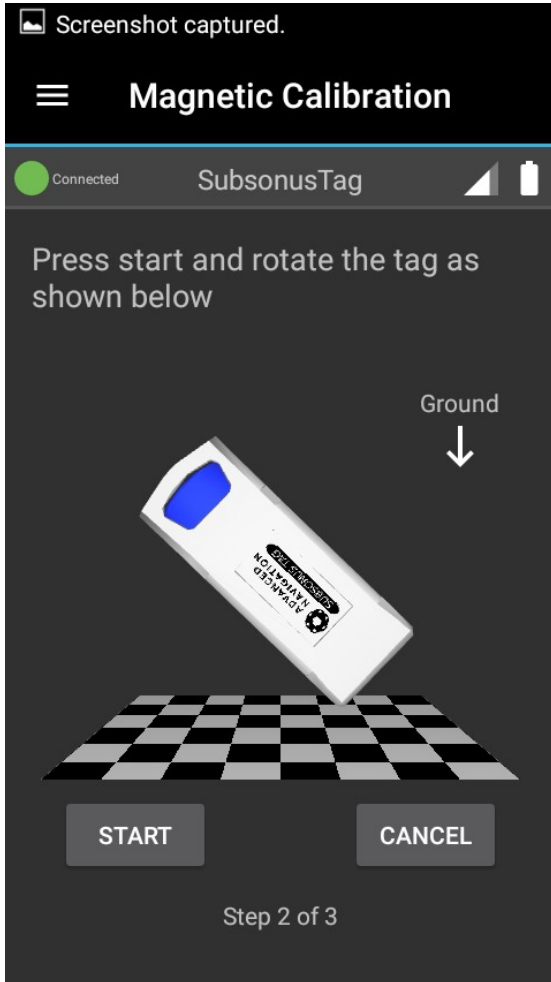


Illustration 47: 3D magnetic calibration X-axis start

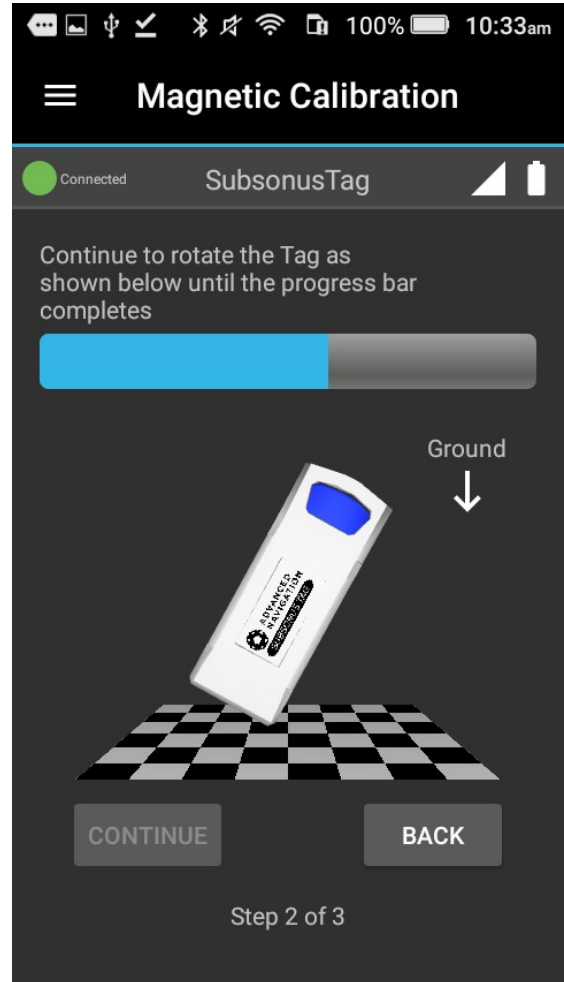


Illustration 48: 3D magnetic calibration X-axis progress



Illustration 49: 3D magnetic calibration Y-axis start



Illustration 50: 3D magnetic calibration Y-axis progress





Illustration 51: 3D magnetic calibration error

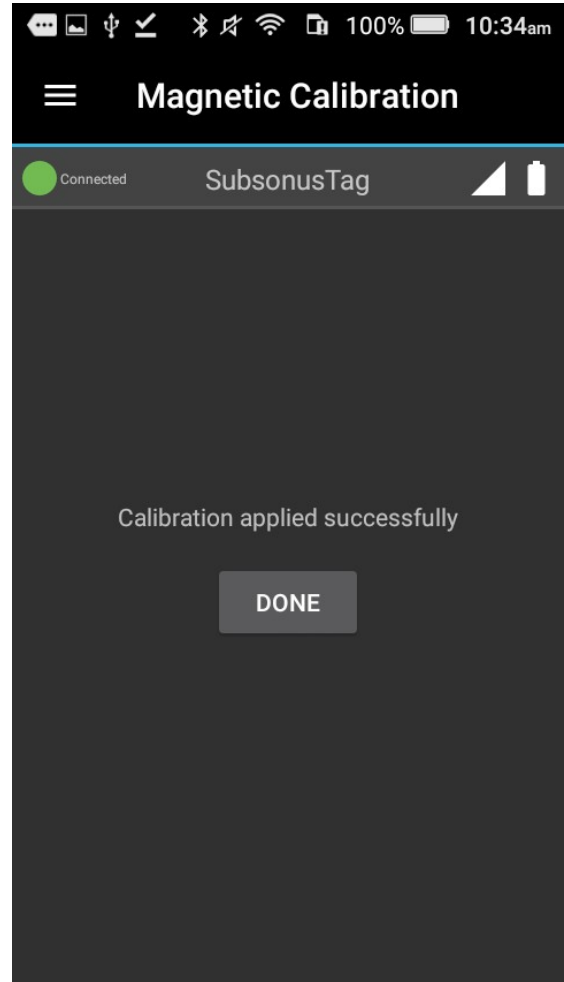
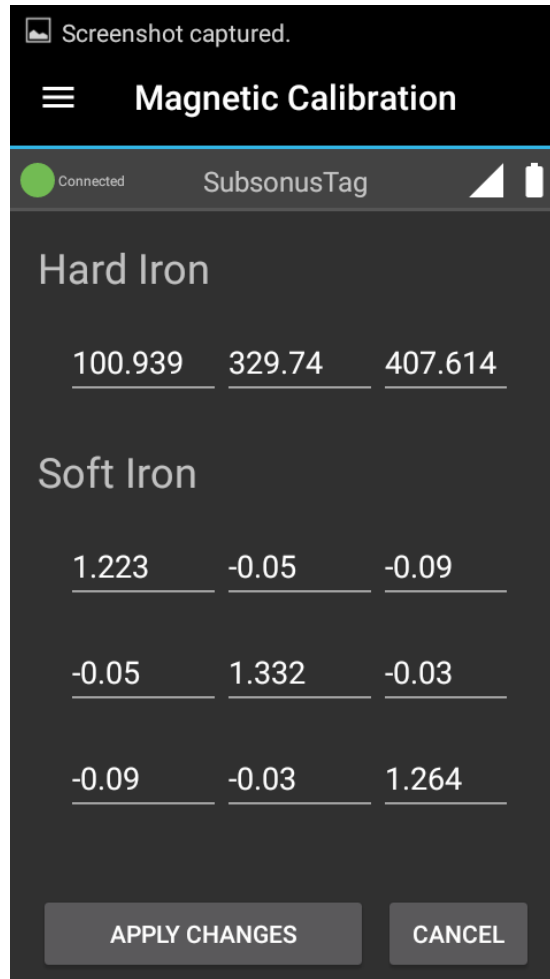


Illustration 52: 3D magnetic calibration applied



*Illustration 53: 3D magnetic calibration example values*

### 11.13.2 Begin New 2D Magnetic Calibration

If Subsonus Tag is attached to a vehicle that cannot be rotated about all three axes, then a 2D calibration, rotating about only one axis, is supported.

The Calibration procedure will display how the Tag is to be rotated (Illustration 54). Press “Start” to begin.

A progress bar will be displayed (Illustration 55). Continue to rotate until the calibration step completes (Illustration 56). Press “Continue” to apply the calibration, the screen in Illustration 58 will be displayed.

If an error occurs, as in Illustration 45, then the step can be-run until successful. Each step may be retried as often as necessary, and no changes will be made until the final step is completed successfully.

The new calibration values written to the Subsonus Tag may be viewed on the “View / Edit Calibration Values” page (section 11.13.4 ). Example values from a 2D calibration can be seen in Illustration 59. This is an example only and values will vary according to installation conditions. All 2D calibrations will have the same 0s and 1s in the last row/column.



Illustration 54: 2D magnetic calibration start

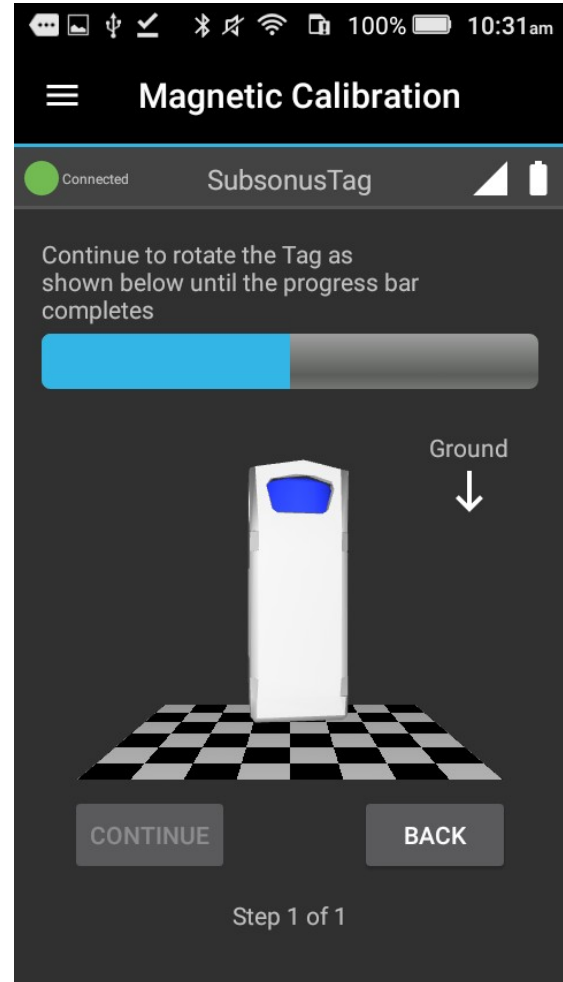
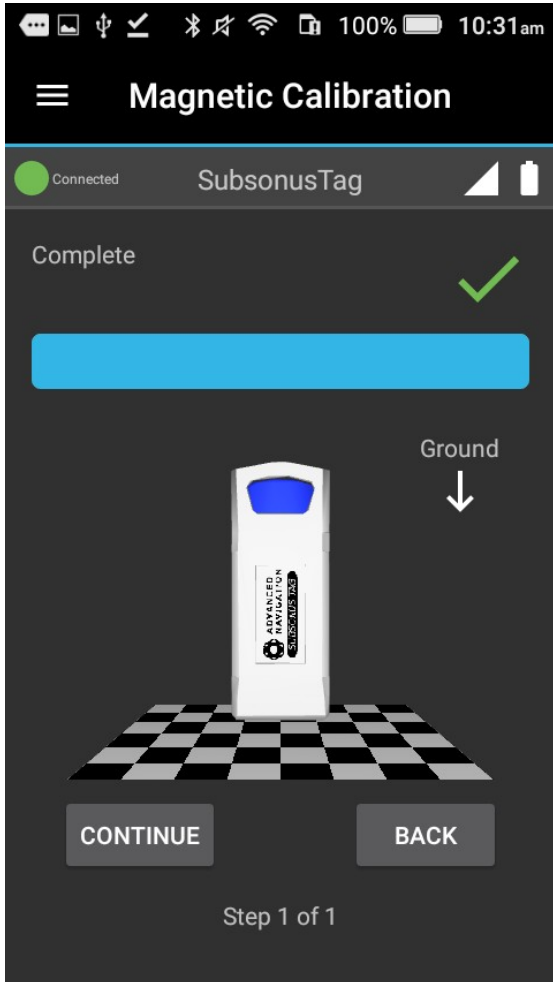
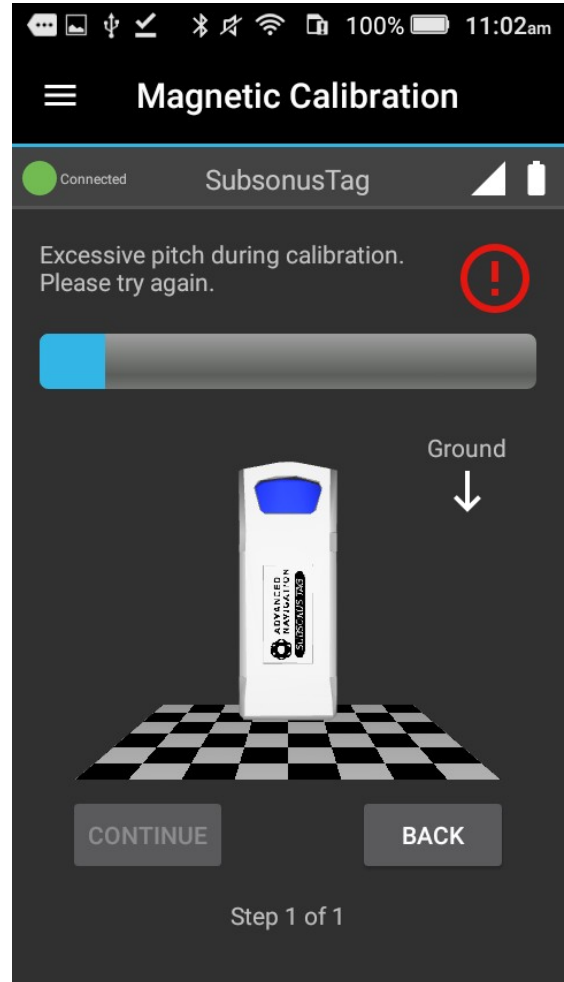


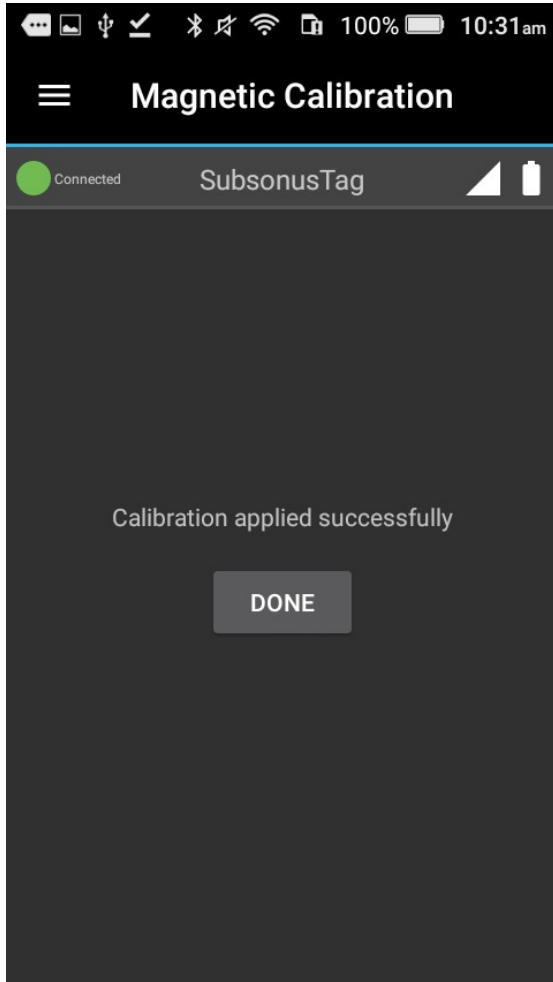
Illustration 55: 2D magnetic calibration ongoing



*Illustration 56: 2D magnetic calibration finished*



*Illustration 57: 2D magnetic calibration error*



*Illustration 58: 2D magnetic calibration applied*

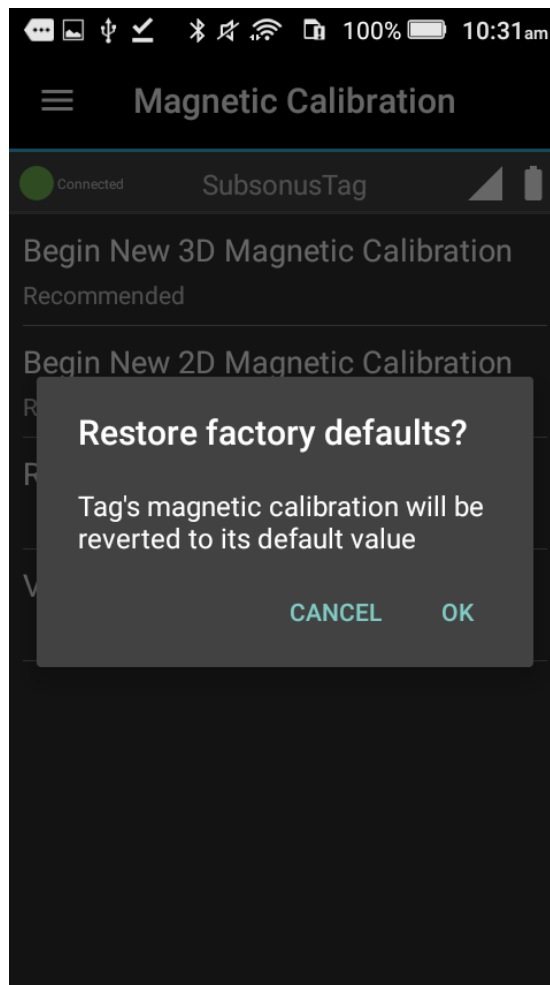


*Illustration 59: 2D magnetic calibration example values*



### 11.13.3 Restore Factory Defaults

Permanently revert the unit's current magnetic calibration values to their factory configuration. A pop-up will be displayed for confirmation, see Illustration 60.



*Illustration 60: Restore magnetic calibration factory defaults*

### 11.13.4 View / Edit Calibration Values

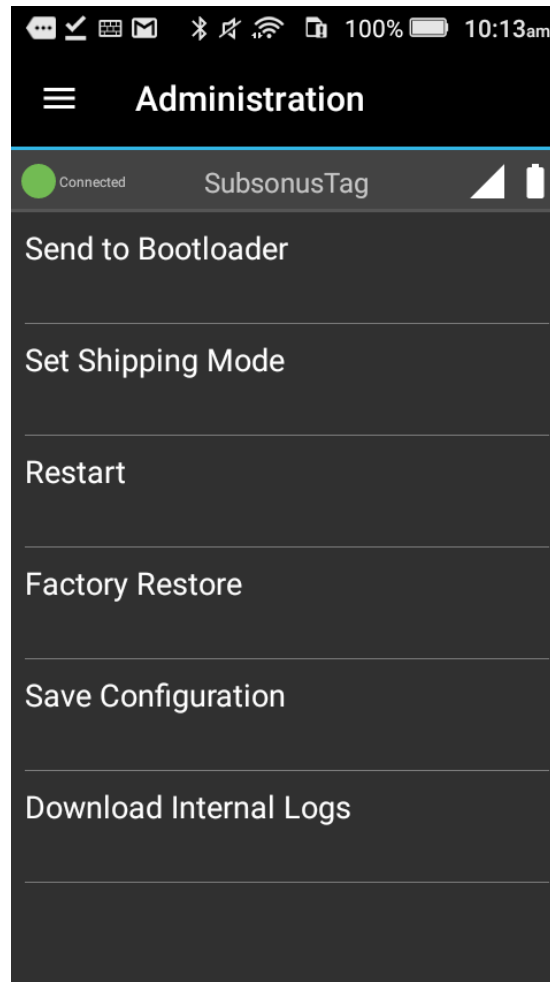
The current magnetic calibration values for the Subsonus Tag can be viewed to ensure that calibrations have been applied successfully. Modifying these values manually is not advised. This page can be seen in Illustration 61.



*Illustration 61: View / Edit magnetic calibration values*

## 11.14 Administration

The administration page provides the ability to Restart, Factory Restore, or put a Tag into Shipping Mode. See Illustration 62.



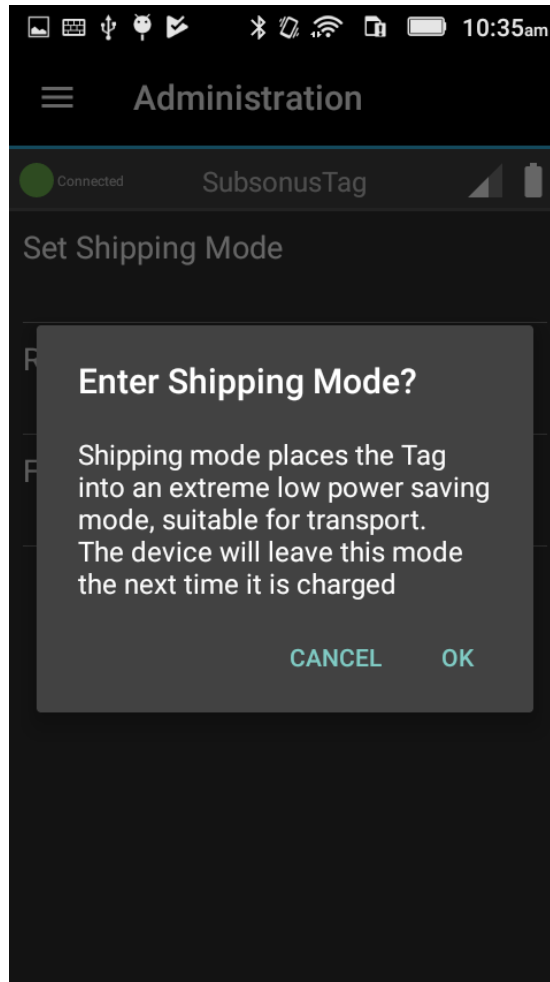
*Illustration 62: Administration Page*

### **11.14.1 Set Shipping Mode**

When setting Shipping mode a pop-up will be displayed asking for confirmation – see Illustration 63. Note that entering shipping mode will turn off the Tag and disconnect it from the Tag Manager application. The only way to exit shipping mode is to place the Tag on a charger.

Subsonus Tag should be placed in shipping mode for transport or storage.





*Illustration 63: Shipping Mode confirmation*

#### **11.14.2 Factory Restore**

Pressing “Factory Restore” will reset all settings on the Tag to defaults. Subsonus Tag will be set to Performance Mode on Factory Restore

#### **11.14.3 Save Configuration**

The Save Configuration button will save a file, containing the Subsonus Tag configuration, to the handset file-system.

This configuration file includes all settings that can be viewed and configured from the Subsonus Tag Manager application.

#### **11.14.4 Download Internal Logs**

This is a tool to download logs that Advanced Navigation engineers can use to diagnose issues with instrument performance. Customer Support may request these logs.

### **11.15 Troubleshooting**

Please contact [support@advancednavigation.com.au](mailto:support@advancednavigation.com.au) if you are having issues.



### **11.15.1 Bluetooth Permissions**

Bluetooth discovery requires location permissions to run on android, please ensure that the Tag Manager application has appropriate permissions.

### **11.15.2 Discovery not working**

In the event that the Subsonus Tag Manager application cannot discover a Subsonus Tag, the handset Bluetooth could need to be restarted.



## **12 Configuration**

### **12.1 Device Configuration**

#### **12.1.1 Display Name**

Display name is a user settable name for the Subsonus Tag, this name is visible on the Tag's screen and can be used to easily identify tags. This name will be automatically detected and displayed when the Tag is tracked by a Subsonus. The name can be configured via Bluetooth.

#### **12.1.2 Operation Mode**

Subsonus Tag can be configured to act in Performance Mode or in Endurance Mode. Performance mode should be used for short term deployments where the tag is expected to be interrogated more than once every hour. See section 10.8

#### **12.1.3 Device Address**

Subsonus Tag should be configured with a device address for unique identification by a Subsonus. For more information see section 9.3

#### **12.1.4 Range**

Subsonus Tag can be configured with a maximum expected operating range, this setting allows the transmit power to be limited in short range applications preserving battery life.

In high noise environments the range can be set higher than the actual expected operating range, in order to compensate for worse signal to noise ratios.

By default range is set to maximum, it should only be reduced if extended operating duration is required.

### **12.2 Alignment Configuration**

Subsonus Tag should have orientation offsets applied if the Tag is not mounted in the recommended orientation relative to the tracked device.

#### **12.2.1 Alignment Offset**

If Subsonus Tag is not mounted in a standard orientation an Alignment Offset will need to be configured, in order to have the Tag's orientation output represent the attached devices orientation.

See section 5.3 for the alignment directions.

### **12.3 Acoustic Data Priority**

Subsonus Tag's data can be read acoustically by a Subsonus, this data needs to be transported on the acoustic communication channel, this channel is bandwidth limited so data required for the application should be given the highest priority.

### **12.4 Shipping Mode**

Subsonus Tag can be placed in "Shipping Mode" from its Bluetooth interface, in this mode the tag is off and will not communicate via Bluetooth or acoustically. The screen will display "Shipping mode" when in this state. To leave shipping mode the tag must be placed on a Qi charger. When



transporting or storing the Tag it should be placed in shipping mode.



## **13 Maintenance**

### **13.1 Inspections**

The following inspections should be performed prior to deployment and after retrieval.

#### **13.1.1 Damage**

Inspect the protective shell for deep scratches and cracks. Inspect the blue transducer array for any cuts, gouges or damage. In the event of any damage please email a photo to [support@advancednavigation.com.au](mailto:support@advancednavigation.com.au) for advice before deployment.

#### **13.1.2 Biofouling**

Inspect for biofouling such as barnacles and other marine growth. Follow the service procedures in section 13.2 for removal of biofouling.

Biocides must be compatible with ASA plastics and polyurethanes.

### **13.2 Cleaning**

Soft marine growth should be gently removed using a soft bristled brush and soapy water. If hard marine growth such as barnacles have attached to the transducer they should not be pulled off with force as this may permanently damage the moulded surface.

The recommended way to remove hard marine growth it is to soak the unit in a weak solution (8-10%) of Sulphamic acid. An example product containing Sulphamic acid is Lime-A-Way thick gel. Once the acid has softened the growth it should fall away when brushed down. Strong acids should not be used to remove biofouling on Subsonus Tag as this can cause surface damage to the plastics.



## **14 Device Address**

A “Device Address” is a number used by Subsonus to control tracking behaviour as well as associate data streams with devices and to identify devices for configuration using ANPP. Each device needs to be assigned a unique Device Address to function properly.

Device Addresses are usually assigned sequentially. If two devices are assigned the same address a “conflict” occurs and the Subsonus web interface will display an alert. The conflict can be resolved by changing one of the devices to a different address. Subsonus cannot track two devices with the same address simultaneously.

### **14.1 Device Address Tracking Behaviour**

#### **14.1.1 Subsonus Tag**

A Subsonus Tag can be tracked by a Subsonus Master and will respond to a master on any Device Address.

##### **14.1.1.1 Automatic Device Address**

A Tag set to device Address Zero will be automatically assigned a device address by the first master that acoustically discovered it. Once this address is set, it is permanent and any address conflicts must be resolved by the user.

### **14.2 Hot Swap**

Subsonus Tag can be swapped out for another device with the same device address, for example a change to a fully charged battery. The tracking history and tracking configuration in the Subsonus will persist to the new Tag.

### **14.3 Device Address Conflict**

Subsonus Tag needs to have a unique Device Address to communicate. If multiple devices have the same Device Address a conflict will occur. Conflicts can only be resolved by changing the Device Address of one of the devices or by removing a device from the conversation. A Subsonus Device Address can be changed locally on the Subsonus Tag using Bluetooth or remotely via acoustics from the Master Subsonus.

#### **14.3.1 Device Address Conflict Display in Subsonus**

Devices with Address conflicts will be displayed on the “Configuration” → “Devices” page. Devices with conflicting addresses will be indicated by a red “alert” icon alongside the entry in the device list. Subsonus cannot track multiple devices on the same Device Address, if two or more tracked targets share a Device Address, the conflict must be resolved before tracking can continue. To resolve a conflict the Device Address of all the devices must be made unique.



## **15 Compliance**

### **15.1 FCC**

This equipment has been tested and found to comply with the limits for a Class B digital device, pursuant to part 15 of the FCC Rules. These limits are designed to provide reasonable protection against harmful interference in a residential installation. This equipment generates, uses and can radiate radio frequency energy and, if not installed and used in accordance with the instructions, may cause harmful interference to radio communications. However, there is no guarantee that interference will not occur in a particular installation. If this equipment does cause harmful interference to radio or television reception, which can be determined by turning the equipment off and on, the user is encouraged to try to correct the interference by one or more of the following measures:

Reorient or relocate the receiving antenna.

Increase the separation between the equipment and receiver.

Connect the equipment into an outlet on a circuit different from that to which the receiver is connected.

Consult the dealer or an experienced radio/TV technician for help

### **15.2 IC (Canada)**

This equipment has been tested and found to comply with the limits for a Class B digital device, pursuant to RSS-210 of the IC Rules. These limits are designed to provide reasonable protection against harmful interference in a residential installation. This equipment generates, uses and can radiate radio frequency energy and, if not installed and used in accordance with the instructions, may cause harmful interference to radio communications. However, there is no guarantee that interference will not occur in a particular installation. If this equipment does cause harmful interference to radio or television reception, which can be determined by turning the equipment off and on, the user is encouraged to try to correct the interference by one or more of the following measures:

Reorient or relocate the receiving antenna.

Increase the separation between the equipment and receiver.

Connect the equipment into an outlet on a circuit different from that to which the receiver is connected.

Consult the dealer or an experienced radio/TV technician for help.



Information in this document is provided solely in connection with Advanced Navigation products. Advanced Navigation reserves the right to make changes, corrections, modifications or improvements, to this document, and the products and services described herein at any time, without notice.

All Advanced Navigation products are sold pursuant to Advanced Navigation's terms and conditions of sale. Purchasers are solely responsible for the choice, selection and use of the Advanced Navigation products and services described herein, and Advanced Navigation assumes no liability whatsoever relating to the choice, selection or use of the Advanced Navigation products and services described herein.

No license, express or implied, by estoppel or otherwise, to any intellectual property rights is granted under this document. If any part of this document refers to any third party products or services it shall not be deemed a license grant by Advanced Navigation for the use of such third party products or services, or any intellectual property contained therein or considered as a warranty covering the use in any manner whatsoever of such third party products or services or any intellectual property contained therein.

UNLESS OTHERWISE SET FORTH IN ADVANCED NAVIGATION'S TERMS AND CONDITIONS OF SALE ADVANCED NAVIGATION DISCLAIMS ANY EXPRESS OR IMPLIED WARRANTY WITH RESPECT TO THE USE AND/OR SALE OF ADVANCED NAVIGATION PRODUCTS INCLUDING WITHOUT LIMITATION IMPLIED WARRANTIES OF MERCHANTABILITY, FITNESS FOR A PARTICULAR PURPOSE (AND THEIR EQUIVALENTS UNDER THE LAWS OF ANY JURISDICTION), OR INFRINGEMENT OF ANY PATENT, COPYRIGHT OR OTHER INTELLECTUAL PROPERTY RIGHT.

UNLESS EXPRESSLY APPROVED IN WRITING BY TWO AUTHORISED ADVANCED NAVIGATION REPRESENTATIVES, ADVANCED NAVIGATION PRODUCTS ARE NOT RECOMMENDED, AUTHORISED OR WARRANTED FOR USE IN MILITARY, AIR CRAFT, SPACE, LIFE SAVING, OR LIFE SUSTAINING APPLICATIONS, NOR IN PRODUCTS OR SYSTEMS WHERE FAILURE OR MALFUNCTION MAY RESULT IN PERSONAL INJURY, DEATH, OR SEVERE PROPERTY OR ENVIRONMENTAL DAMAGE.

ADVANCED NAVIGATION PRODUCTS WHICH ARE NOT SPECIFIED AS "AUTOMOTIVE GRADE" MAY ONLY BE USED IN AUTOMOTIVE APPLICATIONS AT USER'S OWN RISK.

Resale of Advanced Navigation products with provisions different from the statements and/or technical features set forth in this document shall immediately void any warranty granted by Advanced Navigation for the Advanced Navigation product or service described herein and shall not create or extend in any manner whatsoever, any liability of Advanced Navigation.

Information in this document supersedes and replaces all information previously supplied.

© 2024 Advanced Navigation - All rights reserved