

**ADVANCED
NAVIGATION**



**Certus Rugged
Certus Evo Rugged**

Reference Manual

Contents

1 Revision History	1
2 Introduction	3
2.1 Firmware Changelog	4
2.2 Hardware Changelog	8
3 Rugged Evaluation Kit	9
3.1 Rugged Evaluation Kit Contents	10
4 Getting Started	12
5 Part Numbers and Ordering Options	13
5.1 Evaluation Kits	13
5.2 Standalone Units	14
5.3 Antennas	15
5.4 GNSS Receiver License Upgrades	15
5.5 Accessories	15
6 Specifications	17
6.1 Navigation Specifications	17
6.1.1 Certus Specifications	17
6.1.2 Certus Evo Specifications	18
6.1.3 Heading Accuracy	18
6.2 Sensor Specifications	19
6.2.1 Certus Specifications	19
6.2.2 Certus Evo Specifications	19
6.2.3 GNSS Specifications	20
6.3 Hardware Specifications	21
6.3.1 Certus Hardware Specifications	21
6.3.2 Certus Evo Hardware Specifications	21
6.3.3 Certus and Certus Evo Environmental Specifications	22
6.3.4 Rugged Mechanical Drawings	23
6.3.4.1 Certus Rugged Mechanical Drawings	23
6.3.4.2 Certus Evo Rugged Mechanical Drawings	24
6.3.4.3 Centre of Gravity Location of Certus	25
6.3.4.4 Centre of Gravity Location of Certus Evo	25
6.3.5 Serial Number	26
6.4 Communication Specifications	26
6.5 Electrical Specifications	27
6.6 Connector Pin-out	29

6.6.1 8 Pin Connector	29
6.6.2 16 Pin Connector	30
6.7 IO Connection	32
6.7.1 8 Pin IO Breakout Cable	32
6.7.2 16 Pin IO Breakout Cable	33
7 Installing Certus	35
7.1 Installation Checklist	35
7.2 Mounting Certus	36
7.2.1 Mounting Plate Layout	37
7.3 Power Supply	37
7.4 Electrical Domains	38
7.5 GNSS Antennas	38
7.5.1 Antenna Cables	42
7.5.2 Antenna Suction Cup Mount	42
7.5.3 Antcom Antenna Survey Mount Assembly	43
7.6 Networking	43
7.7 Odometer	43
7.7.1 Factory VSS Signal	43
7.7.2 OBDII Odometer Interface	44
7.7.3 Aftermarket Wheel Speed Sensor	45
7.7.4 Radar Speed Sensor	46
7.8 Magnetics	46
7.9 Vibration	47
8 Using Certus	48
8.1 Filter Initialisation	49
8.1.1 Orientation Initialisation	49
8.1.2 Navigation Initialisation	49
8.1.3 Heading Initialisation	49
8.1.4 Time Initialisation	50
8.2 Hot Start	50
8.3 Time	50
8.4 Heading Sources	51
8.4.1 Dual Antenna Heading	51
8.4.2 Velocity Heading	51
8.4.3 Magnetic Heading	51
8.4.4 External Heading	51
8.4.5 External Magnetometers Packet	51
8.5 Magnetic Calibration	52
8.5.1 2D Magnetic Calibration	52
8.5.1.1 2D Magnetic Calibration Using the Web UI or Certus Manager Software	52
8.5.1.2 2D Magnetic Calibration Using the Packet Protocol	53
8.5.2 3D Magnetic Calibration	53

8.5.2.1 3D Magnetic Calibration Using the Web UI or Certus Manager Software	53
8.5.2.2 3D Magnetic Calibration Using the Packet Protocol	54
8.5.3 Automatic Magnetic Calibration	54
8.5.3.1 2D Vehicle Profiles	54
8.5.3.2 3D Vehicle Profiles	54
8.5.4 Disabling Magnetometers	55
8.6 Sensor Ranges	55
8.7 Data Anti-aliasing	55
8.8 Vehicle Profiles	55
8.9 Atmospheric Altitude	56
8.10 Odometer Pulse Length	56
8.10.1 Calibrating Odometer Automatic Pulse Length	56
8.11 Reversing Detection	56
8.12 Motion Analysis	56
8.13 RTK	57
8.13.1 Network RTK Corrections (NTRIP)	57
8.13.2 Radio Modem RTK Corrections	58
8.13.3 Supported RTCM Messages	58
8.14 Raw Satellite Data	58
8.15 Kinematica Post Processing	59
8.16 Vents	59
8.17 RAIM	59
8.18 Heave	60
8.19 Environmental Exposure	60
8.19.1 Temperature	60
8.19.2 Water	60
8.19.3 Salt	61
8.19.4 Dirt and Dust	61
8.19.5 pH Level	61
8.19.6 Shocks	61
8.19.7 Atmospheres	61
8.20 Upgrading the Certus Firmware	61
9 Configuring and Monitoring Certus	62
9.1 Using the Web User Interface	62
9.1.1 Main View	63
9.1.1.1 Status Indicator	63
9.1.1.2 Current Time, Position and Heading	64
9.1.1.3 Altitude Indicator	64
9.1.1.4 Satellites Table	64
9.1.1.5 Map	64
9.1.1.6 Map Controls	64
9.1.2 View Menu	64
9.1.2.1 Map	64

9.1.2.2 Device Information	65
9.1.2.3 Subcomponent Information	65
9.1.2.4 Status	66
9.1.2.5 Satellites	67
9.1.2.6 Raw Sensors	68
9.1.2.7 Orientation	69
9.1.2.8 Position	70
9.1.2.9 Velocity and Acceleration	71
9.1.2.10 GNSS Receiver Information	71
9.1.2.11 Heave	72
9.1.3 Configuration Menu	72
9.1.3.1 Sensor Ranges	72
9.1.3.2 Filter Options	73
9.1.3.3 Data Ports	73
9.1.3.4 Alignment	75
9.1.3.5 Baud Rates	76
9.1.3.6 GPIO	76
9.1.3.7 Odometer	76
9.1.3.8 Reset	77
9.1.3.9 Reference Point Offsets	77
9.1.3.10 Manual Initialisation	78
9.1.3.11 Dual Antenna	78
9.1.3.12 Ethernet Settings	79
9.1.3.13 NTRIP Client	79
9.1.3.14 CAN Settings	81
9.1.3.15 Advanced	82
9.1.3.16 GNSS Configuration	82
9.1.4 Tools Menu	84
9.1.4.1 Firmware Update	85
9.1.4.2 Logs	86
9.1.4.3 Viewing Logged Data	87
9.2 Using Certus Manager	88
9.2.1 Certus Manager Software Changelog	89
9.2.2 System Requirements	91
9.2.3 Installation and Starting	91
9.2.4 Troubleshooting	91
9.2.4.1 Windows	91
9.2.4.2 Linux	93
9.2.5 Main View	94
9.2.5.1 Serial Port	94
9.2.5.2 Attitude Indicator	95
9.2.5.3 Satellites Table	95
9.2.5.4 Status Indicator	95

9.2.5.5 3D Map	95
9.2.5.6 3D Map Controls	95
9.2.5.7 Baud Rate	95
9.2.5.8 Connect / Disconnect	95
9.2.6 View Menu	96
9.2.6.1 View	96
9.2.6.2 Device Information	96
9.2.6.3 Status	97
9.2.6.4 Satellites	98
9.2.6.5 Raw Sensors	99
9.2.6.6 Orientation	100
9.2.6.7 Position	101
9.2.6.8 Velocity and Acceleration	102
9.2.6.9 Time	102
9.2.6.10 Communications	103
9.2.6.11 GNSS Receiver Information	103
9.2.6.12 Heave	104
9.2.7 Configuration Menu	104
9.2.7.1 Configuration Export	105
9.2.7.2 Sensor Ranges	105
9.2.7.3 Filter Options	106
9.2.7.4 Packet Rates	107
9.2.7.5 Alignment	108
9.2.7.6 Port Mode and Baud Rates	109
9.2.7.7 GPIO	110
9.2.7.8 Odometer	110
9.2.7.9 Reset	111
9.2.7.10 Reference Position Offsets	112
9.2.7.11 GPIO Output	113
9.2.7.12 Manual Initialisation	114
9.2.7.13 Dual Antenna	115
9.2.7.14 Gimbal	116
9.2.7.15 Ethernet Settings	116
9.2.7.16 GNSS Configuration	117
9.2.7.17 CAN Settings	118
9.2.8 Tools Menu	119
9.2.8.1 Device Discovery	119
9.2.8.2 Magnetic Calibration	120
9.2.8.3 Firmware Update	120
9.2.8.4 GNSS Firmware Update	123
9.2.8.5 Log Converter	124
9.2.8.6 NTRIP Client	125
9.2.8.7 Network Connect	125

9.2.8.8 Serial Passthrough	126
9.2.9 Logging	126
9.3 Using the Android App	126
9.4 Using ANPP	127
10 Interfacing	128
10.1 Ethernet	128
10.1.1 Ethernet Modes	128
10.1.2 Ethernet Functions	129
10.1.2.1 NMEA Input	130
10.1.2.2 Novatel GNSS Input	130
10.1.2.3 Topcon GNSS Input	130
10.1.2.4 ANPP Input	131
10.1.2.5 RTCM Differential GNSS Corrections Input	131
10.1.2.6 Trimble GNSS Input	131
10.1.2.7 u-blox GNSS Input	131
10.1.2.8 Hemisphere GNSS Input	131
10.1.2.9 Teledyne DVL Input	131
10.1.2.10 Trittech USBL Input	131
10.1.2.11 Linkquest DVL Input	131
10.1.2.12 Nortek DVL Input	131
10.1.2.13 NMEA Output	132
10.1.2.14 ANPP Output	132
10.1.2.15 TSS1 Output	132
10.1.2.16 Simrad 1000 Output	132
10.1.2.17 Simrad 3000 Output	132
10.1.2.18 Serial Port Passthrough	132
10.1.2.19 GNSS Receiver Passthrough	133
10.2 Serial Interface	133
10.2.1 Baud Rate	133
10.2.2 Format	133
10.3 1PPS Signal	133
10.4 CAN Interface	134
10.5 External Data	134
10.6 GPIO Pins and the Auxiliary Port	134
10.6.1 Dynamic Pin Functions	135
10.6.1.1 Inactive	136
10.6.1.2 1PPS Output	136
10.6.1.3 GNSS Fix Output	137
10.6.1.4 Zero Velocity Input	137
10.6.1.5 Disable Magnetometers	137
10.6.1.6 Disable GNSS	137
10.6.1.7 Disable Pressure	138
10.6.1.8 Set Zero Orientation Alignment	138

10.6.1.9 System State Packet Trigger	138
10.6.1.10 Raw Sensors Packet Trigger	138
10.6.1.11 1PPS Input	139
10.6.1.12 Event 1 Input	139
10.6.1.13 Event 2 Input	139
10.6.1.14 Odometer Direction, Forward Low	139
10.6.1.15 Odometer Direction, Forward High	139
10.6.1.16 Reverse Alignment, Forward Low	140
10.6.1.17 Reverse Alignment, Forward High	140
10.6.1.18 Zero Angular Velocity Input	140
10.6.1.19 Odometer Input	140
10.6.1.20 Pitot Tube Input	141
10.6.1.21 Pressure Depth Transducer (deprecated)	141
10.6.1.22 Left Wheel Speed Sensor	141
10.6.1.23 Right Wheel Speed Sensor	141
10.6.1.24 Wheel Speed Sensor	141
10.6.1.25 Wheel Encoder Phase A	142
10.6.1.26 Wheel Encoder Phase B	142
10.6.1.27 Gimbal Encoder Phase A	142
10.6.1.28 Gimbal Encoder Phase B	142
10.6.1.29 NMEA Input	143
10.6.1.30 Novatel GNSS Input	143
10.6.1.31 Topcon GNSS Input	144
10.6.1.32 ANPP Input	144
10.6.1.33 RTCM Differential GNSS Corrections Input	144
10.6.1.34 Trimble GNSS Input	144
10.6.1.35 u-blox GNSS Input	144
10.6.1.36 Hemisphere GNSS Input	145
10.6.1.37 Teledyne DVL Input	145
10.6.1.38 Trittech USBL Input	145
10.6.1.39 Linkquest DVL Input	145
10.6.1.40 Linkquest USBL Input	145
10.6.1.41 Nortek DVL Input	146
10.6.1.42 NMEA Output	146
10.6.1.43 ANPP Output	146
10.6.1.44 TSS1 Output	147
10.6.1.45 Simrad 1000 Output	147
10.6.1.46 Simrad 3000 Output	147
10.6.1.47 Serial Port Passthrough	147
10.6.1.48 GNSS Receiver Passthrough	147
11 Advanced Navigation Packet Protocol	149
11.1 About Packets	151
11.1.1 Packet Structure	151

11.1.1.1 Header LRC	152
11.1.1.2 Packet ID	152
11.1.1.3 Packet Length	152
11.1.1.4 CRC	152
11.1.2 Packet Requests	152
11.1.3 Packet Acknowledgement	152
11.1.4 Packet Rates	153
11.1.5 Packet Timing	153
11.2 Data Types	153
11.3 System Packets	154
11.3.1 Acknowledge Packet	154
11.3.1.1 Acknowledge Result	154
11.3.2 Request Packet	154
11.3.3 Boot Mode Packet	155
11.3.3.1 Boot Mode Types	155
11.3.4 Device Information Packet	155
11.3.4.1 Device ID	156
11.3.5 Restore Factory Settings Packet	156
11.3.6 Reset Packet	157
11.3.6.1 Verification Sequence Values	157
11.3.7 Serial Port Passthrough Packet	157
11.3.7.1 Passthrough Route	157
11.3.8 IP Configuration Packet	158
11.3.8.1 DHCP Mode	158
11.3.8.2 Link Mode Index	158
11.3.8.3 Discovery Network Setting Overwrite	158
11.3.9 Extended Device Information Packet	159
11.3.9.1 Device Sub-type	159
11.3.10 Subcomponent Information Packet	159
11.3.10.1 Subcomponent Device ID	160
11.4 State Packets	161
11.4.1 System State Packet	163
11.4.1.1 System Status	164
11.4.1.2 Filter Status	165
11.4.1.3 GNSS Fix Status	165
11.4.1.4 Unix Time Seconds	165
11.4.1.5 Microseconds	166
11.4.2 Unix Time Packet	166
11.4.3 Formatted Time Packet	166
11.4.4 Status Packet	167
11.4.5 Position Standard Deviation Packet	167
11.4.6 Velocity Standard Deviation Packet	167
11.4.7 Euler Orientation Standard Deviation Packet	168

11.4.8 Quaternion Orientation Standard Deviation Packet	168
11.4.9 Raw Sensors Packet	169
11.4.10 Raw GNSS Packet	170
11.4.10.1 Raw GNSS Status	170
11.4.11 Satellites Packet	171
11.4.12 Geodetic Position Packet	172
11.4.13 ECEF Position Packet	172
11.4.14 UTM Position Packet	172
11.4.15 NED Velocity Packet	173
11.4.16 Body Velocity Packet	173
11.4.17 Acceleration Packet	173
11.4.18 Body Acceleration Packet	174
11.4.19 Euler Orientation Packet	174
11.4.20 Quaternion Orientation Packet	174
11.4.21 DCM Orientation Packet	175
11.4.22 Angular Velocity Packet	175
11.4.23 Angular Acceleration Packet	176
11.4.24 External Position and Velocity Packet	176
11.4.25 External Position Packet	177
11.4.26 External Velocity Packet	177
11.4.27 External Body Velocity Packet	178
11.4.28 External Heading Packet	178
11.4.29 Running Time Packet	178
11.4.30 Local Magnetic Field Packet	179
11.4.31 Odometer State Packet	179
11.4.32 External Time Packet	179
11.4.33 External Depth Packet	180
11.4.34 Geoid Height Packet	180
11.4.35 RTCM Corrections Packet	180
11.4.36 Wind Packet	181
11.4.37 Heave Packet	181
11.4.38 Raw Satellite Data Packet	181
11.4.38.1 Satellite Systems	182
11.4.38.2 Satellite Frequencies	183
11.4.38.3 Tracking Status	183
11.4.39 Raw Satellite Ephemeris Packet	183
11.4.39.1 GPS Flags	185
11.4.40 External Odometer Packet	185
11.4.40.1 Odometer Flags	186
11.4.41 External Air Data Packet	187
11.4.41.1 External Air Data Flags	187
11.4.42 GNSS Receiver Information Packet	188
11.4.42.1 Aries GNSS Receiver	188

11.4.42.2 Trimble BD992 GNSS Receiver	188
11.4.42.3 GNSS Manufacturer IDs and Receiver Models	189
11.4.42.4 Omnistar Engine Modes	189
11.4.42.5 RTK Software License Accuracy	189
11.4.43 Raw DVL Data Packet	190
11.4.43.1 Raw DVL Data Flags	190
11.4.44 Gimbal State Packet	191
11.4.45 Automotive Packet	191
11.4.46 External Magnetometers Packet	191
11.4.46.1 External Magnetometers Flags	192
11.4.47 Basestation Packet	192
11.4.47.1 GNSS Fix Status	193
11.4.48 Zero Angular Velocity Packet	193
11.4.48.1 Zero Angular Velocity Duration	193
11.4.49 Extended Satellites Packet	193
11.4.49.1 Satellite Systems	194
11.4.49.2 Satellite Frequencies	194
11.4.49.3 Extended Satellites Flags	195
11.4.50 Sensor Temperature Packet	195
11.5 Configuration Packets	196
11.5.1 Packet Timer Period Packet	197
11.5.1.1 UTC Synchronisation	197
11.5.1.2 Packet Timer Period	197
11.5.2 Packets Period Packet	197
11.5.2.1 Clear Existing Packets	198
11.5.2.2 Packet Period	198
11.5.3 Baud Rates Packet	199
11.5.3.1 Supported Baud Rate	199
11.5.4 Sensor Ranges Packet	201
11.5.4.1 Accelerometers Range	201
11.5.4.2 Gyroscopes Range	201
11.5.5 Installation Alignment Packet	201
11.5.5.1 Alignment DCM	203
11.5.6 Filter Options Packet	203
11.5.6.1 Vehicle Types	203
11.5.7 GPIO Configuration Packet	204
11.5.7.1 GPIO Functions	205
11.5.7.2 Auxiliary Functions	206
11.5.7.3 GPIO Voltage Selection	208
11.5.8 Magnetic Calibration Values Packet	208
11.5.9 Magnetic Calibration Configuration Packet	209
11.5.9.1 Magnetic Calibration Actions	209
11.5.10 Magnetic Calibration Status Packet	209

11.5.10.1 Magnetic Calibration Status	209
11.5.11 Odometer Configuration Packet	210
11.5.12 Set Zero Orientation Alignment Packet	210
11.5.13 Reference Point Offsets Packet	211
11.5.14 GPIO Output Configuration Packet	212
11.5.14.1 Port Input Modes	213
11.5.14.2 Port Output Modes	213
11.5.14.3 NMEA Fix Behaviour	213
11.5.14.4 Port Output Rates	214
11.5.15 Dual Antenna Configuration Packet	214
11.5.15.1 Offset Types	215
11.5.15.2 Automatic Offset Orientations	215
11.5.16 GNSS Configuration Packet	215
11.5.16.1 Aries GNSS Receiver	215
11.5.16.2 Trimble BD992 GNSS Receiver	216
11.5.16.3 GNSS Frequency Bitfields	216
11.5.16.4 L Band Modes	217
11.5.16.5 L Band Satellite IDs	218
11.5.17 User Data Packet	218
11.5.18 GPIO Input Configuration Packet	219
11.5.19 IP Dataports Configuration Packet	219
11.5.19.1 IP Dataport Mode	219
11.5.20 CAN Configuration Packet	220
11.5.20.1 CAN Protocol	220
12 Reference Information	221
12.1 Technology Overview	221
12.1.1 GNSS	221
12.1.2 AHRS	221
12.1.3 INS	221
12.1.4 GNSS/INS	221
12.2 The Sensor Co-ordinate Frame	222
12.2.1 Right Hand Rule	222
12.3 The Body Co-ordinate Frame	223
12.4 Roll, Pitch and Heading	223
12.4.1 Second Right Hand Rule	223
12.4.2 Rotation Order	224
12.5 Geodetic Co-ordinate System	224
12.5.1 Latitude and Longitude	225
12.5.2 Height	227
12.6 NED Co-ordinate Frame	228
12.7 ECEF Co-ordinate Frame	228

DISCLAIMER

Information in this document is provided solely in connection with Advanced Navigation products. Advanced Navigation reserves the right to make changes, corrections, modifications or improvements, to this document, and the products and services described herein at any time, without notice.

All Advanced Navigation products are sold pursuant to Advanced Navigation's terms and conditions of sale.

Purchasers are solely responsible for the choice, selection and use of the Advanced Navigation products and services described herein, and to the extent permitted by law, Advanced Navigation assumes no liability whatsoever relating to, or in anyway connected to, the choice, selection or use of the Advanced Navigation products and services described herein.

No license, express or implied, by estoppel or otherwise, to any intellectual property rights is granted under this document. If any part of this document refers to any third party products or services it shall not be deemed a license grant by Advanced Navigation for the use of such third party products or services, or any intellectual property contained therein or considered as a warranty covering the use in any manner whatsoever of such third party products or services or any intellectual property contained therein.

UNLESS OTHERWISE SET FORTH IN ADVANCED NAVIGATION'S TERMS AND CONDITIONS OF SALE ADVANCED NAVIGATION DISCLAIMS ANY EXPRESS OR IMPLIED WARRANTY WITH RESPECT TO THE USE AND/OR SALE OF ADVANCED NAVIGATION PRODUCTS INCLUDING WITHOUT LIMITATION IMPLIED WARRANTIES OF MERCHANTABILITY, FITNESS FOR A PARTICULAR PURPOSE (AND THEIR EQUIVALENTS UNDER THE LAWS OF ANY JURISDICTION), FAULT TOLERANCE OR INFRINGEMENT OF ANY PATENT, COPYRIGHT OR OTHER INTELLECTUAL PROPERTY RIGHT.

UNLESS EXPRESSLY APPROVED IN WRITING BY TWO AUTHORIZED ADVANCED NAVIGATION REPRESENTATIVES, ADVANCED NAVIGATION PRODUCTS ARE NOT RECOMMENDED, AUTHORIZED OR WARRANTED FOR USE IN MILITARY, AIR CRAFT, SPACE, LIFE SAVING, OR LIFE SUSTAINING APPLICATIONS OR HAZARDOUS OR HIGH RISK ENVIRONMENTS REQUIRING FAIL-SAFE OR FAULT TOLERANT PERFORMANCE, NOR IN PRODUCTS OR SYSTEMS WHERE FAILURE OR MALFUNCTION MAY RESULT IN PERSONAL INJURY, DEATH, OR SEVERE PROPERTY OR ENVIRONMENTAL DAMAGE. SUCH USE IS AT PURCHASERS OWN RISK, EVEN IF ADVANCED NAVIGATION KNOWS OF SUCH USE.

ADVANCED NAVIGATION PRODUCTS WHICH ARE NOT SPECIFIED AS "AUTOMOTIVE GRADE" MAY ONLY BE USED IN AUTOMOTIVE APPLICATIONS AT USER'S OWN RISK.

Resale of Advanced Navigation products with provisions different from the statements and/or technical features set forth in this document shall immediately void any warranty granted by Advanced Navigation for the Advanced Navigation product or service described herein and shall not create or extend in any manner whatsoever, any liability of Advanced Navigation.

Information in this document supersedes and replaces all information previously supplied. References to Advanced Navigation in this disclaimer includes its related bodies corporate.

Document Version: 2.3 Publication Date: 20 March 2024

For more information, contact technical support via email at support@advancednavigation.com.

© 2024 Advanced Navigation - All rights reserved

1 Revision History

Version	Date	Changes
2.3	20 March 2024	Updated firmware changelog, see 2.1 Firmware Changelog
2.2	5 March 2024	Updated firmware changelog, see 2.1 Firmware Changelog Updated automatic magnetometer calibration explanation to reflect firmware changes, see 8.5 Magnetic Calibration ANPP packets 70 (Raw DVL Data Packet) and 185 (Installation Alignment Packet) updated Minor editorial changes
2.1	15 November 2023	Updated weights and improved detail of 6.3 Hardware Specifications Added 6.3.4.3 Centre of Gravity Location of Certus Removed magnetometer sensor range Expanded topic on 9.2.3 Installation and Starting Updated software changelog, see 9.2.1 Certus Manager Software Changelog
2.0	17 February 2023	Updated software changelog, see 9.2.1 Certus Manager Software Changelog Updated software installation information to include Java 11 requirement, see 9.2.3 Installation and Starting and 7.1 Installation Checklist Updated instructions for running manager on MacOS, see 9.2.3 Installation and Starting
1.9	23 December 2022	Updated hardware changelog, see 2.2 Hardware Changelog Updated firmware changelog, see 2.1 Firmware Changelog
1.8	18 November 2022	Updated firmware changelog, see 2.1 Firmware Changelog Removed note that firmware can only be upgraded using the primary ANPP data port, see 10.6.1.32 ANPP Input and 10.6.1.43 ANPP Output Added information on disabling dual antenna heading for single antenna configurations, see 11.5.6 Filter Options Packet and 9.1.3 Configuration Menu
1.7	20 October 2022	Updated software changelog, see 9.2 Using Certus Manager Updated Logging information as per Manager v6.2, see 9.2.8.5 Log Converter Added inrush current to specifications, see 6.5 Electrical Specifications Added a link to the product page to find the SDK, see 9.4 Using ANPP Updated External Time Packet to show it is Read only, see 11.4.32 External Time Packet Added disclaimer about affected ports for Packets Period Packet, see 11.5.2 Packets Period Packet Separated Licenses from Accessories and updated license part numbers, see 5 Part Numbers and Ordering Options Added disclaimer than some GNSS and Antenna Flags are only applicable to Aries GNSS Receivers, see 9.1.2.4 Status , 11.4.1 System State Packet and 11.4.10 Raw GNSS Packet Updated External Time Packet to show it is Read only, see 11.4.32 External Time Packet

Version	Date	Changes
1.6	20 April 2022	<p>Updated hardware changelog, see 2.2 Hardware Changelog</p> <p>Updated software changelog, see 9.2 Using Certus Manager</p> <p>Updated firmware changelog, see 2.1 Firmware Changelog</p> <p>Updated Device ID table, see 11.3.4 Device Information Packet</p> <p>Added disclaimer that 2D and 3D Magnetic Calibration are not available for Certus Evo, see 8.5 Magnetic Calibration</p> <p>Added automatic calibration information for 3D vehicle profiles, see 8.5 Magnetic Calibration</p> <p>Added Device Discovery section for Certus Manager, see 9.2 Using Certus Manager</p> <p>Updated Logging information to include user configurable Log Path, see 9.2.8.5 Log Converter</p> <p>Reformatted 1PPS Output information, see 10.6.1.2 1PPS Output</p> <p>Added Basestation Packet, see 11.4.47 Basestation Packet</p> <p>Breakout cable diagrams updated to show DC connector size, see 6.7 IO Connection</p> <p>Pin location diagrams added, see 6.6 Connector Pin-out</p> <p>Added additional information to 11.4.39 Raw Satellite Ephemeris Packet</p> <p>Added disclaimer that 11.5.4 Sensor Ranges Packet is invalid for Certus Evo</p> <p>Updated mechanical drawings, see 6.3.4 Rugged Mechanical Drawings</p>
1.5	6 Sept 2021	<p>Migrated documentation platform, various formatting and copy changes</p> <p>Updated Firmware Changelog</p> <p>Updated GNSS Specifications</p> <p>Added information about ANPP packets 13, 14, 85 and 197</p>
1.4	19 Feb 2021	<p>Updated Firmware Changelog</p> <p>Updated Hardware Changelog</p> <p>Update to Navigation specifications</p> <p>Update to GNSS specifications</p>
1.3	13 Jan 2021	<p>Clarified sensor range applicability</p> <p>Updated Firmware Changelog</p> <p>Added reference to OEM variant section</p> <p>Updated Advanced web user interface</p> <p>Fixed packet data tables</p>
1.2	2 Nov 2020	<p>Added note on slip angle value</p> <p>Updated Certus Evo sensor specifications</p>
1.1	23 Sep 2020	<p>Added Trimble BD992 part numbers</p> <p>Corrected navigation specifications</p> <p>Added Trimble BD992 receiver option</p> <p>Updated hardware specifications</p> <p>Clarified connector details</p> <p>Added BD992 packet information</p>
1.0	20 Jan 2020	Initial Release

Table 1: Revision History

2 Introduction

Certus is a next-generation miniature GNSS / INS & AHRS system that provides accurate position, velocity, acceleration and orientation under the most demanding conditions. It combines temperature calibrated accelerometers, gyroscopes, magnetometers and a pressure sensor with a dual antenna RTK GNSS receiver. These are coupled in a sophisticated fusion algorithm to deliver accurate and reliable navigation and orientation.



Figure 1: Certus

Certus will provide outstanding results when mounted, configured and operated correctly. Read through this manual carefully to ensure a successful outcome for your application.

Note: Certus is available in a number of variants. Any reference to Certus can be assumed to refer to either, with any specific exceptions noted.

- Performance: Certus and Certus Evo are available with different MEMS sensors, offering differing levels of Pitch & Roll, and Heading performance.
- Form factor: All references refer to the enclosed (rugged) form factor. See the [OEM documentation](#) for customer integrated units.
- GNSS receiver: the standard GNSS receiver is an Advanced Navigation Aries. A Trimble BD992 variant is also available.

A Certus Evaluation Kit, which includes all the GNSS antennas and cables you will need, is available to get you started quickly. If you have any questions, contact support@advancednavigation.com.

More Information...

Use the links below for detailed information about Certus Evo.

- [5 Part Numbers and Ordering Options](#)
- [6 Specifications](#)
- [7 Installing Certus](#)
- [8 Using Certus](#)
- [9 Configuring and Monitoring Certus](#)

- [10 Interfacing](#)
- [11 Advanced Navigation Packet Protocol](#)
- [12 Reference Information](#)

2.1 Firmware Changelog

Version	Date	Changes
1.81	20 March 2024	Fixed pressure sensor reporting NaN values on v1.3 HW
1.80	1 March 2024	<p>Updated supported L-band satellite frequencies for Trimble receivers</p> <p>Added support for Trimble BD992 receiver with v5.61 and ProPoint v6.21 FW</p> <p>Implemented web UI status display when COCOM limits are removed for Trimble BD9xx receivers</p> <p>Fixed malformed CANOpen packets</p> <p>Added UTM grid position output to the CANOpen protocol</p> <p>Added ANPP80 Basestation packet to web UI</p> <p>Fixed CRC mismatch for bootloader packet acknowledgement</p> <p>Fixed intermittent web UI not accessible on boot up after firmware update</p> <p>Fixed PTP performance impacted by web server load</p> <p>Fixed TCP server issue after using PTP client</p> <p>Improved reliability of Device Discovery</p> <p>Fixed occasional failures when downloading log files</p> <p>Fixed sensor ranges configuration not being reset on factory restore</p> <p>Improved state orientation during turns</p> <p>Improved reliability of onboarding time</p> <p>Fixed Ethernet connection issue after connecting via Manager</p> <p>Extended external GNSS lever arm offset range to 50 m horizontal and 100 m vertical</p> <p>Fixed time filter flicker when using external GNSS</p> <p>Added support to input the Raw DVL Data Packet (packet 70)</p> <p>Updated DVL input to use Odometer Offset</p> <p>Added 8Hz option in NMEA0183 packet rates in the web UI</p> <p>Improved saving of configuration, eliminating potential for corruption</p> <p>Fixed DNS server selection not respected when DHCP is enabled</p> <p>Improved navigation performance when GNSS is denied</p> <p>Updated Aries GNSS receiver firmware to v1.21</p> <ul style="list-style-type: none"> - Improved GNSS operation when transitioning between Fix to No Fix - Improved ANPP29 packet timing - Reduced erroneous reporting of GNSS Fix <p>Updated Certus Evo IMU firmware to v2.4</p>
1.71	23 December 2022	Updated to support v1.3 hardware. Minimum FW version for v1.3 hardware
1.64	18 November 2022	<p>Improved Aries GNSS Receiver performance</p> <p>Added ability to operate as single antenna configuration by disabling dual antenna heading</p> <p>Improved satellite display for BD992 GNSS Receiver</p>

Version	Date	Changes
		<p>Added ability to update firmware using any ANPP dataport</p> <p>Added hardware version check on startup, sending the unit to bootloader if the firmware is incompatible with the hardware</p> <p>Fixed PTP clock syncing issues</p> <p>Added Disk Full error message in the Web UI Logging page and fixed raising Data Overrun status flag instead of Logging Failure when internal logging memory is full</p> <p>Removed Auto DNS option in Network Configuration when not in DHCP mode</p> <p>Fixed error message when saving changes on Dataports web page</p> <p>Fixed inverse reporting of Automatic Dual Antenna offsets when antenna configuration was Left/Right or Right/Left</p> <p>Adjusted ANPP Packet timing to align with UTC seconds</p> <p>Allowed CAN COB-ID to be set outside of valid PDO range</p> <p>Fixed network dataports not closing existing connection when mode is changed</p> <p>Fixed CANopen PDO objects stop transmitting if the bus is broken then restored</p> <p>Allowed setting RTCM Corrections Input function on Aux port via Web UI Dataports page</p> <p>Fixed BD992 variant doesn't show primary sat SNR in web UI table</p> <p>Fixed GNSS passthrough functionality</p> <p>Fixed bug preventing internal logging of GNSS Passthrough data</p> <p>Fixed Manual Initialisation from Web UI</p> <p>Various bug fixes</p>
1.60	29 March 2022	<p>Updated to support v1.2 hardware pressure sensor from sub-component. Minimum FW version for v1.2 hardware</p> <p>Added configuration import/export functionality to web UI</p> <p>Improved stability and performance of automatic magnetometer calibration algorithm for some vehicle profiles, see 8.5 Magnetic Calibration</p> <p>Improved handling of NTRIP server connections</p> <p>Fixed intermittent dropping of network connection</p> <p>Fixed System Failure flag set when powering up the unit after a long period of inactivity</p> <p>Increased limit on NTRIP mount point list</p> <p>Updated available BD992 L Band satellites</p> <p>Fixed Manual Initialisation from Web UI</p> <p>General reliability improvements</p>
1.54	26 November 2021	<p>Improved reliability of saving configuration changes in Web UI</p> <p>Improve GNSS fix type when using RTCM via Aux port</p> <p>Fix time jump after time filter initialisation with BD992 receiver</p> <p>Improve indicator behaviour in Web UI on disconnect/timeout</p> <p>Improve map view on Web UI to update key to latest</p> <p>Fix intermittent filter error, triggered under very rare circumstances</p>
1.53	8 October 2021	<p>Update Certus to support Spatial MEMS IMU hardware v2.2</p> <p>Update Certus Evo to support v2.3 Evo MEMS IMU hardware</p> <p>Add support for Trimble BD992 firmware v5.50</p> <p>Update Aries GNSS Receiver to firmware v1.14</p> <p>Add ability to modify the NodeID used for CANopen</p>

Version	Date	Changes
		<p>Introduced restrictions that prohibit configuring a TX PDO as an SDO COB-ID</p> <p>System Status 'Low Voltage Alarm' bit redefined as 'Internal Data Logging Error'</p> <p>Fix GPIO 1PPS Out of sync</p> <p>Fix CAN output to support data rates up to 100 Hz</p> <p>Fix NMEA 0183 GPGSV output missing</p> <p>Fix unable to turn off SBAS on BD992 GNSS receiver</p> <p>Improved dedicated 1PPS to always output</p> <p>Improve SBAS Fix reliability</p> <p>Improve PTP timing accuracy</p>
1.51	16 July 2021	<p>Various Web UI improvements and fixes</p> <p>Add Packet 61 (Raw Ephemeris Packet)</p> <p>Update Aries GNSS Receiver to firmware v1.13</p> <p>Fix 3D magnetic calibration not working</p> <p>Update Certus Evo to support v2.2 sensor firmware</p> <p>Fixed network failure after several network cable reconnections</p> <p>Fix logging issue on OEM variants</p>
1.49	13 April 2021	<p>Several bug fixes</p> <p>Added ability to set Omnistar frequencies to the Web UI</p> <p>Added GNSS Configuration page</p> <p>Updated Aries GNSS Receiver to firmware v1.12</p> <p>Packet rate updated to reflect GNSS Sample Rate</p> <p>General stability improvements</p>
1.47	15 February 2021	<p>Improve navigation performance when using antenna offsets</p>
1.46	6 January 2021	<p>Add body velocity packet to CANopen dictionary</p>
1.45	23 December 2020	<p>Update for PCB revision for Certus OEM support. Minimum version for v1.1 hardware.</p> <p>Add ability to set all CAN rates</p>
1.44	15 December 2020	<p>Update to support latest Certus Evo sensor hardware</p>
1.43	9 November 2020	<p>Various bug fixes</p> <p>Packet 60 is limited to 10 Hz output for both GNSS receivers (note that the packet rates can only be set to 10Hz).</p>
1.42	29 October 2020	<p>Various bug fixes</p> <p>Update Aries GNSS Receiver to firmware v1.10</p>
1.41	8 October 2020	<p>Fix Artificial Horizon (Web UI) doesn't show Airspeed or Altitude</p> <p>Update Aries GNSS Receiver to firmware v1.09</p>
1.40	4 September 2020	<p>Packet 60 is limited to 10 Hz output for both GNSS receivers (note that the packet rates can only be set to 10 Hz)</p> <p>Update Aries GNSS Receiver to firmware v1.08.</p> <p>Update Aries 20 Hz packet rates to 10 Hz</p>
1.39	28 August	<p>Fix IP configuration packet does not update the IP when a DHCP lease is</p>

Version	Date	Changes
	2020	renewed. Fix packet 192 is not serviced correctly in the Web UI. Feature add support BD992 (firmware v5.37).
1.38	18 August 2020	Update Aries GNSS Receiver to firmware v1.07. Fix Certus does not report filter options correctly in the web UI. Fix can't save user data. Fix comms errors on network data port with GNSS passthrough Fix repeated connect/disconnect on dataport causes networking to crash on Certus Fix magnetometer temperature not populated correctly Fix TCP server drops connections while connected
1.37	8 July 2020	Feature to add status reporting to log page. Update Aries GNSS Receiver to firmware v1.06. Improved NTRIP client should automatically determine if it needs to transmit position.
1.36	26 June 2020	Fix system time jumps back 15 s when no antenna plugged in Fix setting network configuration using multi-cast fails Fix Primary and Aux not setting RS232, RS422 Mode
1.35	18 June 2020	Fix issue when setting sensor ranges NTRIP client improvements Timing improvements to non-ANPP packet outputs eg NMEA messages Website will warn when packet rates are too high for the current baud rate UTC Time on website now displayed with the alphanumerical month to avoid confusion
1.34	10 June 2020	Include sub-component firmware with Certus firmware Add serial data inputs to data ports Improvements to logging functionality Improvements to NTRIP client
1.33	22 May 2020	Packet 60 now sets the overflow fault if it can't be sent out of any port Dual antenna configuration packet now reports the baseline if set to automatic Add packet 85 (sensor temperatures) support to the web UI and serial/data ports. Fix configuration packets not being correctly saved at the beginning of a log. Packet timing improved Add magnetometer calibration web page Allow all serial inputs to be used in the data ports
1.32	11 May 2020	Fix bug in web server causing system crash 1PPS Output defaults to GNSS 1PPS instead of Certus' internal generated 1PPS.
1.31	30 April 2020	Fix Certus Evo pressure sensor Remove 1PPS synchronisation from Packet Timer - packets now output at the correct rate. Causes, packets are no longer synchronised to UTC. Fix to populate the CAN state data
1.30	10 Apr 2020	Add NTRIP client Improve packet 60 output

Version	Date	Changes
		Improve on-board logging reliability Improve RTCM serial input
1.21	5 Mar 2020	Minor user interface improvements
1.20	28 Feb 2020	Add Certus Evo support Add subcomponent Information to View menu Add ANPP packet 60 output functionality Add RTCM serial input functionality
1.10	11 Feb 2020	Activate logging functionality.
1.02	31 Jan 2020	Allow network settings to be updated without reboot. Ensure mDNS can handle multiple Certus devices on a network. Support packet 84 in data ports.
1.00	10 Jan 2020	Initial release

Table 2: Firmware Changelog

2.2 Hardware Changelog

Version	Date	Changes
1.3	02 June 2022	Baseboard update to improve manufacturing
1.2	23 July 2021	Updated Magnetometers Updated pressure sensor Updated IMU (Certus only, not applicable to Certus Evo) Mechanical design for manufacture change to improve assembly
1.1	15 December 2020	Update to support OEM
1.0	10 January 2020	Initial release

Table 3: Hardware Changelog

3 Rugged Evaluation Kit

The Certus Rugged variant is supplied in an Evaluation Kit that contains everything required to get started operating the system right away. The Evaluation Kit is supplied in a rugged transport case to protect the equipment during transit.



Figure 2: Certus Rugged Evaluation Kit transport case

3.1 Rugged Evaluation Kit Contents



Figure 3: Certus Rugged Evaluation Kit Contents

Part Number	Quantity	Description	Notes
CERTUS, CERTUS-EVO, CERTUS-BD992 or CERTUS-EVO- BD992	1	Certus GNSS/INS or Certus Evo GNSS/INS	Certus unit in rugged enclosure with either Aries or Trimble BD992 Receiver
G5ANT-53A4T1	2	Antcom GNSS antennas	Antcom L1/L2/L5 GNSS antennas with 5/8"-11 survey mounts
BF046WS180427- 03	2	GNSS antenna cable 4 m	4 m RG58/U antenna cables with SMA to TNC connectors
CABLE-PPC-16- BREAKOUT	1	Cable push-pull circular 16 pin breakout 2 m	2 m 16 pin IO breakout cable. See 6.7 IO Connection
CABLE-PPC-8- BREAKOUT	1	Cable push-pull circular 8 pin breakout 2 m	2 metre 8 pin IO breakout cable. See 6.7.1 8 Pin IO Breakout Cable
CABLE-FTDI	1	USB to RS232 / RS422 cable 1 m	1 m FTDI USB to RS232 / RS422 (select- able) cable
PPC-DUSTCAP	1	Blanking cap push-pull circular	Blanking cap for the Certus connectors
SUPPLY-24V	1	24 V DC Power Supply	100-240 V AC Mains to 24 V DC Power Supply (DC jack) Includes 2-pin plug types A/C/G/I
CERTUS-EK-CASE	1	Certus Evaluation Kit case	Rugged transport case

Table 4: Rugged Evaluation Kit Contents

4 Getting Started

1. Plug the 8 pin interface cable into the IO1 connector on the Certus.
2. Connect an Ethernet cable from the Ethernet socket on the breakout cable to your network or router.
3. Plug the power supply into the power connector on the breakout cable and then into the wall socket.
4. Download and install the Bonjour ZeroConf networking utility from the link <https://www.advancednavigation.com/Bonjour64.msi>.
5. In a web browser, type in the address <http://certus.local>

There are additional factors that you must review before you proceed with the installation. For more information, see [7 Installing Certus](#)

5 Part Numbers and Ordering Options

This section covers information about:

- [5.1 Evaluation Kits](#)
- [5.2 Standalone Units](#)
- [5.4 GNSS Receiver License Upgrades](#)
- [5.5 Accessories](#)

5.1 Evaluation Kits

Part Number	Description	Notes
CERTUS-EK	Certus Rugged Evaluation Kit	Certus Rugged Aries GNSS Evaluation Kit Includes the items listed in 3.1 Rugged Evaluation Kit Contents .
CERTUS-EVO-EK	Certus Evo Rugged Evaluation Kit	Certus Evo Rugged Aries GNSS Evaluation Kit Includes the items listed in 3.1 Rugged Evaluation Kit Contents .
CERTUS-BD992-EK	Certus BD992 Rugged Evaluation Kit	Certus Rugged BD992 GNSS Evaluation Kit Includes the items listed in 3.1 Rugged Evaluation Kit Contents .
CERTUS-EVO-BD992-EK	Certus Evo BD992 Rugged Evaluation Kit	Certus Evo Rugged BD992 Evaluation Kit Includes the items listed in 3.1 Rugged Evaluation Kit Contents .

Table 5: Evaluation Kit Part Numbers

5.2 Standalone Units

Part Number	Description	Notes
CERTUS	Certus Rugged Unit	Certus unit in rugged enclosure Aries GNSS Receiver GPS, GLONASS, BeiDou and Galileo 1 cm RTK No cables or blanking caps included
CERTUS-EVO	Certus Evo Rugged Unit	Certus Evo unit in rugged enclosure Aries GNSS Receiver GPS, GLONASS, BeiDou and Galileo 1 cm RTK No cables or blanking caps included
CERTUS-BD992	Certus Rugged BD992 Unit	Certus unit in rugged enclosure Trimble BD992 GNSS Receiver GPS, GLONASS, L-band constellations 30cm RTK No cables or blanking caps included
CERTUS-EVO-BD992	Certus Evo Rugged BD992 Unit	Certus Evo unit in rugged enclosure Trimble BD992 GNSS Receiver GPS, GLONASS, L-band constellations 30cm RTK No cables or blanking caps included

Table 6: Standalone Unit Part Numbers

5.3 Antennas

The antennas listed below are available for purchase. For more information on antenna selection, see [7.5 GNSS Antennas](#) for more details.

Part Number	Description	Notes
Cables		
BF046WS180427-03	GNSS antenna cable 4 m	4 m RG-58A/U SMA male to TNC male
Antennas		
G5ANT-53A4T1	Antcom GNSS Antenna	Antcom G5 L1/L2/L5 GNSS antenna with survey mount, TNC Female connector Use with BF046WS180427-03
VSP6337L	Tallysman VeroStar GNSS Antenna	VeroStar GNSS Antenna - L1/L2/L5 plus L-band, pole mount, TNC Female connector Use with BF046WS180427-03
Antenna Accessories		
MOUNT-SUCT	Suction Cup Antenna Mount	Suction cup 5/8" GNSS antenna survey mount for easy installation of GNSS antenna on vehicles

Figure 4: Antenna Part Numbers

5.4 GNSS Receiver License Upgrades

These licenses are only applicable to units with a Trimble BD992 GNSS Receiver.

Part Number	Description	Notes
BD992-LIC-10CM	Upgrade Certus BD992 to 10cm RTK	Applicable for Trimble BD992 GNSS Receiver variant
BD992-LIC-8MM	Upgrade Certus BD992 to full RTK (8mm) with Galileo and BeiDou	Applicable for Trimble BD992 GNSS Receiver variant Adds Galileo and BeiDou constellations

Table 7: Ordering Part Numbers for GNSS Receiver Licence Upgrades

5.5 Accessories

Part Number	Description	Notes
CABLE-PPC-16-BREAKOUT	Cable push-pull circular 16 pin breakout 2 m	Certus 2 m breakout cable with 16-pin plug and breakout connectors. See 6.7 IO Connection
CABLE-PPC-8-BREAKOUT	Cable push-pull circular 8 pin breakout 2 m	Certus 2 m breakout cable with 8-pin plug and breakout connectors. See 6.7 IO Connection
CABLE-PPC-16-UNT-3M	Cable push-pull circular 16 pin unterminated 3 m	Certus 3 m cable with 16-pin plug and unterminated connectors. See 6.6 Connector Pin-out

Part Number	Description	Notes
CABLE-PPC-16-UNT-10M	Cable push-pull circular 16 pin unterminated 10 m	Certus 10 m cable with 16-pin plug and unterminated connectors. See 6.6 Connector Pin-out
CABLE-PPC-8-UNT-3M	Cable push-pull circular 8 pin unterminated 3 m	Certus 3 m cable with 8-pin plug and unterminated connectors. See 6.6 Connector Pin-out
CABLE-PPC-8-UNT-10M	Cable push-pull circular 8 pin unterminated 10 m	Certus 10 m cable with 8-pin plug and unterminated connectors. See 6.6 Connector Pin-out
PPC-DUSTCAP	Blanking cap	Blanking cap for the Certus connectors
CABLE-FTDI	USB to RS232 / RS422 cable 1 m	FTDI USB to RS232 / RS422 (selectable) 1 m cable
SUPPLY-24V	24V DC Power Supply	100-240 V AC Mains to 24 V DC Power Supply (DC jack) Includes 2-pin plug types A/C/G/I
CAR12VPWR	Car auxiliary power outlet supply	Car auxiliary power supply to DC jack power supply
OBDII-ODOMETER	OBDII Odometer	See 7.7.2 OBDII Odometer Interface
Various Air Data Units	Air Data Unit	Air data unit provides pitot and static air velocity data aiding for Certus in fixed wing aircraft

Table 8: Accessories Part Numbers

6 Specifications

For details, review the following specifications for Certus:

- [6.1 Navigation Specifications](#)
- [6.2 Sensor Specifications](#)
- [6.3 Hardware Specifications](#)
- [6.4 Communication Specifications](#)
- [6.5 Electrical Specifications](#)
- [6.6 Connector Pin-out](#)
- [6.7 IO Connection](#)

6.1 Navigation Specifications

6.1.1 Certus Specifications

Parameters	Specification	
	Aries GNSS Receiver	Trimble BD992 Receiver
Horizontal Position Accuracy	1.2 m	
Vertical Position Accuracy	2.0 m	
Horizontal Position Accuracy (SBAS)	0.5 m	
Vertical Position Accuracy (SBAS)	0.8 m	
Horizontal Position Accuracy (RTK or Kinematica Post Processing)	0.01 m	0.008 m
Vertical Position Accuracy (RTK or Kinematica Post Processing)	0.015 m	
Velocity Accuracy	0.05 m/s	0.007 m/s
Roll & Pitch Accuracy	0.1 °	
Heading Accuracy (1.0 m antenna separation)	0.1 °	
Roll & Pitch Accuracy (Kinematica Post Processing)	0.03 °	
Heading Accuracy (Kinematica Post Processing)	0.06 °	
Slip Accuracy	0.1 °	
Heave Accuracy	5 % or 0.05 m	
Orientation Range	Unlimited	
Hot Start Time	500 ms	
Internal Filter Rate	1000 Hz	
Output Data Rate	Up to 1000 Hz	

Table 9: Certus Navigation Specifications

6.1.2 Certus Evo Specifications

Parameter	Specification	
	Aries GNSS Receiver	Trimble BD992 Receiver
Horizontal Position Accuracy	1.2 m	
Vertical Position Accuracy	2.0 m	
Horizontal Position Accuracy (SBAS)	0.5 m	
Vertical Position Accuracy (SBAS)	0.8 m	
Horizontal Position Accuracy (RTK or Kinematica Post Processing)	0.01 m	0.008 m
Vertical Position Accuracy (RTK or Kinematica Post Processing)	0.015 m	
Velocity Accuracy	0.05 m/s	0.007 m/s
Roll & Pitch Accuracy	0.03 °	
Heading Accuracy (1 m antenna separation)	0.05 °	
Roll & Pitch Accuracy (Kinematica Post Processing)	0.01 °	
Heading Accuracy (Kinematica Post Processing)	0.01 °	
Slip Accuracy	0.1 °	
Heave Accuracy	5 % or 0.05 m	
Orientation Range	Unlimited	
Hot Start Time	500 ms	
Internal Filter Rate	1000 Hz	
Output Data Rate	Up to 1000 Hz	

Table 10: Certus Evo Navigation Specifications

6.1.3 Heading Accuracy

Antenna Separation	Certus Accuracy	Certus Evo Accuracy
0.5 m	0.16 °	0.12 °
1 m	0.1 °	0.05 °
2 m	0.07 °	0.02 °
5 m	0.05 °	0.01 °
10 m	0.02 °	0.005 °

Table 11: Heading Accuracy

6.2 Sensor Specifications

6.2.1 Certus Specifications

Parameter	Accelerometers	Gyroscopes	Magnetometers	Pressure
Range (dynamic)	±2 g ±4 g ±16 g	±250 °/s ±500 °/s ±2000 °/s	±8 G	10 to 120 KPa
Bias Instability	20 ug	3 °/hr	-	10 Pa
Initial Bias	< 5 mg	< 0.2 °/s	-	< 100 Pa
Initial Scaling Error	< 0.06 %	< 0.04 %	< 0.07 %	-
Scale Factor Stability	< 0.06 %	< 0.05 %	< 0.09 %	-
Non-linearity	< 0.05 %	< 0.05 %	< 0.08 %	-
Cross-axis Alignment Error	< 0.05 °	< 0.05 °	0.05 °	-
Noise Density	100 ug/√Hz	0.004 °/s/√Hz	210 uG/√Hz	0.56 Pa/√Hz
Bandwidth	400 Hz	400 Hz	110 Hz	50 Hz

Table 12: Certus Sensor Specifications

6.2.2 Certus Evo Specifications

Parameter	Accelerometers	Gyroscopes	Magnetometers	Pressure
Range (dynamic)	±10 g	±475 °/s	±8 G	10 to 120 KPa
Bias Instability	8 ug	0.2 °/hr	-	10 Pa
Initial Bias	< 0.45 mg	< 3 °/hr	-	< 100 Pa
Initial Scaling Error	< 0.03 %	< 0.02 %	< 0.07 %	-
Scale Factor Stability	< 0.04 %	< 0.03 %	< 0.09 %	-
Non-linearity	< 0.05 %	< 0.03 %	< 0.08 %	-
Cross-axis Alignment Error	< 0.05 °	< 0.05 °	0.05 °	-

Parameter	Accelerometers	Gyroscopes	Magnetometers	Pressure
Noise Density	2 ug/ $\sqrt{\text{Hz}}$	6 °/hr/ $\sqrt{\text{Hz}}$	210 uG/ $\sqrt{\text{Hz}}$	0.56 Pa/ $\sqrt{\text{Hz}}$
Bandwidth	250 Hz	200 Hz	110 Hz	50 Hz

Table 13: CertusEvo Sensor Specifications

6.2.3 GNSS Specifications

Parameter	Specification	
	Aries GNSS Receiver	Trimble BD992 Receiver
Supported Navigation Systems	GPS L1, L2 GLONASS L1, L2 Galileo E1, E5b BeiDou B1, B2	GPS L1, L2, L5 GLONASS L1, L2 Galileo E1, E5b, E5a ² BeiDou B1, B2, B3 ²
Supported SBAS Systems	WAAS EGNOS MSAS GAGAN QZSS	WAAS EGNOS MSAS GAGAN QZSS Omnistar ¹ Trimble RTX ¹
RTCM Input	Version 3.3	Version 3.2
Update Rate	Up to 20 Hz ³	20 Hz
Hot Start First Fix	2 s	2 s
Cold Start First Fix	30 s	30 s
Horizontal Position Accuracy	1.2 m	1.2 m
Horizontal Position Accuracy (with SBAS)	0.5 m	0.5 m
Horizontal Position Accuracy (with RTK)	0.010 m	0.008 m ²
Velocity Accuracy	0.05 m/s	0.007 m/s
Timing Accuracy	20 ns	20 ns
Acceleration Limit	4 g	11 g

Table 14: GNSS Specifications

¹ Requires purchase of Omnistar or Trimble RTX subscription

² Requires purchase of additional software license, see [5.4 GNSS Receiver License Upgrades](#)

³ See [9.1.3.16 GNSS Configuration](#) for update rate relevant to particular constellation configurations

6.3 Hardware Specifications

6.3.1 Certus Hardware Specifications

Parameter	Specification	
	Aries GNSS Receiver	Trimble BD992 Receiver
Weight	250 grams	280 grams
Dimensions	78 x 115 x 34 mm	
Hot Start Battery Capacity	> 48 hours	
Hot Start Battery Endurance	> 10 years	
Mean Time between Failure (MTBF)	140,000 hours	

Table 15: Hardware Specifications for Certus Rugged Variant

6.3.2 Certus Evo Hardware Specifications

Parameter	Specification	
	Aries GNSS Receiver	Trimble BD992 Receiver
Weight	310 grams	340 grams
Dimensions	78 x 115 x 44 mm	
Hot Start Battery Capacity	> 48 hours	
Hot Start Battery Endurance	> 10 years	
Mean Time between Failure (MTBF)	140,000 hours	

Table 16: Hardware specifications for Certus Evo Rugged Variant

6.3.3 Certus and Certus Evo Environmental Specifications

Parameter	Specification	Standard
Operating and Storage Temperature	-40 °C to 85 °C	MIL-STD-810H Method 501.7 & 502.7
Humidity	Natural Cycle B1	MIL-STD-810H Method 507.6
Salt Fog	48 hours	MIL-STD-810H Method 509.7
Ingress Protection	IP67	IEC 60529 MIL-STD-810H Method 512.6
Vibration	7.7 g rms	MIL-STD-810H Method 514.8E-1 & 514.8C-3
Shock	40 g 11 ms 150 g 6 ms	MIL-STD-810H Method 516.8

Table 17: Environmental specifications for Certus and Certus Evo Rugged Variants

6.3.4 Rugged Mechanical Drawings

6.3.4.1 Certus Rugged Mechanical Drawings

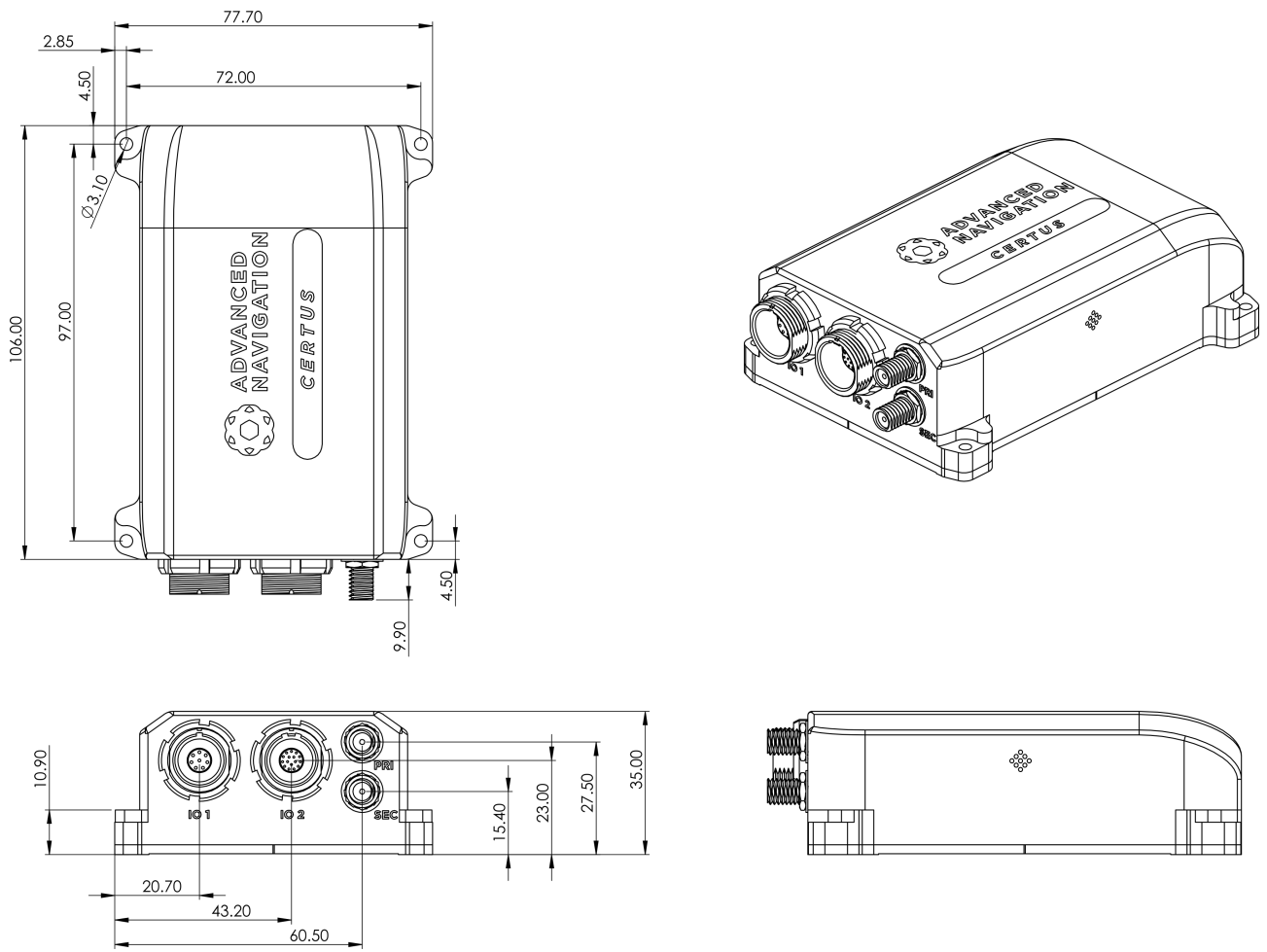

Figure 5: Mechanical drawings of Certus

6.3.4.2 Certus Evo Rugged Mechanical Drawings

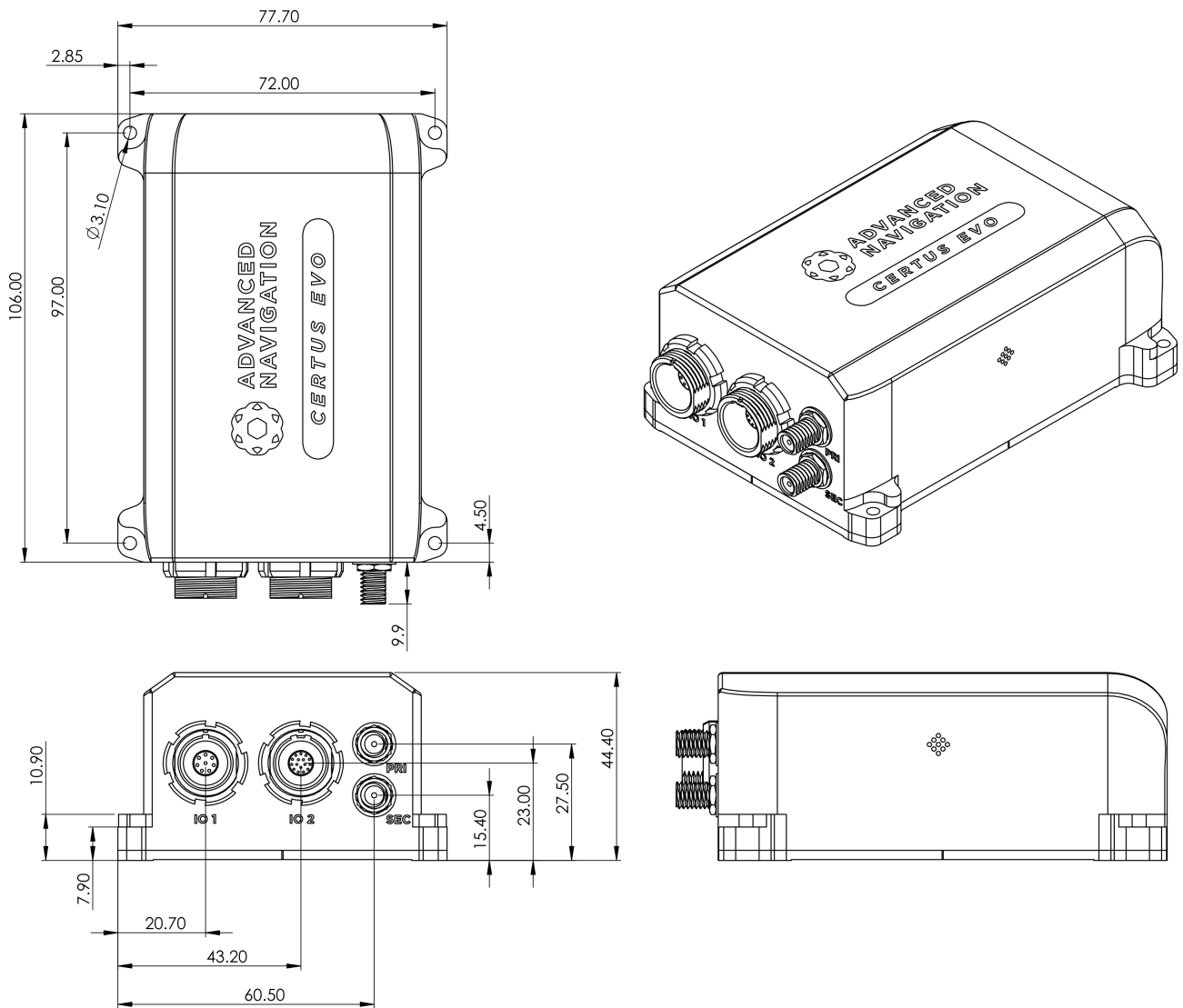

Figure 6: Mechanical Drawings of Certus Evo

6.3.4.3 Centre of Gravity Location of Certus

Parameter	Specification (in mm ± 0.5 mm)	
	Aries GNSS Receiver	Trimble BD992 Receiver
x	59.8	62.1
y	39.5	39.4
z	17.2	16.2

Table 18: Center of Gravity Measurements for Certus Rugged Variant

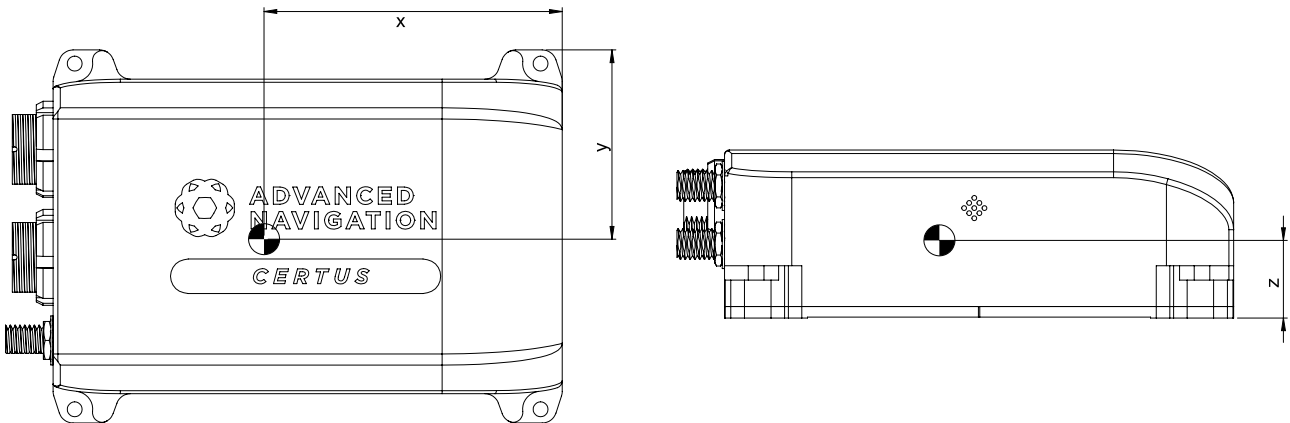

Figure 7: Centre of Gravity of Certus

6.3.4.4 Centre of Gravity Location of Certus Evo

Parameter	Specification (in mm ± 0.5 mm)	
	Aries GNSS Receiver	Trimble BD992 Receiver
x	57.8	59.9
y	40.2	40.1
z	21.1	19.9

Table 19: Center of Gravity Measurements for Certus Evo Rugged Variant

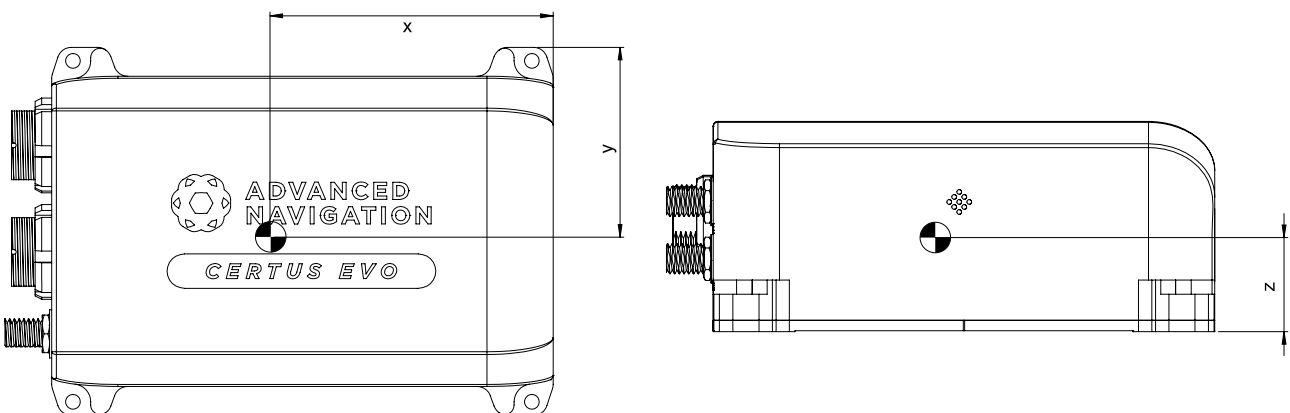

Figure 8: Centre of Gravity of Certus Evo

6.3.5 Serial Number

Units can be identified and tracked using the device serial number. This can be observed in a numbers of ways:

- Through the Device Information page in the web UI ([9.1.2 View Menu](#))
- Through the Device Information page in the [9.2 Using Certus Manager](#) application.
- Via the 2D data matrix bar code on the outside rear of the enclosure. Applications are available for most smart-phones that can scan the 2D data matrix bar code to display the serial number. The label also contains the hardware version and build date.



Figure 9: Certus External Serial Number Sticker

6.4 Communication Specifications

Parameter	Value
Interfaces	Ethernet RS232/RS422 CAN
Speed	100 Mbit (Ethernet) 4800 to 4 M baud (RS232/RS422) 125000 to 1 M baud (CAN)
Protocols	AN Packet Protocol NMEA 0183 NMEA 2000
Peripheral Interface	2 x GPIO for serial, timing, digital inputs/ outputs
GPIO Operating Voltage Levels	3.3 V 5 V RS232
GPIO Port Serial Interface	RS232
GPIO Port Serial Speed	4800 to 250 K baud
Default Primary, Auxiliary, GPIO Serial Speed	115200 baud

Table 20: Communication Specifications for Rugged Variants

6.5 Electrical Specifications

Parameter	Minimum	Typical	Maximum
Operating Voltage	9 V		36 V
Input Protection	-40 V		+100 V
Power Consumption		Certus 2.64 W Certus Evo 2.9 W	Certus 4.5 W Certus Evo 5.0 W
Inrush Current		1.5 A at 12 V	
RS232			
Tx Voltage Low		-5.4 V	-5 V
Tx Voltage High	5 V	5.4 V	
Tx Short Circuit Current			±60 mA
Rx Threshold Low	0.6 V	1.2 V	
Rx Threshold High		1.5 V	2.0 V
RS422			
Tx Differential Output	1.5 V		
Tx Short Circuit Current			±250 mA
Rx Differential Threshold	-0.2 V		-0.05 V
GPIO when set to 5 V			
Output Voltage Low	0 V		0.3 V
Output Voltage High	4.8 V		5 V
Input Voltage	-20 V		20 V
Input Threshold Low			1.5 V
Input Threshold High	3.5 V		
Output Current			5 mA
1PPS when set to 5 V			
Output Voltage Low	0 V		0.3 V
Output Voltage High	4.5 V		5 V
Output Current			50 mA
GPIO when set to 3.3 V			
Output Voltage Low	0 V		0.3 V
Output Voltage High	3 V		3.3 V
Output Current			5 mA
Input Voltage	-5 V		5 V
Input Threshold Low			0.8 V

Parameter	Minimum	Typical	Maximum
Input Threshold High	2 V		
1PPS when set to 3.3 V			
Output Voltage Low	0 V		0.1 V
Output Voltage High	3 V		3.3 V
Output Current			50 mA
GNSS Antenna			
Active Antenna Supply Voltage	4.5 V		4.6 V
Antenna Supply Current			200 mA

Table 21: Electrical Specifications

6.6 Connector Pin-out

Power supply and signal connections are made through the two push-pull type connector – one has 8 pins, the other has 16 pins. The connectors provide reliable and rugged connections to Certus under demanding conditions and are rated to IP67 in the mated position.

Advanced Navigation produces tested cable assemblies as either a breakout cable (see [6.7.1 8 Pin IO Breakout Cable](#) and [6.7.2 16 Pin IO Breakout Cable](#)), or a 3 metre or 10 metre unterminated cable (see [5 Part Numbers and Ordering Options](#)). Advanced Navigation supplied cable assemblies are shielded TPE cable, with each individual wire colour-coded FEP coated 24 AWG wire (for the 8 pin cable) or 28 AWG wire (for the 16 pin cable).

If sourcing and assembling your own cables, the connectors are interchangeable across different manufacturers as detailed below:

Connector	Manufacturer & Series	Part Number	Notes
8 pin circular pushpull connector plug	LEMO K	FGG.1K.308.CLAC60Z	Size 1 1 key
	ODU MINI-SNAP K	S11K0C-P08MFG0-6000	
	Amphenol FLO K	FLKC-08FGMS-GCP-213	
16 pin circular pushpull connector plug	LEMO K	FGA.1K.316.CLAC60Z	Size 1 2 key
	ODU MINI-SNAP K	S11KAC-P16MCC0-6000	
	Amphenol FLO K	FLKC-16FGMS-ACP-213	

Note: Both of the two connectors have a power supply connection. Only one of these power supplies should be connected. Connecting two different power supplies could result in damage to the unit.

Certus features galvanic isolation between different pins to prevent interference. This means that there are different grounds that apply for different pins. See [7.4 Electrical Domains](#) for more information on the different ground domains.

6.6.1 8 Pin Connector

See [Figure 11: 8 Pin Harness connector pin locations](#) below for pin locations. The image is a pin side view, meaning a view looking into the pins on the harness connector.

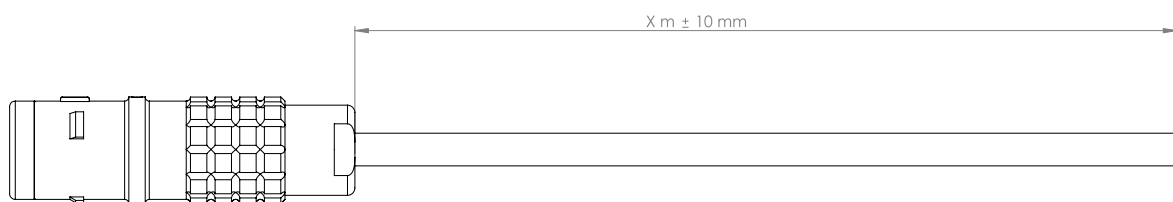

Figure 10: 8 Pin Plug with Unterminated Connectors

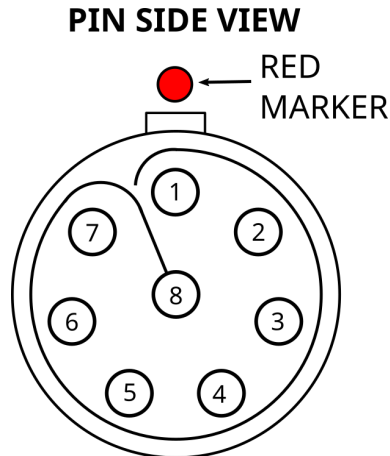

Figure 11: 8 Pin Harness connector pin locations

Pin	Colour	Function
1	Black	Power Ground (see 7.4 Electrical Domains)
2	Red	Power Supply
3	Grey / Black Stripe	1PPS
4	White / Green Stripe	Ethernet T+
5	Green	Ethernet T-
6	White/Orange Stripe	Ethernet R+
7	Orange	Ethernet R-
8	Grey	1PPS (GPIO) Ground (see 7.4 Electrical Domains)
Housing	Cable Braided Shield	Chassis Ground (see 7.4 Electrical Domains)

Table 22: Pin Allocation for 8 Pin Connector

6.6.2 16 Pin Connector

See [Figure 13: 16 Pin Harness connector pin locations](#) below for pin locations. The image is a pin side view, meaning a view looking into the pins on the harness connector.

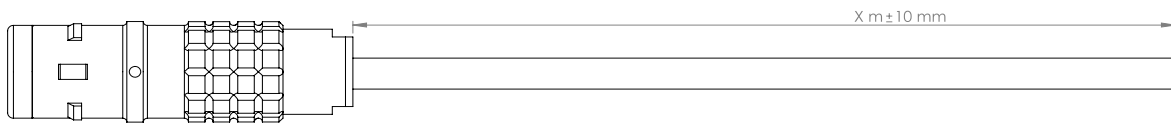

Figure 12: Certus 16 pin plug with Unterminated Connectors

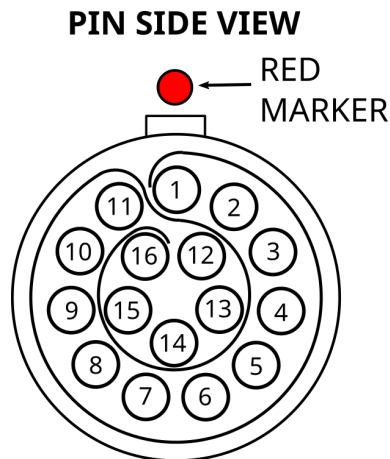

Figure 13: 16 Pin Harness connector pin locations

Pin	Colour	Function
1	Black	Power Ground (see 7.4 Electrical Domains)
2	Red	Power Supply
3	Violet	Primary RS422 Tx+ / RS232 Tx
4	Violet / Black Stripe	Primary RS422 Tx-
5	Yellow	Primary RS422 Rx+ / RS232 Rx
6	Yellow / Black Stripe	Primary RS422 Rx-
7	Light Brown	CAN L
8	Light Brown / Black Stripe	CAN H
9	Blue	GPIO 1
10	Grey	GPIO Ground (see 7.4 Electrical Domains)
11	Brown	GPIO 2
12	Light Blue	Auxiliary RS422 Tx+ / RS232 Tx
13	Light Blue / Black Stripe	Auxiliary RS422 Tx-
14	Light Green	Auxiliary RS422 Rx+ / RS232 Rx
15	Light Green/Black Stripe	Auxiliary RS422 Rx-
16	White	Serial Ground (see 7.4 Electrical Domains)
Housing	Cable Braided Shield	Chassis Ground (see 7.4 Electrical Domains)

Table 23: Pin Allocation for 16 Pin Connector

6.7 IO Connection

Advanced Navigation offers two pre-terminated IO breakout cables (one for the 8 pin connector and one for the 16 pin connector) for quick connection to Certus. All external signal and power connections are 2m long. The evaluation IO breakout cables are supplied as part of the Certus Evaluation Kit. See [3 Rugged Evaluation Kit](#).

Custom cable lengths are not available for pre-terminated cables.

Note: Both the connectors have a power supply connection. Only one of these power supplies should be connected. Connecting two different power supplies could result in damage to the unit.

6.7.1 8 Pin IO Breakout Cable

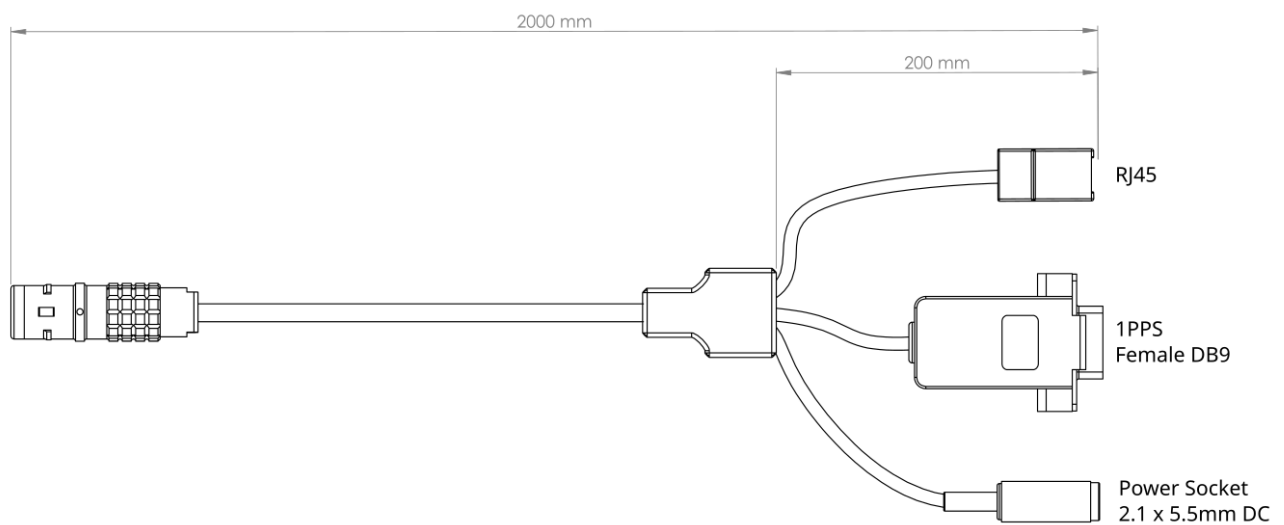

Figure 14: Certus 8 pin IO Breakout Cable

Pin	Function	RJ45	1PPS	Power
1	Power Ground	-	-	Ring
2	Power Supply	-	-	Tip
3	1PPS	-	2	-
4	Ethernet T+	1	-	-
5	Ethernet T-	2	-	-
6	Ethernet R+	3	-	-
7	Ethernet R-	6	-	-
8	1PPS (GPIO) Ground	-	5	-
Housing	Chassis Ground	-	-	-

Table 24: Certus 8 Pin IO Breakout Cable Connector Pin-out

6.7.2 16 Pin IO Breakout Cable

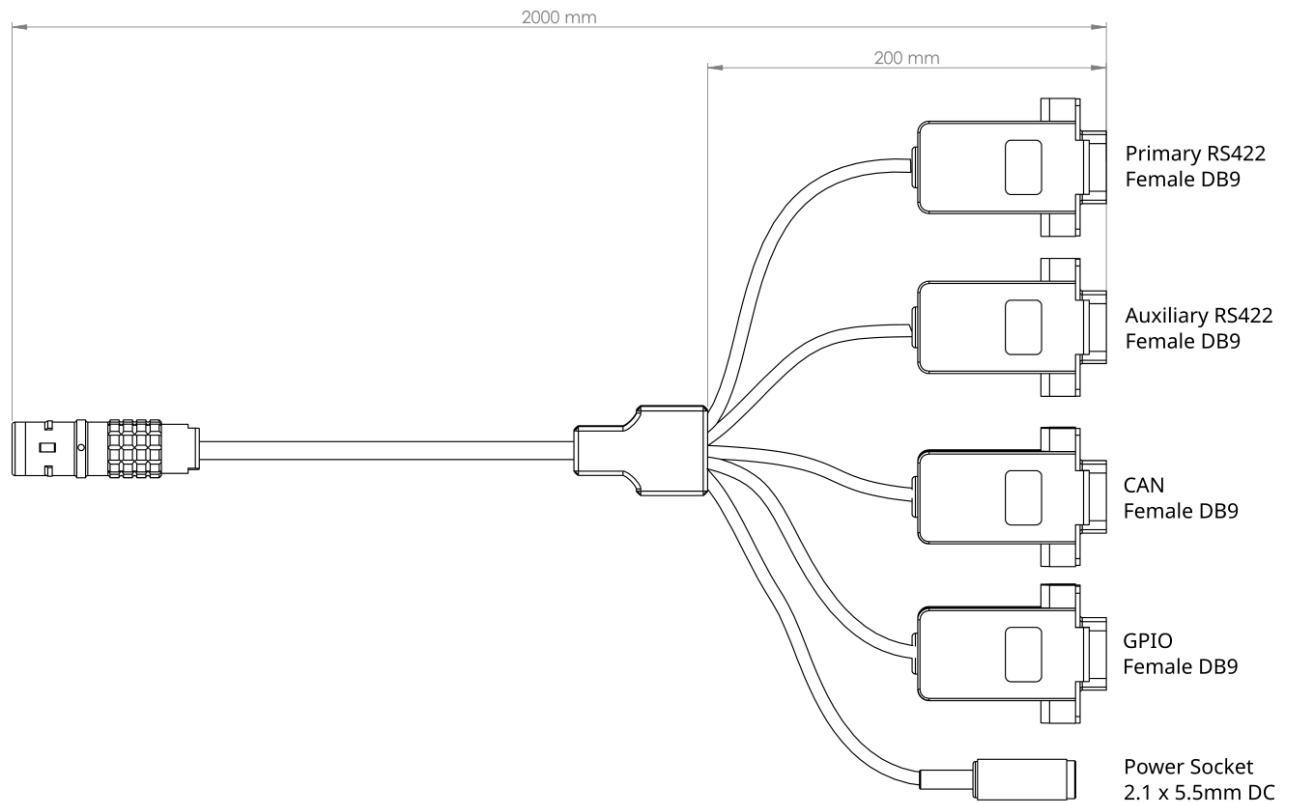

Figure 15: Certus 16 pin IO Breakout Cable

Pin	Function	Primary	Auxiliary	CAN	GPIO	Power
1	Power Ground	-	-	-	-	Ring
2	Power Supply	-	-	-	-	Tip
3	Primary RS422 Tx+ / RS232 Tx	2	-	-	-	-
4	Primary RS422 Tx-	8	-	-	-	-
5	Primary RS422 Rx+ / RS232 Rx	3	-	-	-	-
6	Primary RS422 Rx-	7	-	-	-	-
7	CAN L	-	-	2	-	-
8	CAN H	-	-	7	-	-
9	GPIO 1	-	-	-	2	-
10	GPIO Ground	-	-	-	5	-
11	GPIO 2	-	-	-	3	-
12	Auxiliary RS422 Tx+ / RS232 Tx	-	2	-	-	-

Pin	Function	Primary	Auxiliary	CAN	GPIO	Power
13	Auxiliary RS422 Tx-	-	8	-	-	-
14	Auxiliary RS422 Rx+ / RS232 Rx	-	3	-	-	-
15	Auxiliary RS422 Rx-	-	7	-	-	-
16	Serial Ground	5	5	6	-	-
Housing	Chassis Ground	-	-	-	-	-

Table 25: Certus 16 Pin IO Breakout Cable Connector Pin-out

7 Installing Certus

To install and quickly get started with Certus, follow the instructions provided in [7.1 Installation Checklist](#).

More Information...

See	For
7.2 Mounting Certus	Guidelines for selecting the mounting location for the unit and setting the alignment with respect to the vehicle and antennas.
7.3 Power Supply	Recommendations for setting up power supply.
7.4 Electrical Domains	Information on how to minimise interference due to noise.
7.5 GNSS Antennas	Guidelines on how to install GNSS antennas and route cables.
7.6 Net-working	Information about changing Certus to a fixed IP address system after establishing a connection.
7.7 Odometer	Different options using an odometer to improve the navigation and orientation.
7.8 Mag-netics	Information on the effects of magnetic interference.
7.9 Vibration	Steps to mitigate the adverse effects of vibration on the performance.

Table 26: Additional Information

Note: For ordering an evaluation kit, a standalone kit or accessories for Certus, see [5 Part Numbers and Ordering Options](#).

7.1 Installation Checklist

The following checklist provides the basic steps for connecting, mounting and configuring a Certus unit.

1. Plug the power supply into the power connector on the breakout cable and then into the wall socket. See [7.3 Power Supply](#).
2. Connect to Certus using one of the following methods:
 - a. **Ethernet**
 - i. Plug the 8 pin breakout cable into the IO1 connector on the Certus.
 - ii. Plug an Ethernet cable into the Ethernet socket on the breakout cable, and into your network.
 - iii. Download and install the Bonjour ZeroConf networking utility from the link <https://www.advancednavigation.com/Bonjour64.msi>.
 - iv. In a web browser, type in the address <http://certus.local>.
 - b. **RS232 Serial**
 - i. Plug the 16 pin breakout cable into Certus.
 - ii. Connect the USB to RS232 / RS422 adaptor cable to the Primary port and your computer. The Certus factory default setting is RS232. Check that the mode switch is at the correct

setting.

- iii. **Java 11 is required** to run Certus Manager.
Adoptium JRE 11 is the recommended Java installer to be used on all platforms. Install the latest version of Java 11 from [Adoptium](#), selecting the correct operating system and architecture for your computer.
- iv. Download Certus Manager from the [Certus](#) product page of the Advanced Navigation website.

Note: Certus Manager is only available for systems with x64 architecture

- v. Double click Certus Manager to start the application. See [9.2 Using Certus Manager](#) for specific notes for different platforms
 - vi. Select the correct COM port.
 - vii. Select the Baud Rate. The default baud rate is 115200 bps.
 - viii. Click **Connect**.
3. Mount the unit in the standard alignment of X+ pointing forward and Z+ pointing down. For more information, see [Mounting Alignment](#).
 4. Mount the two GNSS antennas in a level orientation with a clear view of the sky. The primary antenna should be positioned directly forwards of the secondary antenna with separation of at least 0.5 metres. See [7.5 GNSS Antennas](#).
 5. Connect the coaxial antenna cables between the antennas and Certus. The antenna cables should not be coiled.
 6. Accurately measure the GNSS antenna offset from the centre of the Certus unit to the central base of the primary antenna in the body co-ordinate frame (X+ forward and Z+ down, see [12.3 The Body Co-ordinate Frame](#)) and enter these values into the [9.1.3.4 Alignment](#) screen under the **Configuration** menu. See [7.5 GNSS Antennas](#) for more details.
 7. Choose a Vehicle Profile in the [9.1.3.2 Filter Options](#) screen under the **Configuration** menu. This should be the closest available match to your vehicle type. If you need more information, contact Support at support@advancednavigation.com.
 8. Check that all filters are initialised. See [8.1 Filter Initialisation](#).
The system is now ready for use.

7.2 Mounting Certus

When installing Certus into a vehicle, the mounting position and alignment of the unit are essential for achieving optimal performance. Position refers to the physical location within the vehicle where the unit is installed while alignment refers to the orientation of the unit with respect to the orientation of the vehicle.

Before you install Certus, review the considerations for selecting a location and instructions alignment of the unit outlined below.

When planning a mounting location for Certus, be mindful of the following recommendations:

- Mount the unit in an area that will not exceed the rated temperature range, and with minimal temperature swings.
- Mount the unit away from high levels of vibration where possible.
- Mount the unit within several metres of the GNSS antennas where possible.
- Mount close to the centre of gravity of the vehicle where possible.

- Mount the unit at least 10 cm away (and preferably as far as possible) from sources of dynamic magnetic interference such as high current wiring or large motors for best performance.
- Do not obstruct the two vents on the side of the enclosure unless [8.9 Atmospheric Altitude](#) will be disabled.

The Certus mounting plate and hole guide are shown in [7.2.1 Mounting Plate Layout](#). The holes are designed for M3 screws.

For instructions on alignment of the unit within a vehicle, see [Mounting Alignment](#).

7.2.1 Mounting Plate Layout

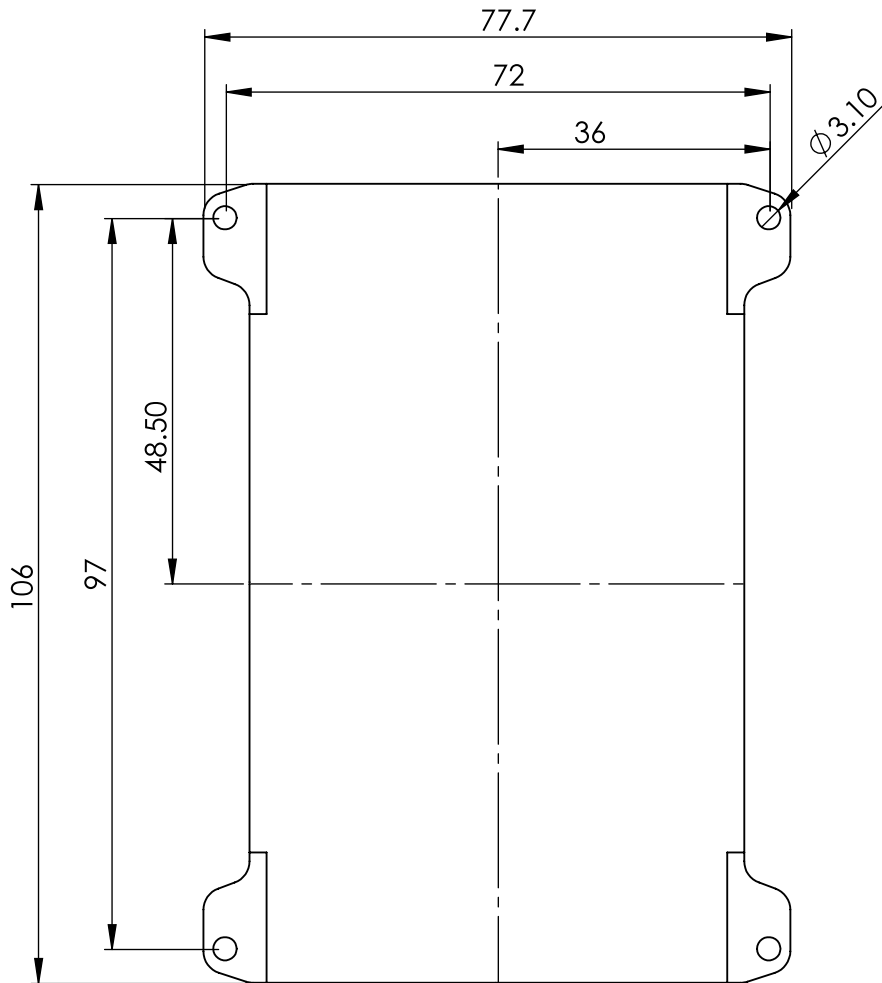

Figure 16: Bottom View of Certus Mounting Plate

7.3 Power Supply

A high level of power supply filtering has been built into Certus to allow for reliable operation in demanding environments. However, a power supply with low noise and ripple levels, and adequate transient response is still recommended. Certus contains a fully isolated power supply and has separate grounds for power and signals to ensure that power supply noise does not corrupt communications or cause ground loops with other equipment. See [7.4 Electrical Domains](#) for more details about isolation.

The power supply must be able to reliably provide the maximum current at the chosen voltage, especially in systems with substantial load variations. Make sure that all system components are rated (including safety factors) for the anticipated environmental operating conditions and stressors of the system. Refer to section [6.3 Hardware Specifications](#) for further information.

Certus contains an active protection circuit on the power supply input that protects the unit from under-voltage, over-voltage and reverse polarity events. It is recommended to always operate the unit at a voltage higher than the minimum mentioned in the Certus [6.5 Electrical Specifications](#). Take caution when using a supply voltage close to the minimum voltage as minor voltage fluctuations could trigger under-voltage protection, leading to unexpected oscillations between the on and off states.

Note: Both connectors have a power supply connection. Only one of these power supplies should be connected. Connecting two different power supplies could result in damage to the unit.

7.4 Electrical Domains

Certus contains separate electrically isolated domains. Each domain is isolated from the others to minimise noise injection and avoid ground loops. Where possible, this isolation should be preserved by externally connected devices. We recommend connecting the enclosure to your vehicle ground where possible for the best electrical noise performance.

Domain Name	Affected Components and Ports
Chassis	Enclosure, GNSS receiver, GNSS antennas
Power	Power Supply
Serial	Primary port, Auxiliary port, CAN port
GPIO	GPIO 1 port, GPIO 2 port, 1PPS port
Ethernet	Ethernet port

Table 27: Certus Electrical Domains

7.5 GNSS Antennas

The GNSS antennas should be installed level with respect to each other, with a clear unobstructed view of the sky, away from reflective surfaces and with the shortest cable run to the Certus unit permitted by the application. The antennas should be mounted away from any RF emitters such as radars, high-powered communication links, etc. It is important to have a ground plane (flat conductive surface such as a piece of plate aluminium) under the antenna with a minimum radius of 60mm or as recommended by the antenna supplier. Correct antenna positioning is critical for Certus's dual-antenna heading function.

The primary GNSS antenna position offset should be configured in the Certus unit by using the Alignment page in the web UI or Certus Manager. See [9.1 Using the Web User Interface](#) or [9.2 Using Certus Manager](#). The antenna offset is measured from the physical centre of the Certus unit to the central base (ARP) of the primary GNSS antenna in the body co-ordinate frame (X+ forward, Z+ down).

Note: The Z axis is positive downwards, mounting the antenna above the Certus unit will require a negative Z offset. It is very important to set this antenna offset accurately as Certus corrects for lever arm velocities. An incorrect GNSS antenna offset will lead to performance degradation under turning and angular rotations.

An example installation with the body co-ordinate frame axes marked is shown below in Certus antenna offset isometric view and Certus antenna offset front view. In this installation below with an antenna mounted on the right-hand side of the vehicle roof, further forward from the Certus unit, there would be a positive X antenna offset value, a positive Y antenna offset value and a negative Z offset value.

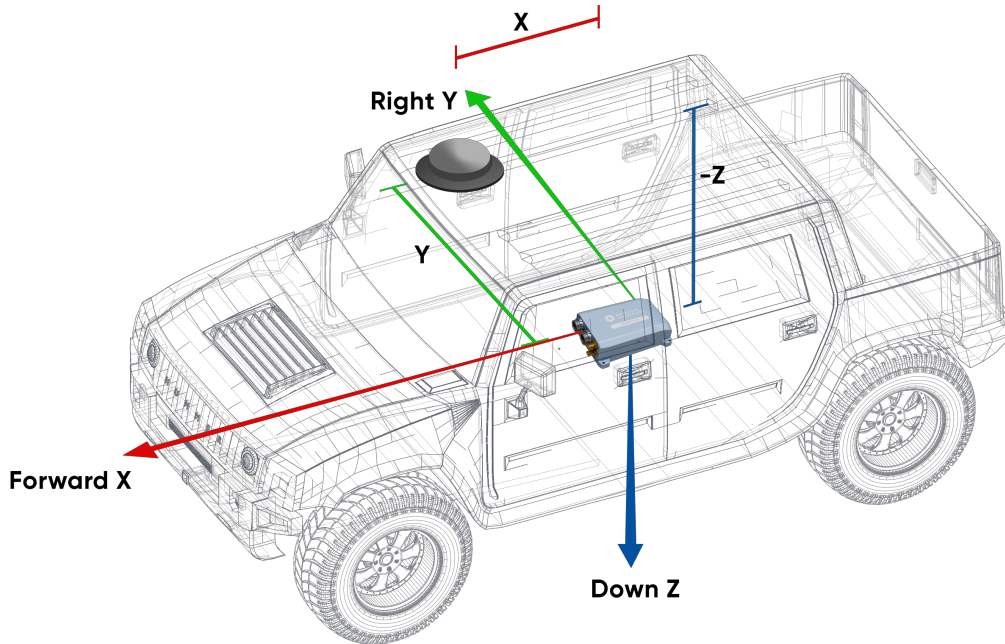

Figure 17: Antenna Offset Isometric View

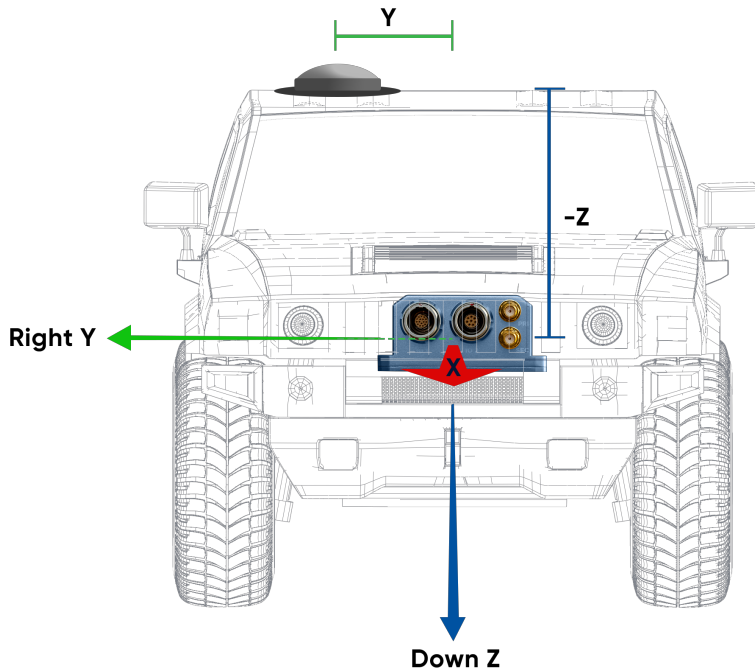

Figure 18: Antenna Offset Front View

The secondary antenna should be mounted behind the primary antenna with as much separation as possible, and in line with the long axis of the vehicle, in the direction of travel, with as much separation as practically possible. The heading accuracy can be improved by increasing the antenna separation. See [6.1 Navigation Specifications](#) specifications.

If it is impractical to mount the secondary antenna directly behind the primary antenna due to physical constraints, it can be mounted in another position. In this case the secondary antenna configuration must be entered into the Dual Antenna page in the web UI or Certus Manager. See [9.1 Using the Web User Interface](#) or [9.2 Using Certus Manager](#).

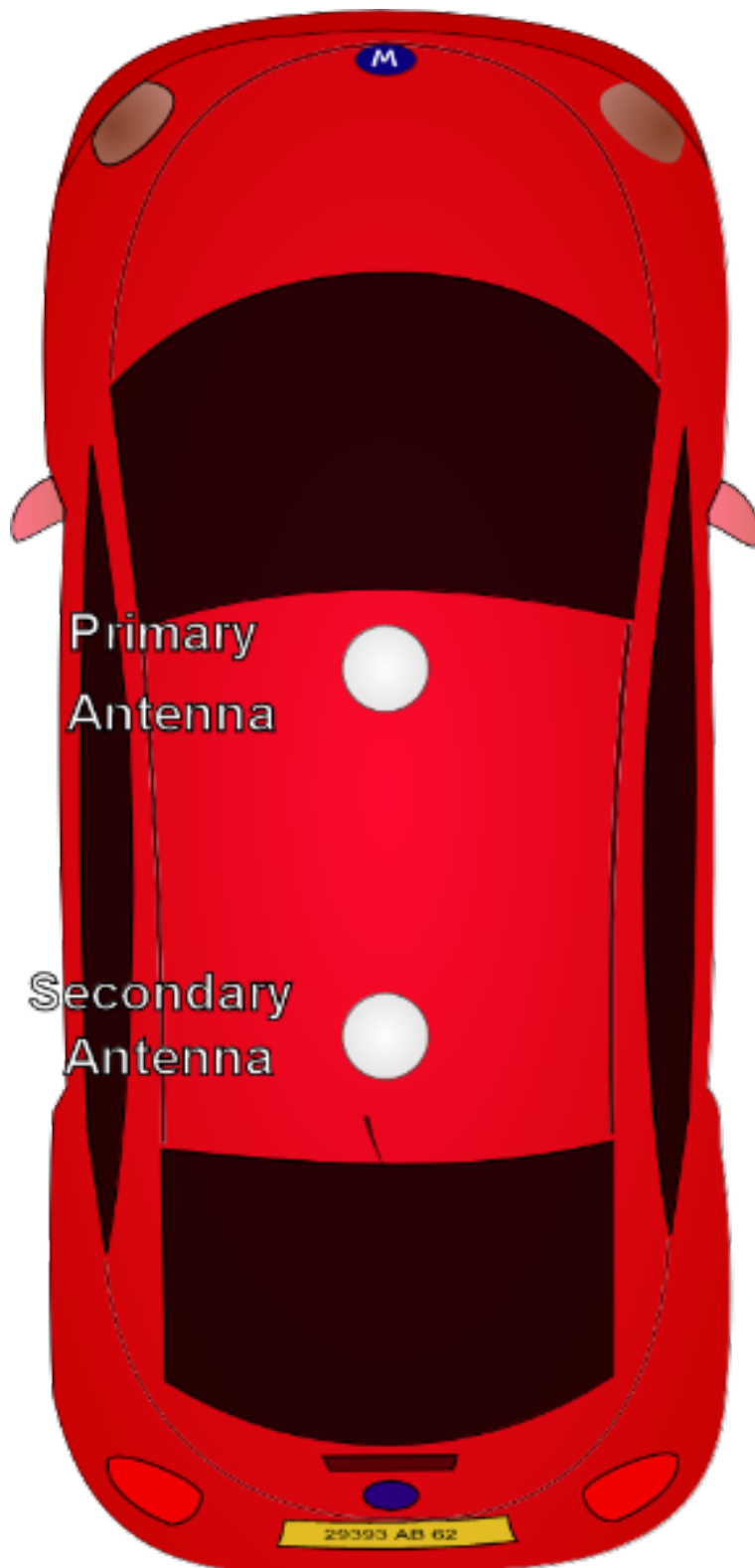

Figure 19: Recommended Second Antenna Placement

The standard antennas supplied in the Certus Evaluation Kit are the Antcom G5ANT-53A4T1. They are an L1/L2/L5 RTK antenna that support GPS, GLONASS, BeiDou, Galileo, and SBAS. They are environmentally sealed to the IP68 standard.

If you are sourcing your own antennas, note the following antenna guidelines:

- The antenna should be capable of receiving both L1 and L2. Heading performance will be significantly degraded with an L1-only antenna.
- Active antennas should have sufficient LNA gain, which when accounting for cable losses, provides at least 33 dB of gain at the connector of the unit.
- The antenna needs to have an accurate phase centre to be RTK capable. This is also required for the dual antenna heading to function correctly. Low performance (low cost) antennas are typically not able to achieve good heading performance.
- The antenna should support GPS, GLONASS, BeiDou, and Galileo.
- The antenna should be environmentally sealed, including connectors.

7.5.1 Antenna Cables

The antenna cables should be routed away from powerful RF emitters, high current wiring, high temperatures and any rotating or reciprocating machinery. It is very important not to bend the antenna cable tighter than its minimum bend radius, or to allow it to be dented. It is recommended to use wide cable ties, loosely fixed in order to avoid damaging the insulation or shielding. The cables should not be coiled. Advanced Navigation recommends:

- Keeping the antenna cables the same length, and as short as possible.
- Using either RG58 low loss or LMR240 coaxial cable combined with high quality connectors. LMR300 and LMR400 can also be used to minimise loss for very long antenna cables.

Cable Type	Minimum Bend Radius	Signal Loss
RG-58/U Low Loss	20 mm	~0.92 dB/m
LMR240	20 mm	~0.33 dB/m
LMR300	22.2 mm	~0.26 dB/m
LMR400	25.4 mm	~0.17 dB/m

Table 28: GNSS antenna co-axial cable properties

The Certus end of the antenna cables must have standard male SMA connectors.

If you are sourcing your own antenna cables it is important to ensure that the antenna has enough gain to support the signal loss over the cable. Certus requires a minimum of 33 dB of gain at the connector. With the standard 4 metre RG-58A/U antenna cables supplied by Advanced Navigation, the minimum antenna gain required is 36.5 dB.

7.5.2 Antenna Suction Cup Mount

A suction cup mount can be used when antennas need to be mounted at any angle or on a smooth, non-porous surface such as a window or on vehicles with aluminium or fibreglass bodies. A suction cup mount can be attached and removed quickly and can easily be moved from one location to another. See [5.5 Accessories](#).

7.5.3 Antcom Antenna Survey Mount Assembly

If using the optional Antcom G5ANT-53A4T1 antenna, mount it to a panel or mount to a standard 5/8"-11 survey mount with the included survey mount kit. See the figure below for assembly of each antenna with the survey mount kit.

Note: The ground planes are not optional.

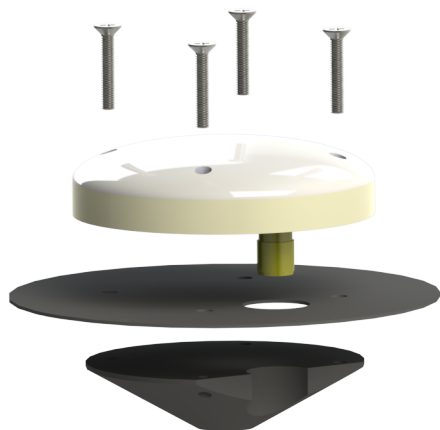

Figure 20: Antenna Survey Mount

7.6 Networking

The default configuration for Certus is for the DHCP Client to be Enabled. This makes it a plug-and-play solution for most users. It is possible to change Certus to a fixed IP address system once a connection has been established.

Certus supports the Zero Configuration (Zeroconf) networking feature. On Linux and MacOS systems no additional software is required. If you are using Microsoft Windows, install the Apple Bonjour software from <https://www.advancednavigation.com/Bonjour64.msi> if it's not already installed. Open a web browser and type in the address <http://certus.local/> to discover the device and access the web interface.

If you cannot establish a connection using a DHCP-capable network, you can connect to and configure the Certus using the Primary port RS232 serial interface and the Certus Manager application.

Note: A factory reset will re-enable the DHCP Client and lose any static IP address settings.

7.7 Odometer

On ground vehicles, the use of an odometer input will greatly improve the Certus navigation and orientation solution during GNSS outages.

There are several different options for odometer that are explained as follows.

7.7.1 Factory VSS Signal

Most mass-market vehicles since 1980 contain a VSS (vehicle speed sensor) signal that can be wired directly into one of the Certus GPIO pins. Any voltage limits on this pin that must be taken into consideration.

To set up the odometer, the appropriate GPIO pin should be set to Odometer Input using Certus Manager. The odometer pulse length must then be set either manually or automatically, see [8.10 Odometer Pulse Length](#) for more information.

For more information on the GPIO signals and their requirements see [10.6 GPIO Pins and the Auxiliary Port](#).

7.7.2 OBDII Odometer Interface

For applications where it is undesirable to modify the vehicle or the system needs to be used with multiple vehicles, the OBDII odometer interface may be a better solution. OBDII is a vehicle diagnostic port standard and most vehicles from the mid 1990s onwards contain an OBDII port in the drivers side foot well. Advanced Navigation produces an inexpensive OBDII Odometer Interface that plugs into this OBDII port and feeds Certus with odometer data over the Auxiliary RS232 port. See the figure below. Contact the Advanced Navigation sales team at sales@advancednavigation.com for more information.



Figure 21: Advanced Navigation OBDII Odometer

7.7.3 Aftermarket Wheel Speed Sensor

Applications requiring very high performance without GNSS for any length of time are recommended to use a high precision aftermarket wheel speed sensor. Advanced Navigation recommends aftermarket wheel speed sensors from Kistler, Pegasem or GMH Engineering.



Figure 22: Aftermarket Wheel Speed Sensor

7.7.4 Radar Speed Sensor

For applications requiring high performance in harsh conditions where aftermarket wheel speed sensors are not feasible, a radar speed sensor is recommended. Advanced Navigation recommends radar speed sensors from Stalker or GMH Engineering.



Figure 23: Radar Speed Sensor

7.8 Magnetics

Certus contains magnetometers which it can use to measure the Earth's magnetic field in order to determine its heading. The principle is the same as that of a compass. When operating Certus with magnetic heading enabled, sources of magnetic interference can degrade the Certus solution if not compensated for.

Note: Magnetic interference affects the performance of gyroscopes by causing rotation errors; it is recommended that you mount Certus away from magnetic interference.

There are two types of magnetic interference: **Static** and **Dynamic**.

Sources of static magnetic interference are predominantly ferrous materials (e.g. steel, iron, nickel, cobalt), high-current cables and permanent magnets located near the Certus. Static disturbances are easily compensated for by running a magnetic calibration. A magnetic calibration should always be performed after installation into a vehicle if accurate magnetometer heading is required. See [8.5 Magnetic Calibration](#) for instructions on how to calibrate your device.

Dynamic magnetic interference is a much more complex and problematic issue due to its many variable factors and unpredictability. Sources of dynamic magnetic interference include high current wiring, electric motors, servos, solenoids and nearby large masses of metal that don't move with Certus. Certus should be mounted as far as possible from these interference sources.

Certus contains a special algorithm to reduce the effects of dynamic magnetic interference. This is able to compensate for most typical interference sources encountered, however certain types of prolonged dynamic interference cannot be compensated for. The best way to check for dynamic magnetic interference is to use the Raw Sensors view in the web UI or Certus Manager and watch the magnetometer outputs whilst the vehicle is operating but stationary. See [9.1 Using the Web User Interface](#) or [9.2 Using Certus Manager](#). The values should be constant: if the values are fluctuating there is dynamic magnetic interference present.

If dynamic magnetic interference is causing performance problems and there is no way to mount Certus away or, where practical, magnetically shield it from these interference sources, the magnetometers should be disabled and an alternative heading source should be used, see [8.5.4 Disabling Magnetometers](#).

7.9 Vibration

Certus is able to tolerate a high level of vibration compared to other inertial systems. This is due to a unique gyroscope design and a special filtering algorithm among other things. There is, however, a limit to the amount of vibration that a unit can tolerate — temporary degradation in accuracy may occur while operating under high vibration.

When mounting Certus to a platform with vibration present, there are several options to mitigate the negative performance effects. It is recommended to conduct a brief operating check to confirm performance is within specification before conducting longer runs. The Raw Sensor view in the web UI or Certus Manager can give you a good idea of how bad the vibrations are. If the vibrations or shocks in operation are causing the sensors to go over range, you will need to increase the sensor range because this will significantly degrade position and orientation estimates. See [8.6 Sensor Ranges](#) for details.

If there are persistent issues:

- Try to find a mounting point with less vibration.
- Certus can be mounted with a small flat piece of rubber to provide some isolation. This must not be very soft foam which may result in an incorrect level over time.
- Mount Certus to a plate which is then mounted to the platform through vibration isolation mounts. Be mindful that a plate with very soft mounts may also cause problems with shifts in orientation over time.

8 Using Certus

This section covers the following topics:

- [8.1 Filter Initialisation](#)
- [8.2 Hot Start](#)
- [8.3 Time](#)
- [8.4 Heading Sources](#)
- [8.5 Magnetic Calibration](#)
- [8.6 Sensor Ranges](#)
- [8.7 Data Anti-aliasing](#)
- [8.8 Vehicle Profiles](#)
- [8.9 Atmospheric Altitude](#)
- [8.10 Odometer Pulse Length](#)
- [8.11 Reversing Detection](#)
- [8.12 Motion Analysis](#)
- [8.13 RTK](#)
- [8.14 Raw Satellite Data](#)
- [8.15 Kinematica Post Processing](#)
- [8.16 Vents](#)
- [8.17 RAIM](#)
- [8.18 Heave](#)
- [8.19 Environmental Exposure](#)
- [8.20 Upgrading the Certus Firmware](#)

8.1 Filter Initialisation

There are four different levels of filter initialisation on Certus. These are orientation, navigation, heading and time.

The initialisation of each can be monitored by inspecting the [9.1.2.4 Status](#) view in the web UI or [9.2.6 View Menu](#) in the Certus Manager.

Initialisation

- Orientation
- Navigation
- Heading
- Time

Figure 24: Initialisation Levels

After all four levels of initialisation, the Certus INS filter takes several minutes to achieve its full accuracy. It is recommended to wait two minutes after initialisation for applications requiring high accuracy.

8.1.1 Orientation Initialisation

Orientation initialisation occurs automatically upon power on and typically completes within seconds. To determine its orientation it uses the accelerometers to measure the gravity vector. Random accelerations from environmental sources can disturb this process, which can introduce minor orientation errors that will be corrected within several seconds. To prevent this, Certus monitors the accelerometers and gyroscopes and restarts the orientation detection if there are sudden movements. It is however still possible under some circumstances for it to miss minor movements and start with a small orientation error. Certus will progressively correct the orientation error over a period of several seconds.

Once orientation initialisation is complete, the roll, pitch and angular velocity values will be valid.

8.1.2 Navigation Initialisation

Navigation initialisation completes once the system has determined a starting absolute position. The most common method of navigation initialisation is for the system to get a 3D GNSS fix or better. If the system is hot-starting it will remember its position at the time it was switched off and use this as the starting position. The other possibility for navigation initialisation is an external position source to be used, see [11.4.25 External Position Packet](#) for more information. In a situation where a GNSS fix is not available to initialise navigation, it can be initialised manually by entering a position into the [9.1.3.10 Manual Initialisation](#) page in the web UI or the [9.2.7.12 Manual Initialisation](#) dialogue in the Certus Manager.

Once navigation initialisation is complete, the position, velocity and acceleration values will be valid.

8.1.3 Heading Initialisation

Heading initialisation completes once the system has determined a heading using one of its several methods. The conditions required to determine a heading depend upon the heading source being used, see [8.4 Heading Sources](#). The default heading source is dual antenna, which will initialise the heading to a high accuracy within

several minutes of power on assuming that both antennas are connected with an unobstructed view of the sky. The system can be stationary or moving during this initialisation. If velocity heading is enabled and the vehicle is moving, this will be very fast. If the system hot-starts, the last known heading value will be used. However, in order for the Heading Filter to initialise, the system must have a valid heading source.

Until the heading has been initialised, the system will not be able to navigate without a GNSS fix, and the roll and pitch values will not reach full accuracy.

8.1.4 Time Initialisation

Time initialisation completes once the system has determined time accurately. This occurs as soon as the GNSS receiver obtains its first fix. For this to occur the system must receive rough time as well as a 1PPS signal on one of the GPIO pins. It is also possible to acquire time from an external source, see [11.4.32 External Time Packet](#) for more information.

Until the time has initialised, the Unix or formatted time that Certus outputs will be flagged as invalid.

8.2 Hot Start

Advanced Navigation devices were the first on the market with hot-start functionality. This hot-start functionality allows Certus to start inertial navigation within 500 ms to 2s, and obtain a GNSS fix in as little as 2 seconds. The hot-start functionality is always on and fully automatic. See [6.1 Navigation Specifications](#) for details.

A next generation backup battery system within Certus provides the hot-start ability for more than 48 hours without power. When Certus hot-starts, it assumes that it is in the same state it was when it lost power and begins navigating from that position. The hot-start also provides ephemeris, almanac and time information to the GNSS receiver which allows it to achieve a GNSS fix far more quickly than it otherwise could. When the GNSS achieves its first fix, Certus will jump to the new position without disturbing the filter.

Whenever Certus is without power it continues to accurately keep time so that it is immediately valid for a hot-start.

The hot-start functionality is of particular benefit to vehicle tracking and robotics applications. The primary benefits are immunity and fast recovery from power failure as well as fast start up time.

8.3 Time

Certus has been designed to provide a highly accurate time reference. It contains a temperature compensated disciplined oscillator that corrects itself very precisely using GNSS time. When a GNSS fix is available, the Certus time is accurate to within 20 nanoseconds.

When the GNSS fix is lost, the Certus time will slowly lose accuracy at a rate of approximately 3 microseconds per hour.

When Certus hot-starts the time accuracy is typically within 1-2 seconds immediately on startup and corrected to within 50 nanoseconds as soon as a GNSS fix is achieved.

The time can be accessed via the following means:

- A dedicated [10.3 1PPS Signal](#). This is the preferred means to obtaining the most accurate timing output.
- A 1PPS output over GPIO or the Auxiliary port, see [10.6.1.2 1PPS Output](#) of the Dynamic Pin Functions.
- A built-in Precision Time Protocol (PTP) version 2 server for synchronisation with network-connected devices which require high accuracy time. The PTP server broadcasts PTP messages (Sync, Follow Up, Announce) to multicast IP address 224.0.1.129. The PTP broadcasts are sent whenever an Ethernet

connection is established and cannot be disabled.

- A built-in Network Time Protocol (NTP) server.

8.4 Heading Sources

There are several different heading sources available for Certus. The heading sources can be configured using the **Filter Options** page in the Web UI (see [9.1 Using the Web User Interface](#)) or in the Manager application (see [9.2 Using Certus Manager](#)). It is possible to use multiple heading sources and this can provide performance benefits.

8.4.1 Dual Antenna Heading

This is the default heading source and provides the most accurate heading while GNSS is available. Dual antenna heading only works when a good GNSS fix is available to both antennas. It requires a clear view of the sky with minimal nearby sources of interference or multipath. The greater the antenna separation, the higher the accuracy (see [6.1 Navigation Specifications](#)). A minimum antenna separation of 0.5 metres is required.

Certus will operate with a single primary antenna connected, but this will prevent dual-antenna heading being used, although velocity heading will still be possible.

8.4.2 Velocity Heading

Velocity heading works by deriving heading from the direction of velocity and acceleration. Velocity heading works well with cars, fixed wing aircraft and other vehicles that don't move sideways. Velocity heading cannot work for helicopters and other vehicles where the vehicle is pointed somewhere other than the direction of travel. Velocity heading requires a horizontal speed of over 1.15 m/s with a GNSS fix. Velocity heading is disabled by default.

8.4.3 Magnetic Heading

This is the default heading source and works well in the majority of cases. When using magnetic heading, magnetic calibration is required every time the static magnetic field around the Certus changes. This can occur, for example, when moving the mounting location of the unit, or making significant structural changes to the vehicle that alter the distribution of ferrous materials. The downside of magnetic heading is that prolonged exposure to dynamic magnetic interference can cause significant heading errors. See [7.8 Magnetics](#) and [8.5 Magnetic Calibration](#) for further information. Magnetic heading is enabled by default.

8.4.4 External Heading

This can be used if there is some other way to derive heading that is external to Certus. The heading must be supplied to Certus using the [11.4.28 External Heading Packet](#) or an NMEA message, see [10.6.1.29 NMEA Input](#).

8.4.5 External Magnetometers Packet

Heading can be derived using the magnetometers of an additional external Advanced Navigation product to input external magnetometer values. See [11.4.46 External Magnetometers Packet](#) for details.

8.5 Magnetic Calibration

Static magnetic interference is resolved through magnetic calibration. Dynamic magnetic interference is compensated by a filter algorithm, but should be minimised where possible by selecting the best possible mounting location or implementing magnetic shielding — see [7.8 Magnetics](#) for more information. To compensate for static magnetic interference, magnetic calibration should be performed whenever the Certus mounting location or operation environment changes.

Certus contains a dynamic magnetic compensation filter that is able to mitigate the effects of short term magnetic interference sources while in operation. For example, if Certus is installed in a car and the car drives over a large piece of magnetised steel, this will be compensated for. Another example is driving through a tunnel which is built from reinforced concrete, which can distort the local magnetic field substantially. It is important to note that for the Certus dynamic magnetic compensation filter to operate correctly, Certus needs to get a GNSS fix at least once every time it is moved more than 50 km. Each time Certus moves more than 50 km the new position is stored permanently and allows Certus to update its world magnetic model values.

There are three types of magnetic calibration available: 2D calibration, 3D calibration and automatic calibration. The three magnetic calibration types and their respective typical applications are described as follows.

- 2D calibration involves at least one full rotation of the vehicle about the Z-axis and is designed for vehicles that are not intended to travel whilst turned upside down, such as full-sized cars, passenger planes and boats.
- 3D calibration involves at least two full rotations of each axis (X, Y and Z) and is designed for vehicles that are intended to be manoeuvred and travel upside down, such as underwater vehicles. 3D calibration offers slightly better performance, and is recommended where possible. Be mindful that the support mechanism used to support the vehicle during calibration can influence the results.
- Automatic magnetic calibration continuously and automatically calibrates for static magnetic interference while the unit is in operation. While it is not as accurate as 2D or 3D calibration, and can take significantly longer to calibrate, automatic magnetic calibration is very convenient for applications where it is impractical to employ those methods.

Note: If Certus is going to be used in a vehicle, the calibration should be performed while Certus is mounted in and fixed to that vehicle. This means that the whole vehicle must be moved to perform the calibration. The calibration needs to be performed in an area away from other sources of magnetic interference. For example if Certus is installed in a car, the calibration should not involve driving over steel drains or reinforced concrete etc. If Certus is being calibrated to operate standalone, the calibration should not be done on a desk with a steel frame.

8.5.1 2D Magnetic Calibration

The following procedure should be used to perform a 2D magnetic calibration.

8.5.1.1 2D Magnetic Calibration Using the Web UI or Certus Manager Software

1. The unit should be powered on while the vehicle is in a level orientation and kept stationary. It is recommended this be done in an outdoor area away from metal or obstructions.
2. After power on wait 5 minutes for the temperature and filter to stabilise.
3. Open the web UI or Certus Manager and connect to the device.
4. In the **Tools** menu, open **Magnetic Calibration**. Click the **2D Calibration** button.

5. Whilst keeping as level as possible, rotate the vehicle in either direction through one and a quarter full rotations. In a car or boat this can be achieved by driving in one and a quarter circles.
6. Check the status in the **Magnetic Calibration** window to ensure that the calibration completed successfully. If not successful, click **Cancel**, wait 2 minutes and repeat from step 4.

Note: Do **not** press the Save button in the lower half of the page, this will overwrite the new calibration values. The auto-generated calibration values are automatically saved internally by Certus.

8.5.1.2 2D Magnetic Calibration Using the Packet Protocol

1. The unit should be powered on while the vehicle is in a level orientation and kept stationary.
2. After power on wait 5 minutes for the temperature and filter to stabilise.
3. Ensure that the device has a position fix, either from an external GNSS receiver, or using the External Position and Velocity packet #44 or the External Position packet #45, before proceeding.
4. Send the [11.5.9 Magnetic Calibration Configuration Packet](#) with the action **Start 2D Magnetic Calibration**.
5. Whilst keeping as level as possible, rotate the vehicle in either direction through one and a quarter full rotations. In a car this can be achieved by driving in one and a quarter circles.
6. Read the [11.5.10 Magnetic Calibration Status Packet](#) to ensure that the calibration completed successfully. If not successful, send the [11.5.9 Magnetic Calibration Configuration Packet](#) with the action **Cancel**, wait 2 minutes and repeat from step 4.

8.5.2 3D Magnetic Calibration

The following procedure should be used to perform a 3D magnetic calibration.

8.5.2.1 3D Magnetic Calibration Using the Web UI or Certus Manager Software

1. The unit should be powered on and the vehicle kept stationary. It is recommended this be done in an outdoor area away from metal or obstructions.
2. After power on wait 5 minutes for the temperature and filter to stabilise.
3. Open the web UI or Certus Manager and connect to the device. Ensure that the device has a GNSS fix before proceeding.
4. In the **Tools** menu, open **Magnetic Calibration**. Click the **3D Calibration** button. The following steps 5, 6 and 7 can be performed in any order.
5. Slowly rotate the vehicle twice around the X-axis (roll).
6. Slowly rotate the vehicle twice around the Y-axis (pitch).
7. Slowly rotate the vehicle twice around the Z-axis (heading).
8. Check the status in the **Magnetic Calibration** window to ensure that the calibration completed successfully. If not successful click **Cancel**, wait 2 minutes and repeat from step 4. Do **not** press the save button in the lower half of the page, this will over write the new calibration values. The auto-generated calibration values are automatically saved internally by Certus.

8.5.2.2 3D Magnetic Calibration Using the Packet Protocol

1. The unit should be powered on and the vehicle kept stationary.
2. After power on wait 5 minutes for the temperature and filter to stabilise.
3. Ensure that the device has a position fix, either from an external GNSS receiver, or using the External Position and Velocity packet #44 or the External Position packet #45, before proceeding.
4. Send the [11.5.9 Magnetic Calibration Configuration Packet](#) with the action **Start 3D Magnetic Calibration**. The following steps 5, 6 and 7 can be performed in any order.
5. Slowly rotate the vehicle twice around the X-axis (roll).
6. Slowly rotate the vehicle twice around the Y-axis (pitch).
7. Slowly rotate the vehicle twice around the Z-axis (heading)
8. Read the [11.5.10 Magnetic Calibration Status Packet](#) to ensure that the calibration completed successfully. If not successful, send the [11.5.9 Magnetic Calibration Configuration Packet](#) with the action **Cancel**, wait 2 minutes and repeat from step 4.

8.5.3 Automatic Magnetic Calibration

Automatic magnetic calibration is an algorithm that continuously and automatically calibrates for static magnetic interference. Automatic magnetic calibration is enabled by default and it is recommended to keep it enabled for all vehicle types. When used on top of a 2D or 3D calibration it can give the best results from magnetic heading.

The automatic calibration for 2D vehicles differs from that for 3D vehicles. To ensure the correct calibration is being applied, ensure the correct vehicle profile is selected for your application in the [9.1.3.2 Filter Options](#) page in the web UI or the [9.2.7.3 Filter Options](#) dialogue in the Certus Manager.

8.5.3.1 2D Vehicle Profiles

2D vehicles are those which cannot easily or safely be turned upside down, and typically include vehicles such as cars and bicycles.

Each time Certus is powered on in a cold start (48 hours without power) the automatic calibration is reset. The automatic magnetic calibration starts operating when Certus is travelling at a speed over 5 m/s with a GNSS fix and either dual antenna is the heading source or velocity heading is turned on.

Automatic magnetic calibration is not as accurate as 2D or 3D calibration, however, it is sufficient for most vehicles and allows Certus to be installed into vehicles and operated without user intervention.

Automatic magnetic calibration can be turned off using the [9.1.3.2 Filter Options](#) page in the web UI or the [9.2.7.3 Filter Options](#) dialogue in the Certus Manager.

8.5.3.2 3D Vehicle Profiles

3D vehicles are those which can easily or safely be turned upside down, and typically include vehicles such as humans, underwater vehicles and fixed wing planes.

Each time Certus is powered on in a cold start (48 hours without power) the automatic calibration is reset, and a new calibration will begin if a significant change in calibration values is detected. The automatic calibration for 3D vehicle profiles requires no prior calibration or minimum velocity to begin.

The calibration time is dependent upon the rotation about each axis; approximately, 1 degree of uniform motion in each axis will take up to an hour to converge, motion as low as 0.2-0.5 degrees will take upwards of 12 hours to converge, and 10 degrees of motion will take around 40 seconds to converge. These time estimates are dependent on the environment and nature of the motion.

Automatic magnetic calibration can be turned off using the [9.1.3.2 Filter Options](#) page in the web UI or the [9.2.7.3 Filter Options](#) dialogue in the Certus Manager.

8.5.4 Disabling Magnetometers

In situations where there are very strong dynamic magnetic disturbances present, it is recommended to disable the magnetometers. When the magnetometers are disabled, an alternative heading source is required or else Certus may become inaccurate. Dual antenna heading is the recommended source. See [8.4 Heading Sources](#) for information. The magnetometers can be disabled using the Magnetic Heading setting on Filter Options page in the web UI or Certus Manager. See [9.1 Using the Web User Interface](#) or [9.2 Using Certus Manager](#).

8.6 Sensor Ranges

Note: Certus Evo does not support configurable sensor ranges, the following functionality only applies to Certus

Certus supports dynamic ranging on its sensors. Each of the three sensors have three different range settings. At lower ranges the sensor performance is better, but at higher ranges Certus can be used in more extreme dynamics. The best performance is achieved by choosing the lowest range that your application won't generate over-range events.

Sensor over-range events can be detected in the [Filter Status field](#). In the web UI and Certus Manager the status indicator will go orange to indicate that a sensor has gone over-range. When a sensor goes over-range this causes the filter to become inaccurate, and in some cases it can cause the filter to reset.

By default Certus comes configured to the lowest (most sensitive) sensor ranges. In this configuration it is possible to send the gyroscopes over-range by quickly rotating the unit in your hand. It is recommended to monitor the web UI or Certus Manager when you do this.

The sensor range can be set using the [9.1.3.1 Sensor Ranges](#) page in the web UI or using the [9.2 Using Certus Manager](#).

8.7 Data Anti-aliasing

Internally the Certus filters update at 1,000 Hz. When Certus outputs data, most applications require the data at a much lower rate (typically less than 100 Hz). This causes a problem for time-based data such as velocities and accelerations where aliasing will occur at the lower rate. To prevent this problem, if the output rate is lower than 1000 Hz, Certus will low-pass filter the values of the time dependent data between packets to prevent aliasing. This is only the case when a packet is set up to output at a certain rate. If the packet is simply requested, no anti-aliasing will occur. Additionally there is no anti-aliasing for non time-dependent fields such as position.

8.8 Vehicle Profiles

Certus supports a number of different pre-configured vehicle profiles. These vehicle profiles impose constraints upon the filter to increase performance. If your application matches one of the available vehicle profiles, it is required that you select it for use in the [Filter Options](#) page in the Web UI or Certus Manager. For a list of the different vehicle profiles, see [11.5.6.1 Vehicle Types](#). If the wrong vehicle profile is selected, it can cause a significant decrease in performance. It is recommended to Reset the unit after changing vehicle profiles to ensure that any relevant settings are updated in the GNSS receiver.

8.9 Atmospheric Altitude

Certus contains an internal atmospheric pressure sensor. This is used as an altitude aid in the filter. If Certus is mounted in an area subject to unusual pressure waves, for example helicopters, or is mounted inside an enclosure that is not exposed to atmospheric pressure, the pressure sensor input should be disabled. This can be done by disabling Atmospheric Altitude in the [9.1.3.2 Filter Options](#) page in the web UI or the [9.2.7.3 Filter Options](#) dialogue in the Certus Manager.

8.10 Odometer Pulse Length

For Certus to use a wheel speed sensor or odometer input, it must know the pulse length of the signal. The pulse length is the distance in metres between low to high transitions of the signal. By default, the odometer will automatically calibrate itself. To automatically calibrate the odometer pulse length, see [8.10.1 Calibrating Odometer Automatic Pulse Length](#).

8.10.1 Calibrating Odometer Automatic Pulse Length

1. Ensure that the signal is connected correctly and that the GPIO pin is configured as an odometer input using the [9.1.3.6 GPIO](#) page in the web UI or the [9.2.7.7 GPIO](#) dialogue in the Certus Manager.
2. Open Certus Manager, connect to Certus and open the Odometer Configuration dialogue. In the **Odometer Configuration** dialogue select the **Automatic pulse length calibration** check box and click **Save**.
3. Wait until Certus has a continuous GNSS fix and then conduct the test in an area with no obstructions over the test circuit.
4. If Certus loses a GNSS fix for any extended period of time during the calibration, the distance travelled will be reset. The distance travelled can be checked in the Odometer Configuration dialogue to ensure that it has passed 1,000 metres.
5. Once 1000 metres has been driven, check that the automatic pulse length check box has become un-ticked and the Pulse Length value has changed. This indicates a successfully completed calibration.

Note: To enter the pulse length manually, use the [Odometer](#) page in the Configuration menu in the [Certus Manager](#).

8.11 Reversing Detection

Reversing detection is an algorithm that can detect when the vehicle is travelling backwards. Knowledge of reverse motion is important when using velocity heading or odometer input to provide correct results. If Certus is fitted to a vehicle that does not reverse or doesn't use velocity heading or an odometer, this function should be disabled. Reversing detection is enabled by default and it can be disabled using the Filter Options page in the web UI or Certus Manager. See [9.1 Using the Web User Interface](#) or [9.2 Using Certus Manager](#).

8.12 Motion Analysis

Motion analysis is an artificial intelligence algorithm that associates patterns in high frequency inertial data with the speed of the vehicle. After power on it takes some time to match patterns with speed before it will become active. Motion analysis only activates when dead reckoning and is most effective when the vehicle is near

stationary. Motion analysis does not work in all situations and its primary benefit is for ground vehicles. It should be enabled in any car application. Motion analysis is enabled by default and can be disabled using the [9.1.3.2 Filter Options](#) page in the web UI or the [9.2.7.3 Filter Options](#) dialogue in the Certus Manager.

8.13 RTK

The Certus internal GNSS receiver supports RTK GNSS which uses correction data (RTCM messages) from a nearby base station to provide accuracy of up to 0.01 m in real time. An RTK system requires additional infrastructure equipment to generate and receive corrections data, and is not practical for all applications. Customers who require this level of accuracy but do not need it in real time should consider using [Kinematica](#).

There are two different methods for receiving RTK corrections:

- Network
- Radio modem

For applications where Certus can achieve internet access, network RTK corrections (NTRIP) are recommended.

For applications that are unable to access the internet, radio modems can be used to communicate between Certus and the base station, see [8.13 RTK](#).

Note: If you do not need high accuracy positioning in real time, for example if you are planning to use Kinematica to post-process log files, an RTK system may not be necessary at all.

8.13.1 Network RTK Corrections (NTRIP)

NTRIP can be configured in three ways:

1. Using the Certus Web UI [9.1.3.13 NTRIP Client](#) in the Configuration Menu.
2. Using the Certus Manager application, select [9.2.8.6 NTRIP Client](#) under the Tools menu.
3. Using the Spatial Manager for Android application. This is convenient for field testing or when temporary RTK corrections are required, for example for performance trials. Download from the [Google Play](#) store.

Any of these NTRIP clients can connect to a network RTK service to stream RTK corrections to Certus. This requires that the client is connected to the internet, and a valid subscription with a local network RTK service. Contact [Support](#) if you need assistance in setting up for network RTK corrections.

8.13.2 Radio Modem RTK Corrections



Figure 25: Trimble R4 Base Station



Figure 26: Trimble TDL 450L Radio Modem

Base station radio modem RTK corrections require both a base station and a radio modem receiver. The base station is set up at a fixed location and transmits corrections to the radio modem receiver that is connected to the mobile Certus unit (the “rover”). The radio modem receiver and Certus unit must remain within radio range of the base station to receive these corrections. The base station should be located no more than 50 km from the Certus, and ideally closer. Advanced Navigation recommends contacting a local surveying company for assistance setting up a base station.

8.13.3 Supported RTCM Messages

The internal GNSS receiver in Certus supports receiving the following RTCM v3 messages.

Message Number		
1002	1010	1045
1004	1012	MSM4
1005	1019	MSM5
1006	1020	MSM6
1007	1033	MSM7
1008	1044	

Table 29: Supported RTCM v3 messages

8.14 Raw Satellite Data

Certus supports the output of raw satellite data. This data can be used by post-processing software to achieve high-accuracy kinematic positioning.

The maximum output rate for raw satellite data is 20 Hz, subject to the [9.1.3.16 GNSS Configuration](#).

It can be enabled by turning on the [11.4.38 Raw Satellite Data Packet](#) (ID 60) in the [9.1.3.3 Data Ports](#) page in the Web UI, or via the Packet Rates dialog in the **Configuration** menu of the Certus Manager, see the figure below.

This packet will be automatically converted to RINEX v3.02 by the [9.2.8.5 Log Converter](#) utility in the **Tools** menu of the Certus Manager.

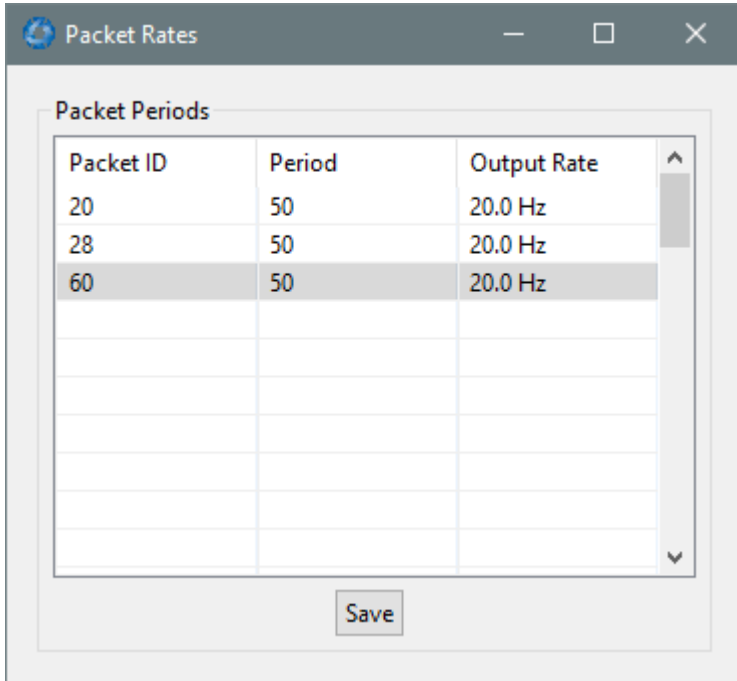

Figure 27: Enabling Packet 60

8.15 Kinematica Post Processing

Certus can be used with Advanced Navigation’s post-processing platform Kinematica to achieve high-accuracy positioning of as low as 10 mm and significantly improved dead reckoning performance. You need to record a ANPP-format log file with certain packets enabled.

Refer to the Kinematica documentation found at www.advancednavigation.com/solutions/kinematica for details.

8.16 Vents

Certus contains a sophisticated venting system that allows it to measure air pressure whilst preventing water ingress. There are two sets of vent holes on either side of the enclosure. It is very important that these remain clear of debris and blockages. Should debris get into the vents they should be gently rinsed with fresh water. Foreign bodies should never be poked into the vent holes, as this will break the environmental seal and void the warranty on the unit. The vents are not resistance to high-pressure jet washing or to waves. Do not direct streams of water directly at the unit.

8.17 RAIM

RAIM stands for Receiver Autonomous Integrity Monitoring. It allows a GNSS receiver to detect and exclude both faulty and fraudulent satellite signals. The Certus internal GNSS receiver is equipped with RAIM and it is

enabled by default.

An improved class of RAIM, Fault Detection and Exclusion (FDE), is used in some GNSS receivers. The objective of FDE is to detect positioning failure and exclude the source of failure; however, it may not identify the specific source. FDE uses a minimum of six satellites to detect and exclude a possible faulty satellite from the navigation solution to ensure that the navigation function remains uninterrupted.

The availability of RAIM and FDE might be slightly lower for mid-latitude operations and slightly higher for equatorial and high-latitude regions because of the nature of the orbits. The availability of RAIM and FDE can be enhanced by using satellites from multiple GNSS constellations or using SBAS satellites as additional ranging sources.

8.18 Heave

Certus can provide vertical heave position at four different points on a ship. The Certus heave filter is always on and fully automatic. After power on, Certus requires approximately 5 minutes for its heave filter to converge upon an accurate solution. Heave works without a GNSS fix, however best heave performance is achieved when Certus has a GNSS fix .

By default Certus provides heave from the point at which the Certus unit is mounted, however it can provide heave at four different offset points on the ship. To configure Heave, see the [9.1.3.9 Reference Point Offsets](#) page in the web UI or use the [9.2.7.10 Reference Position Offsets](#) dialogue in the Certus Manager.

8.19 Environmental Exposure

Whilst Certus is environmentally protected, there are limits to this protection that must be observed to avoid damaging the device.

Certus is only IP67-protected when its connectors are mated (or sealed with the blanking caps) and two IP67 GNSS antennas are attached to it (or the antenna ports are sealed). If any of these connections are not tightened to the recommended torque, the unit will not achieve its rated protection.

Spanners or tools should never be used to tighten the connectors. Use your fingers to firmly tighten the connectors. The Certus seals the top of the enclosure to the base using screws and an o-ring. This o-ring is not field serviceable, and attempting to open the housing will invalidate the calibration.

8.19.1 Temperature

Certus should not be subjected to temperatures outside of its operating range. Subjecting Certus to temperatures outside of the operating range can affect the factory sensor calibration, potentially causing a permanent reduction in performance or premature failure. For information about the operating temperature range, see [6.3 Hardware Specifications](#).

8.19.2 Water

Certus complies with IP67 standard, which means that it can be submersed in water to a depth of up to 1 m deep for a maximum of 30 minutes. Submersion to depths beyond 1 metre can cause water entry and destruction of the internal electronics, and the sealing is not designed for prolonged or repetitive immersion. Do not direct streams of water directly at the unit even at low pressure. For cleaning the unit, ensure that no pressure is used.

Note: Connectors must be installed or blanking caps must be used if the unit is likely to be exposed to water.

8.19.3 Salt

The Certus housing is made from hard-anodized marine-grade aluminium and stainless fittings to provide good corrosion resistance, however cannot tolerate extended periods of time in salt water environments. After any contact with salt water or salt spray, Certus should be rinsed with distilled or RO water.

8.19.4 Dirt and Dust

Certus is completely sealed against dirt and dust entry whenever all connectors are mated. When disconnecting the connectors, any dirt or dust should be rinsed or wiped off with fresh water and then dried to minimise the chance of contaminants entering the connectors or plugs.

8.19.5 pH Level

Environments with acidic or alkaline water or atmospheres can cause the Certus enclosure to corrode or discolor. If Certus comes into contact with these environments it should be rinsed in fresh water as soon as possible. It is not recommended to operate Certus in non-neutral pH environments.

8.19.6 Shocks

Certus is a rugged piece of equipment that can withstand reasonable amounts of shock. However, continuous shocks may cause premature failure as a result of materials fatigue, and may also affect the sensor calibration resulting in degraded performance.

Shocks applied directly to the Certus enclosure can affect the unit. Therefore, care should be taken when handling the unit prior to mounting. When mounted in a vehicle, the effect of most operating shocks is negligible.

8.19.7 Atmospheres

Hydrogen-rich atmospheres may damage the MEMS. Certus is not rated for use where explosive gases or dust may be present.

8.20 Upgrading the Certus Firmware

Certus contains firmware which is regularly updated to improve performance and add features. Advanced Navigation recommends that you upgrade to the latest version whenever available. The firmware update function is robust, such that power loss, file corruption or other issues cannot cause problems with units. Check the [Certus](#) product page of the Advanced Navigation website periodically for updates.

Note: Advanced Navigation device firmware files have the extension .anfw.

See [9.2.8.3 Firmware Update](#) for instructions on how to upgrade the firmware using the Certus Manager or see [Firmware Update](#) for instructions to update the firmware using the web UI.

9 Configuring and Monitoring Certus

Certus can be configured and monitored through:

- the [web user interface](#), accessed on a connected computer via Ethernet
- Certus [Manager](#), accessed on a computer via a serial adaptor
- the [Android App](#)
- the Advanced Navigation Packet Protocol ([9.4 Using ANPP](#))

The Certus Web UI is the recommended interface to configure as it is designed to be simple and easy to use without any software or system requirements. The Web UI is compatible with all modern web browsers.

9.1 Using the Web User Interface

The web user interface allows you to manage Certus through the following:

- [9.1.1 Main View](#)
- [9.1.2 View Menu](#)
- [9.1.3 Configuration Menu](#)
- [9.1.4 Tools Menu](#)

9.1.1 Main View

The Main View is accessible from other pages via the **Map** menu item under the **View** menu.

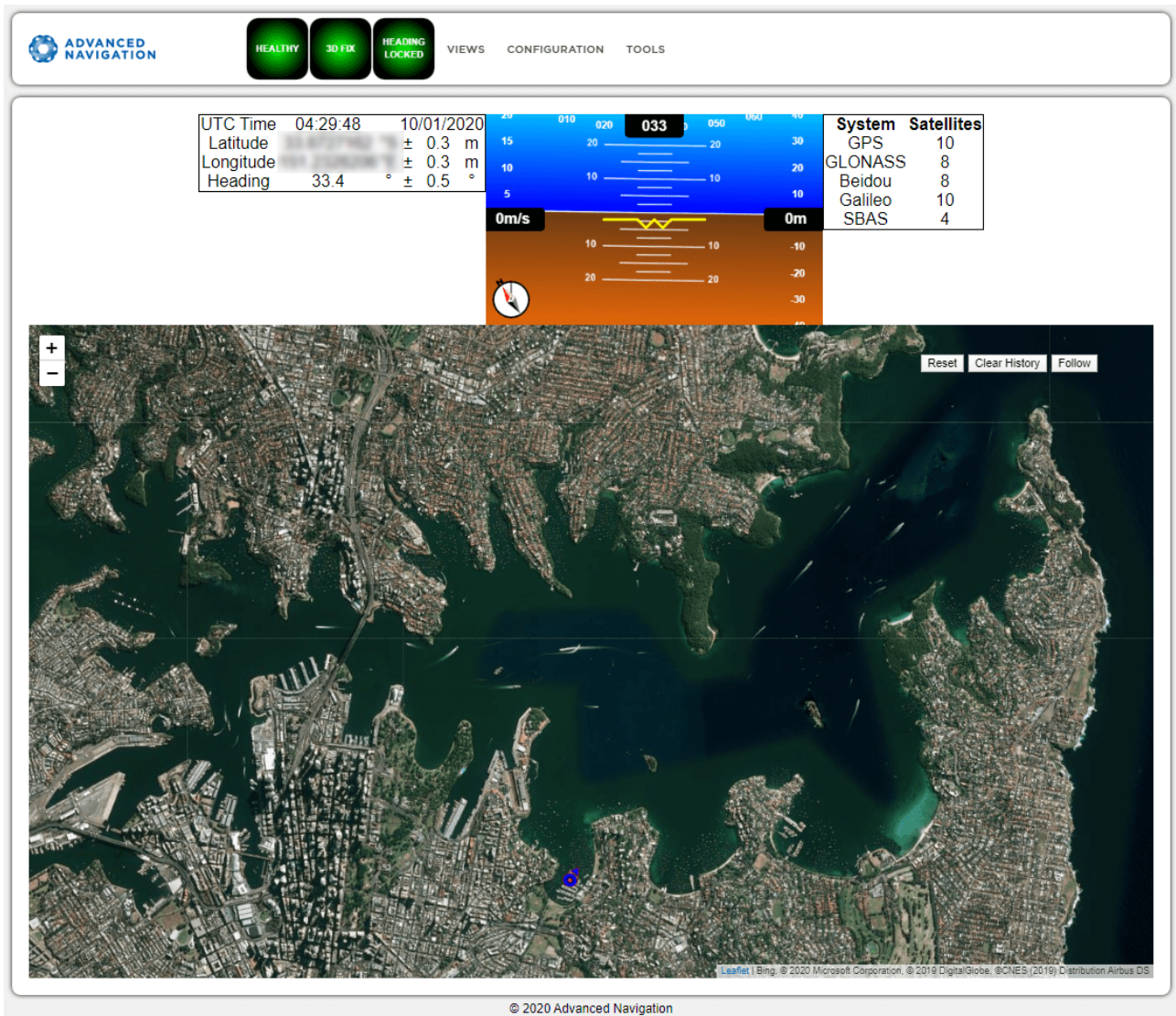

Figure 28: Certus Web UI Home Page

9.1.1.1 Status Indicator

The Status Indicator section contains the current Certus status, the GNSS fix type indicator, and the heading status. These are visible on every page.

- Status Indicator: This indicator shows any problems with Certus. Once the filter has initialised it will show “HEALTHY”.
- GNSS Fix: This indicator shows the status of the GNSS fix. Under normal operating conditions it should show “3D FIX”. When satellite visibility is poor it may show either “2D FIX” or “NO FIX”.
- Heading Status: This indicator shows the current status of the heading filter. When there is a valid source of heading it will show “HEADING LOCKED”.

9.1.1.2 Current Time, Position and Heading

This section displays the current UTC time, position, and heading. The data will only be valid if Certus has a HEALTHY status, there is a 3D GNSS fix or better, and the Heading is initialised.

9.1.1.3 Altitude Indicator

The Attitude Indicator visualises roll and pitch using a standard artificial horizon. Heading, velocity and height are shown to the side. All units are SI (metric) and degrees.

9.1.1.4 Satellites Table

The Satellites table shows the number of satellites visible by the primary antenna. More detailed information can be found in the Satellites screen under the **View** menu.

9.1.1.5 Map

The map shows the Certus position on Earth as well as a red trail showing position history since the last reset. When the filter initialises the map will automatically reset the view to the Certus position. To move the camera click and drag on the map. To zoom in and out, use the mouse scroll wheel.

Use **Reset** to reset the map view to the current position of Certus.

Clear History clears the current red trail showing the position history. This will immediately restart from the current position. Note that this does not affect any logging currently active.

9.1.1.6 Map Controls

Reset

This resets the map view to the current position of Certus.

Clear History

This clears the current red trail showing the position history. This will immediately restart from the current position. Note that this does not affect any logging currently active.

Follow

This button makes the map follow the device.

9.1.2 View Menu

The View menu contains the options for viewing pages of data from Certus.

9.1.2.1 Map

This takes the user back to the home page of the web UI with the map display.

9.1.2.2 Device Information

The Device Information page is useful for users when requesting technical support and for tracking their serial number, firmware version, and hardware version.



Figure 29: Certus Web UI Device Information Page

9.1.2.3 Subcomponent Information

The Subcomponent Information page shows the serial numbers and hardware version information for the Certus subcomponents. This will be useful information to include when contacting our support team.

9.1.2.4 Status

The Status shows the current status of Certus as reported by sections [11.4.1 System State Packet](#) (ID#20) and [11.4.10 Raw GNSS Packet](#). (ID#29).

Note: The following Status flags do not update for Certus units with a Trimble BD992 GNSS Receiver. These flags are only applicable to Aries GNSS Receivers: GNSS 2, Antenna 1 disconnected, Antenna 2 disconnected, Antenna 1 short, Antenna 2 short

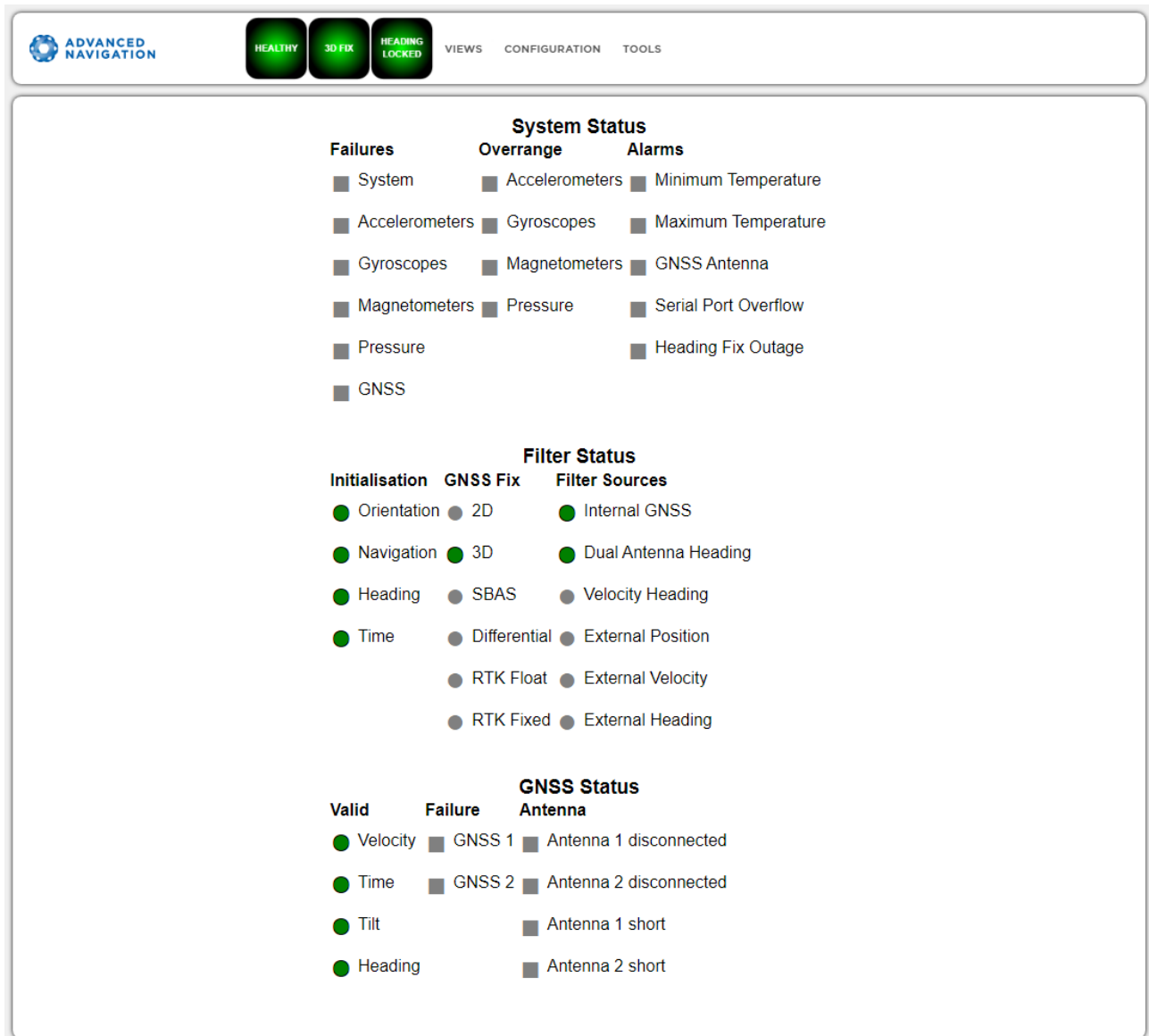

Figure 30: Certus Web UI Status Page

9.1.2.5 Satellites

The Satellites page shows detailed information on the satellites that are visible to both antennas of the Certus GNSS receiver.

The information is displayed as a satellite skyplot, a table and an SNR graph. A maximum of 28 satellites will be displayed, even if more are accessible. This plot shows the SNR of each satellite at the primary and secondary antenna. As a guideline, these should be within 5-10 dB of each other in the absence of cable or antenna faults

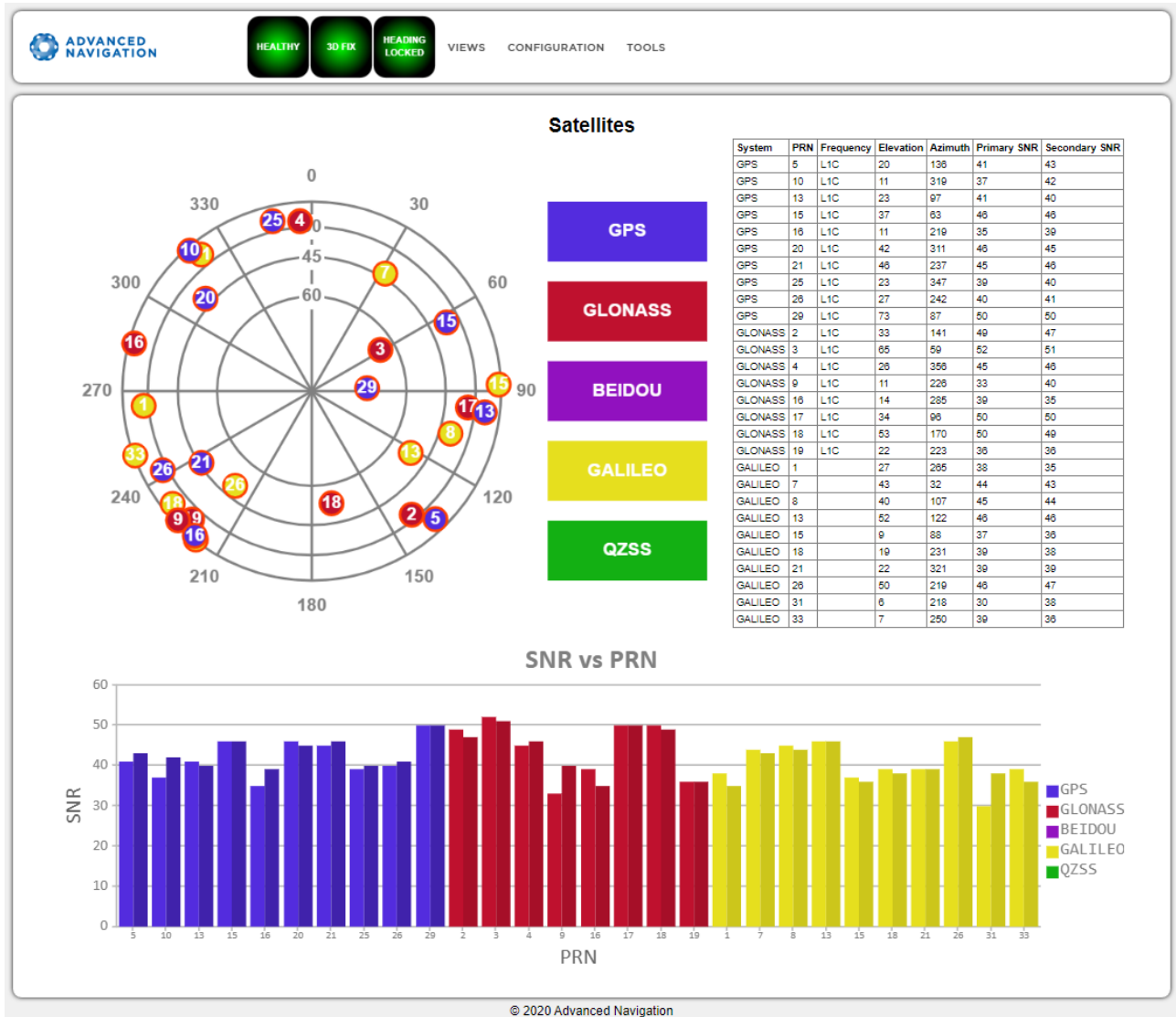

Figure 31: Certus Web UI Satellites Page

9.1.2.6 Raw Sensors

The Raw Sensors page shows the temperature-calibrated raw IMU sensor values. In the lower plot only the air pressure is plotted. The current value from the internal temperature sensors are given on the right. These do not provide general environmental temperature.

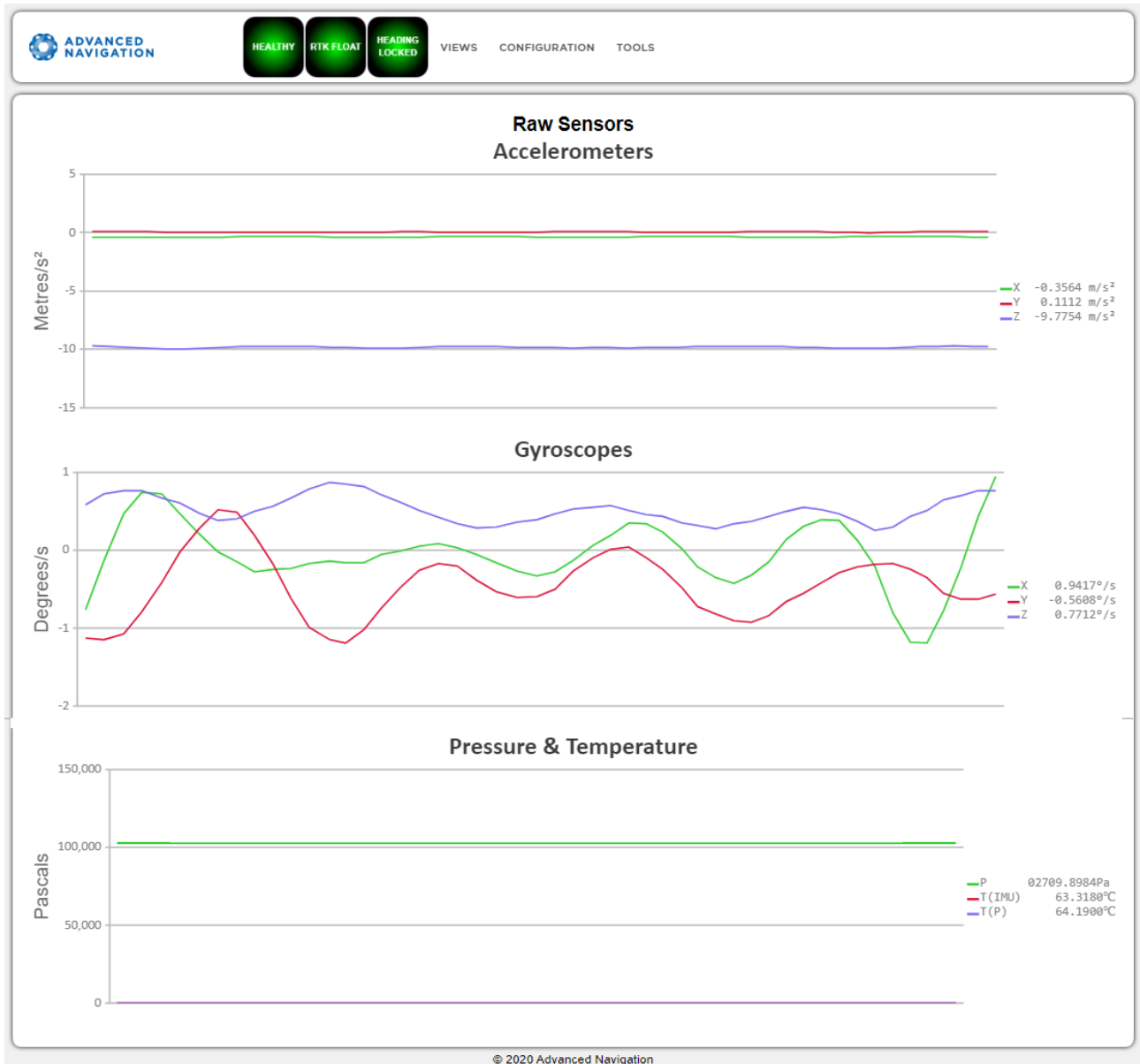

Figure 32: Web UI Raw Sensors Page

9.1.2.7 Orientation

The Orientation page shows the Certus orientation and angular velocity. Course is determined by measuring sequential positions. Slip is the difference between the heading and the course.

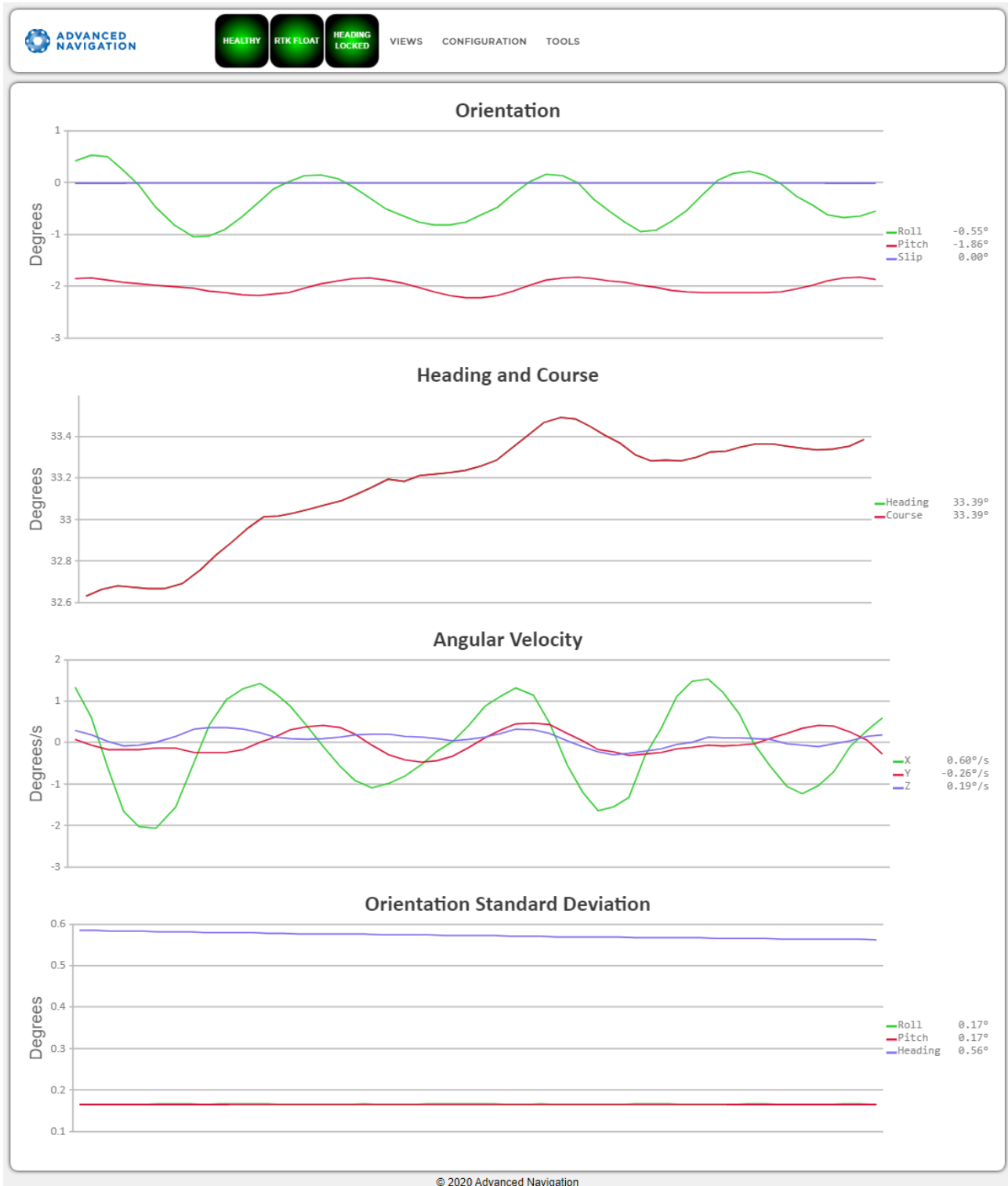

Figure 33: Certus Web UI Orientation Page

9.1.2.8 Position

The Position page shows the Certus position and position standard deviation. Latitude and longitude are converted to North and East metres from a reference point that can be reset by refreshing the web page in your browser.



Figure 34: Certus Web UI Position Page

9.1.2.9 Velocity and Acceleration

The Velocity and Acceleration page shows the Certus velocity, acceleration and g-force.

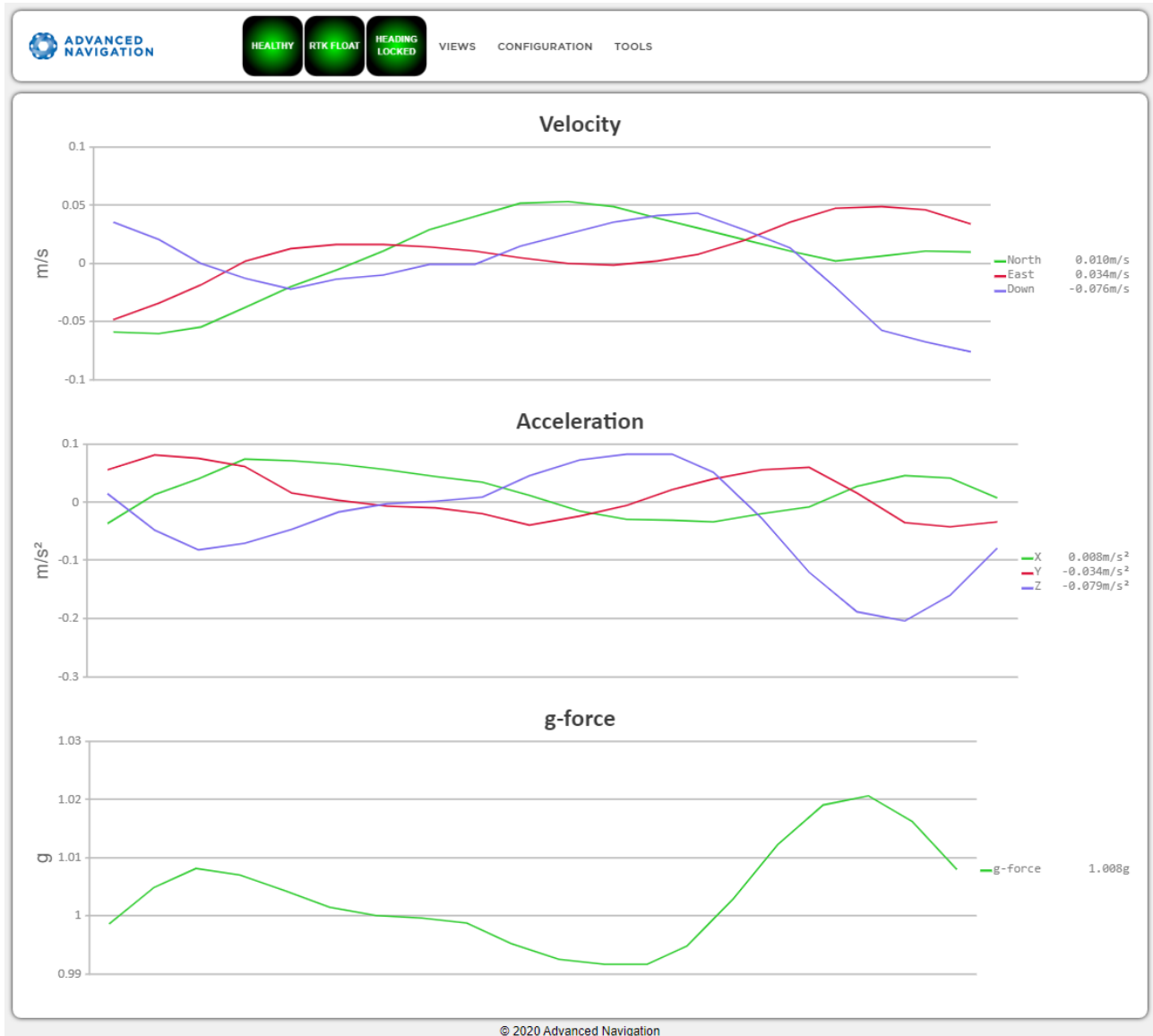

Figure 35: Certus Web UI Velocity and Acceleration Page

9.1.2.10 GNSS Receiver Information

This page shows information about the GNSS receiver fitted to Certus.

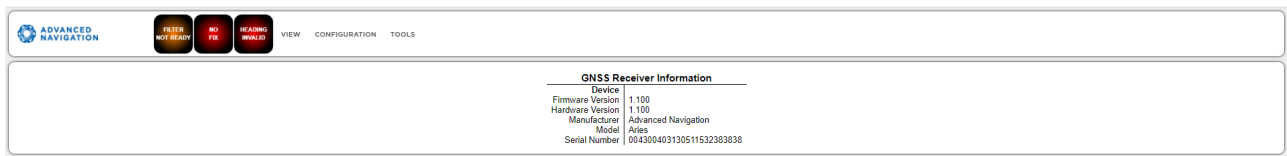

Figure 36: Certus Web UI GNSS Receiver Information Page

9.1.2.11 Heave

This page displays the heave at up to 4 reference points.

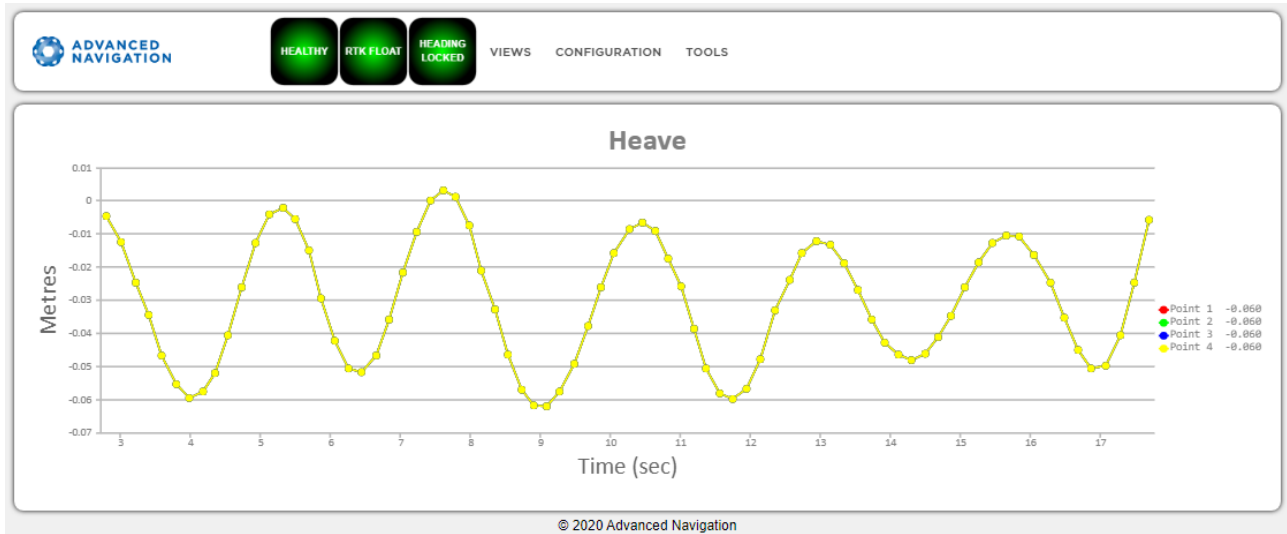

Figure 37: Certus Web UI Heave Page

9.1.3 Configuration Menu

These menus contain the set of configuration settings for Certus.

9.1.3.1 Sensor Ranges

Note: The sensor range can only be modified for Certus. Certus Evo only offers a fixed sensor range. See [6.1 Navigation Specifications](#) for sensor range specifications.

The Sensor Ranges page is used to set the dynamic range of the sensors. If you are experiencing over-range events during operation, these settings should be used to increase the range of the sensor which is reporting the over-range. The lowest ranges give the best performance, so make changes slowly and monitor the results.

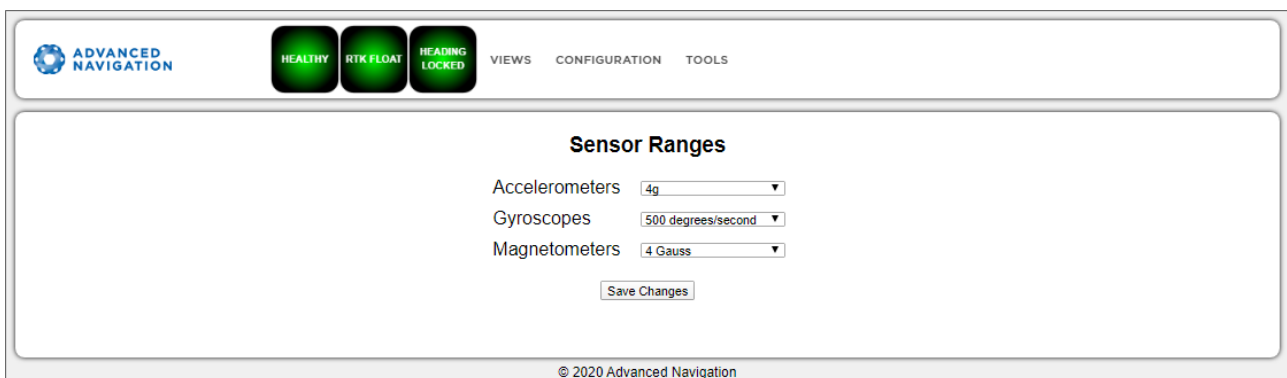

Figure 38: Certus Web UI Sensor Ranges Page

9.1.3.2 Filter Options

Ensure that the Vehicle Type filter option is selected for all applications. For most standard applications, the other filter options can be left as their defaults.

See [8.1 Filter Initialisation](#) for more information on these specific settings. If you require assistance, contact support@advancednavigation.com.

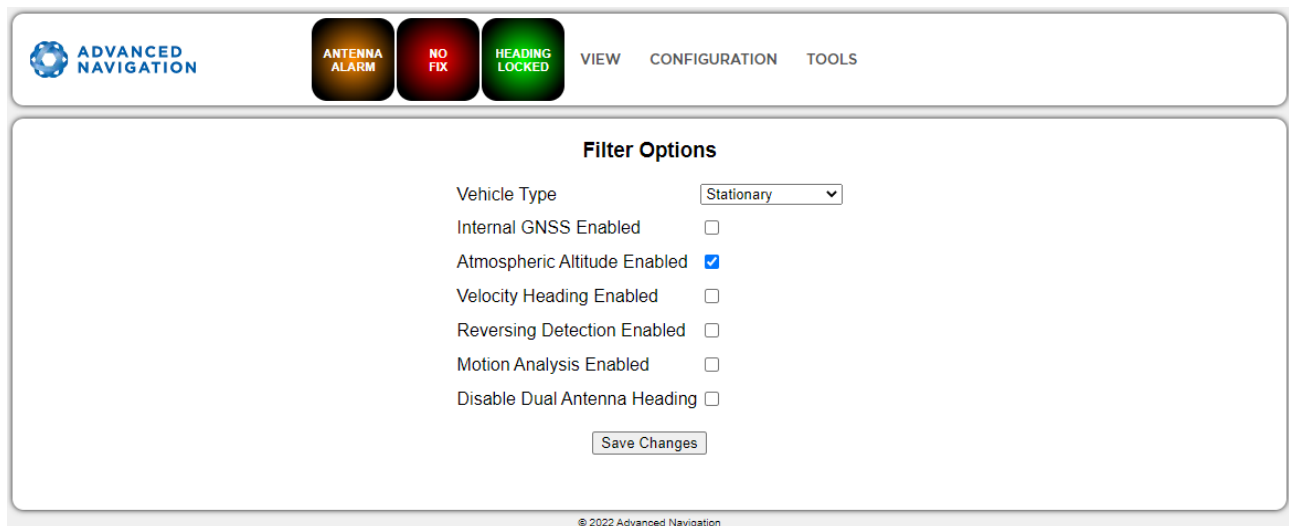

Figure 39: Certus Web UI Filter Options Page

9.1.3.3 Data Ports

The Data Ports page allows you to specify which data packets or messages are output on a periodic basis and at what rate via a range of serial and Ethernet ports.

Note: The GPIOs and auxiliary port are configured in the Data Ports page only if they are being used as serial transmit and receive lines. To configure GPIOs as digital or frequency inputs or outputs, use the [9.1.3.6 GPIO](#) page.

The default ANPP format packets enabled for the primary port are the [11.4.1 System State Packet](#) (ID #20) and the [11.4.9 Raw Sensors Packet](#) (ID #28) at 20 Hz and these typically provide all the data that a user will require. Other ANPP format state packets can be enabled as required.

Other data formats available include NMEA0183, GNSS, TSS1, SIMRAD and other formats. For more information see [10.1.2 Ethernet Functions](#) and [10.2 Serial Interface](#).

ADVANCED NAVIGATION

HEALTHY

RTK FLOAT

HEADING LOCKED

[VIEWS](#) [CONFIGURATION](#) [TOOLS](#)

Data Ports

Primary

Packet:

Packet:

Output

Period: ms

Period: ms

Frequency: 20.00hz

Frequency: 20.00hz

Auxiliary

Output

Input

GPIO

Output

Input

Ethernet 1

Mode:

Output

Input

Port:

Ethernet 2

Mode:

Output

Input

Port:

Ethernet 3

Mode:

Output

Input

Port:

Ethernet 4

Mode:

Output

Input

Port:

Logging

Output

Figure 40: Certus Web UI Data Ports Page

9.1.3.4 Alignment

The Alignment page is used to set the alignment offsets of the system installation. It is important to set the values on this page correctly to avoid degrading performance.

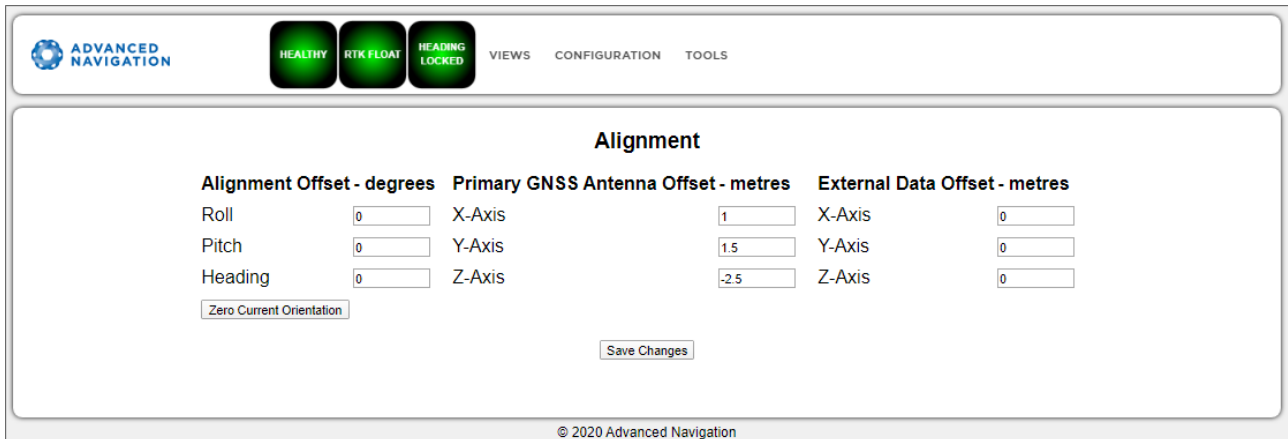

Figure 41: Certus Web UI Alignment Page

Alignment Offset

If Certus is installed into the vehicle with the positive X axis pointing forwards and the positive Z axis pointing down, then no alignment offset is required and the roll, pitch and heading offset values can remain at the factory defaults of zero.

If the unit is installed in a different orientation then the roll, pitch and heading offset must be entered. For example, if the unit is installed on its side with the X axis pointing up and the Z axis pointing forwards and no change to the Y axis, then this would result in a pitch offset of +90 degrees with roll and heading remaining zero.

If there is a small misalignment due to mechanical mounting error this can be compensated for by setting the vehicle stationary on a level surface and clicking the **Zero Current Orientation** button.

Note: Zero Current Orientation will only correct for roll and pitch offsets, the Heading offset must be entered manually and saved after using this function.

GNSS Antenna Offset

The GNSS antenna offset is measured from the centre of the Certus unit to the phase centre of the primary antenna in the orientation of the [12.3 The Body Co-ordinate Frame](#) (X positive forward, Z positive down).

External Data Offset

These values are only required for speciality applications operating with an external source of velocity and position data. The offsets are used when providing NMEA Input, External GNSS, or with an Air Data Unit. When using a DVL, use the odometer offset. Please contact support@advancednavigation.com for further assistance.

9.1.3.5 Baud Rates

This page is for setting the baud rates for the GPIO, primary and auxiliary ports. The factory default baud rate value for these ports is 115200 bps.

The primary and auxiliary ports can be set to RS232 or RS422. The factory default is RS232 for both ports.

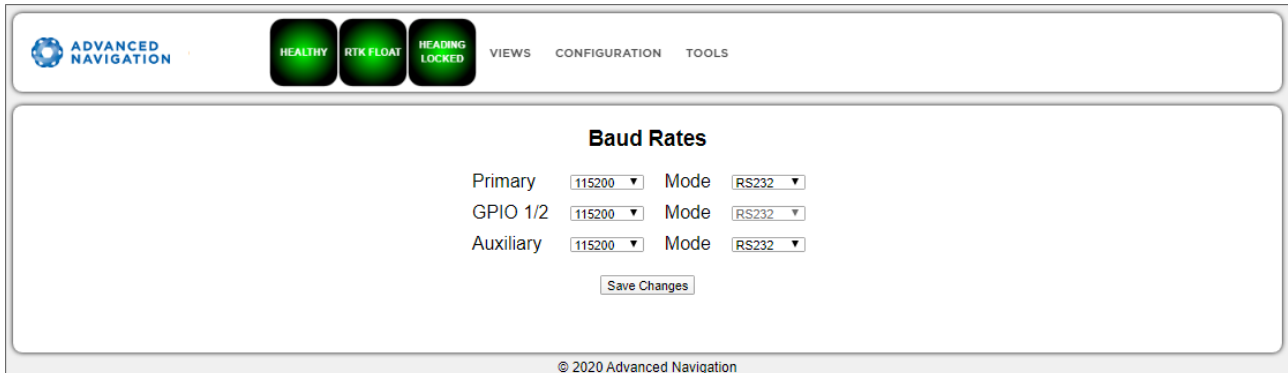

Figure 42: Certus Web UI Baud Rates Page

9.1.3.6 GPIO

This page allows the user to select the input and output functions of the GPIO and Auxiliary ports. These functions are described in detail in [10.6.1 Dynamic Pin Functions](#). These functions change dynamically and are effective immediately upon clicking **Save Changes**.

Note: The GPIO port functions at RS232 levels for data functions and 0 to 5 volt (or 0 to 3.3 V) levels for all other functions. The auxiliary port functions at RS232 or RS422 levels for data functions and 0 to 5 volt (or 0 to 3.3 V) levels for all other functions. The internal hardware automatically reconfigures based upon the selected function.

The default values for these settings are Inactive. The dedicated 1PPS signal is active by default.

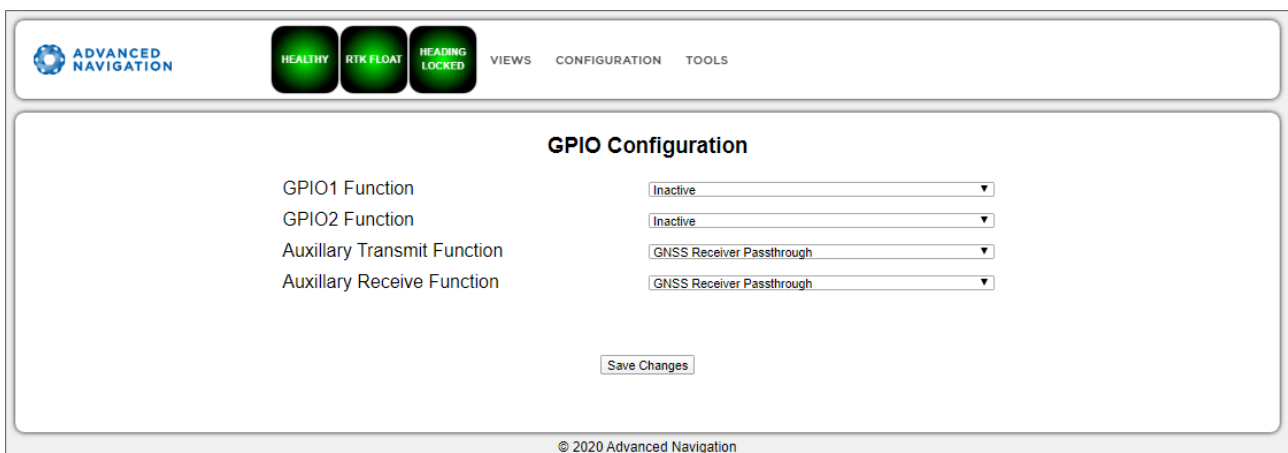

Figure 43: Certus Web UI GPIO Configuration Page

9.1.3.7 Odometer

The Odometer page allows the user to configure the odometer pulse length and offset. See [7.7 Odometer](#) and [8.10 Odometer Pulse Length](#) for more information on the use of odometers. The odometer offset is also

applied when using a DVL input.

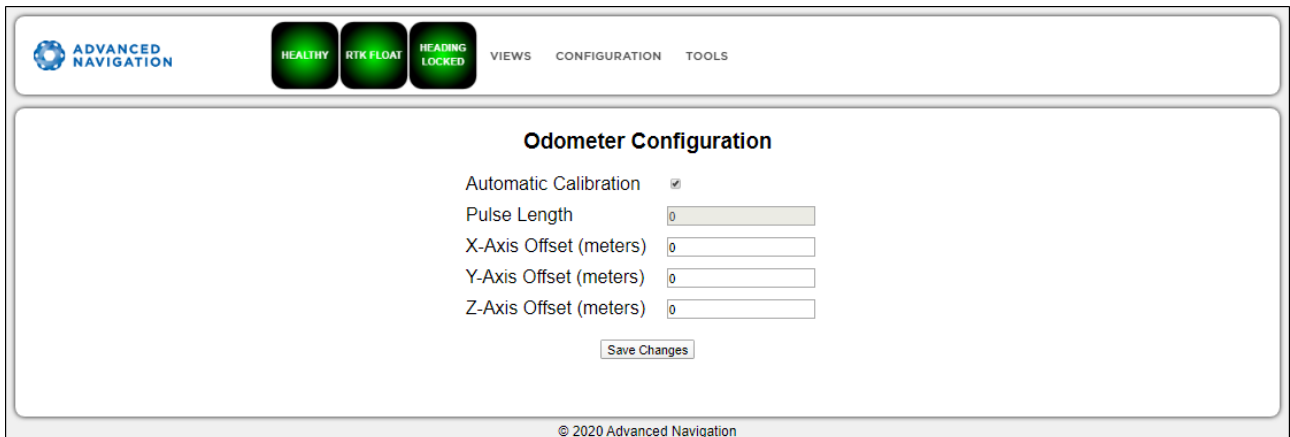

Figure 44: Certus Web UI Odometer Configuration Page

9.1.3.8 Reset

The Reset button causes the system to perform a power cycle. No configuration settings or state data are lost.

The Cold Start button clears all filters, and connections are reset and must re-established. No configuration settings are lost.

The Factory Reset button resets all Certus settings back to their factory defaults, including state data and all configuration settings. It also erases the hot start data so that the system is forced to perform a cold start.

Note: A Factory Reset will re-enable the DHCP Client and lose any static IP address settings.

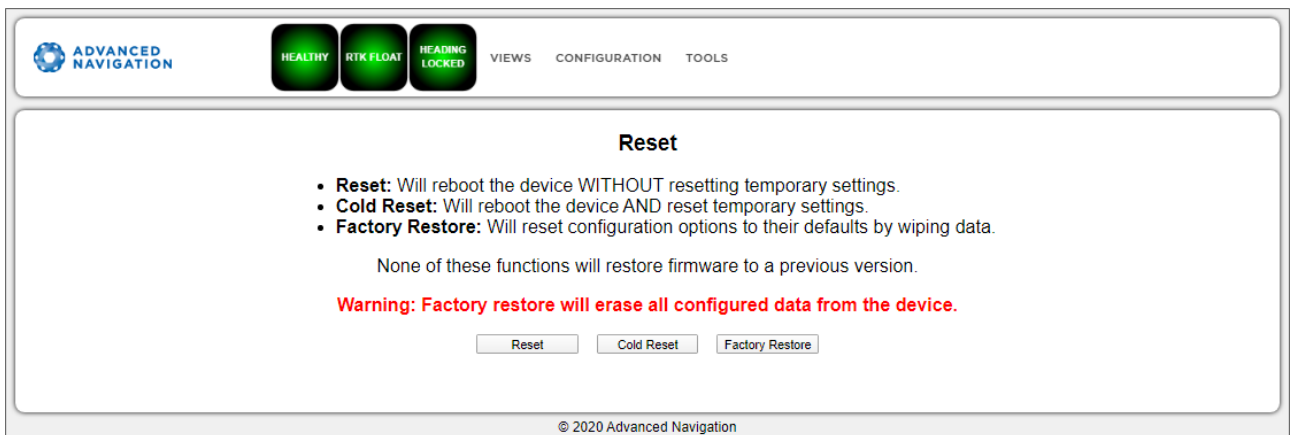

Figure 45: Certus Web UI Reset Page

9.1.3.9 Reference Point Offsets

The Reference Point Offsets page allows the user to set measurement points away from its default position at the physical centre of the Certus unit. The primary reference point offset applies to data from all ANPP packets as well as all peripheral output such as NMEA messages and Heave Point 1.

The Heave Points 2 to 4 allow the user to offset reference points for the heave values 2 to 4 in the [11.4.37 Heave Packet](#).

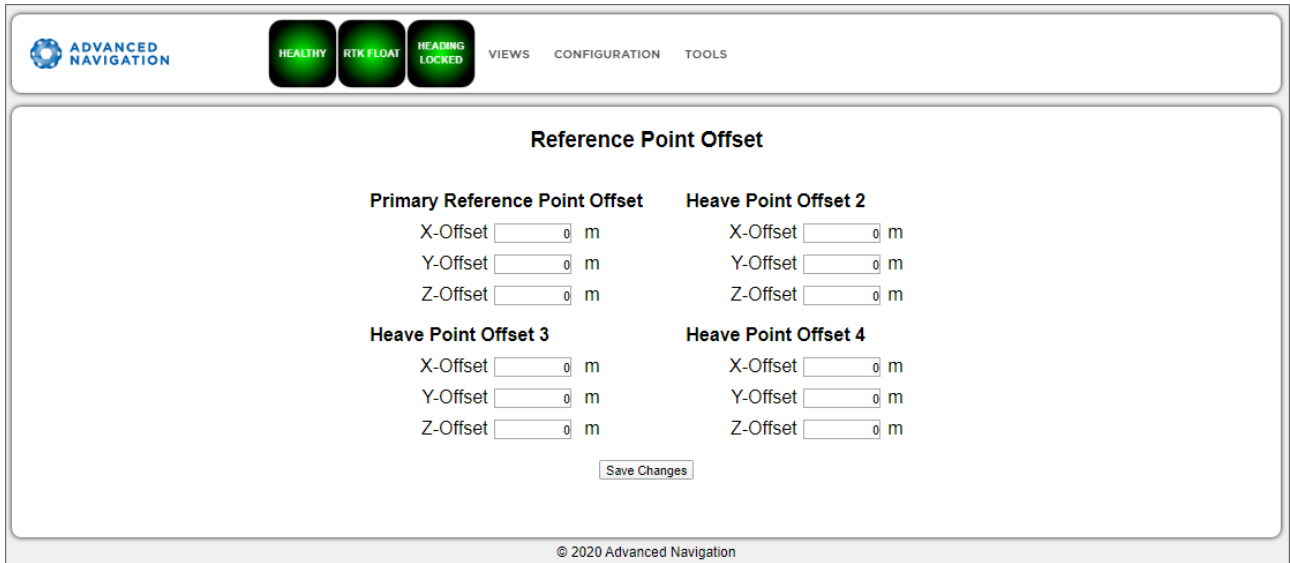

Figure 46: Certus Web UI Reference Point Offsets Dialogue

9.1.3.10 Manual Initialisation

This page can be used to manually initialise Certus when a GNSS fix is not available. Setting the position will initialise the navigation filter. Setting the heading will also initialise the heading filter.

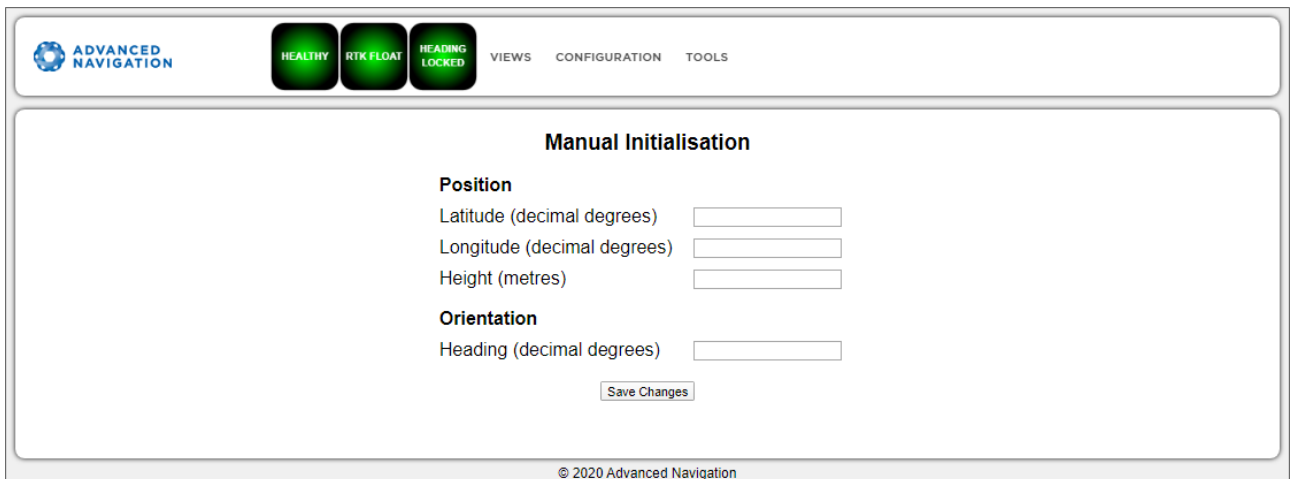

Figure 47: Certus Web UI Manual Initialisation Page

9.1.3.11 Dual Antenna

The Dual Antenna configuration page is only used if the primary and secondary GNSS antennas are not installed in their recommended and default positions of primary front and secondary rear, at the same height.

If it is not practical to mount the antennas in the recommended alignment, the alternate alignments must be entered into this page. It is recommended to try and use one of the automatic offsets where possible, where the antennas must be installed in one of four different automatic offset orientations aligned on an axis.

If it is not possible to use one of the automatic offsets, the antennas can be installed in any configuration and a manual offset should be entered. The manual offset is measured from the central base of the secondary antenna to the central base of the primary antenna in the body co-ordinate frame (X+ forward, Z+ down). If

using a manual offset, be careful to measure the offset accurately, as even small offset errors can result in relatively large heading errors e.g. 2 cm error = 1.15 degrees heading error with a 1 metre separation.

When using an automatic offset, the manual offset values are ignored.

When using a manual offset, the automatic offset selection is ignored.

When using automatic offset, the manual offset values will show the distance that Certus has automatically measured.

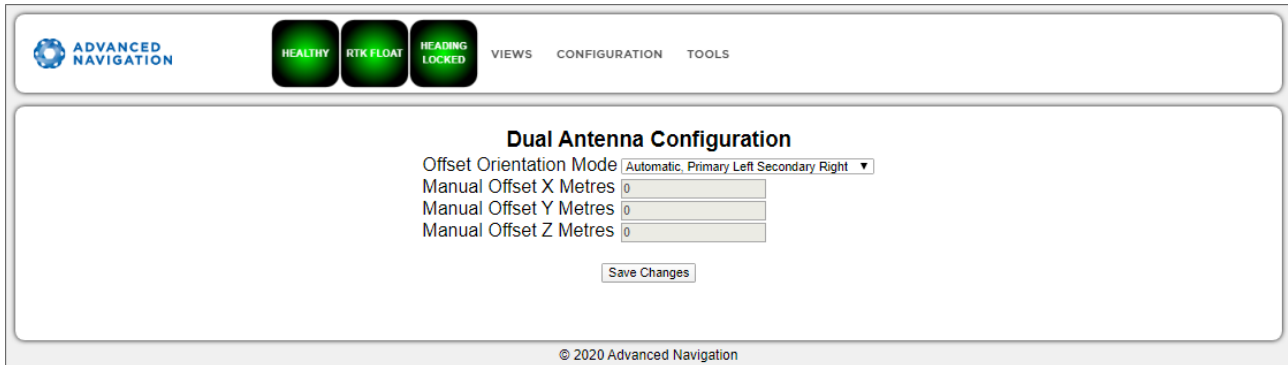

Figure 48: Certus Web UI Dual Antenna Page

9.1.3.12 Ethernet Settings

The Ethernet Settings page allows you to enable or disable the DHCP Client. When the DHCP Client is disabled you need to enter the TCP/IP settings if you wish to access the web UI.

If you are only connecting to Certus via the primary port these settings can be ignored.

The default is for the Ethernet mode to be set to DHCP.

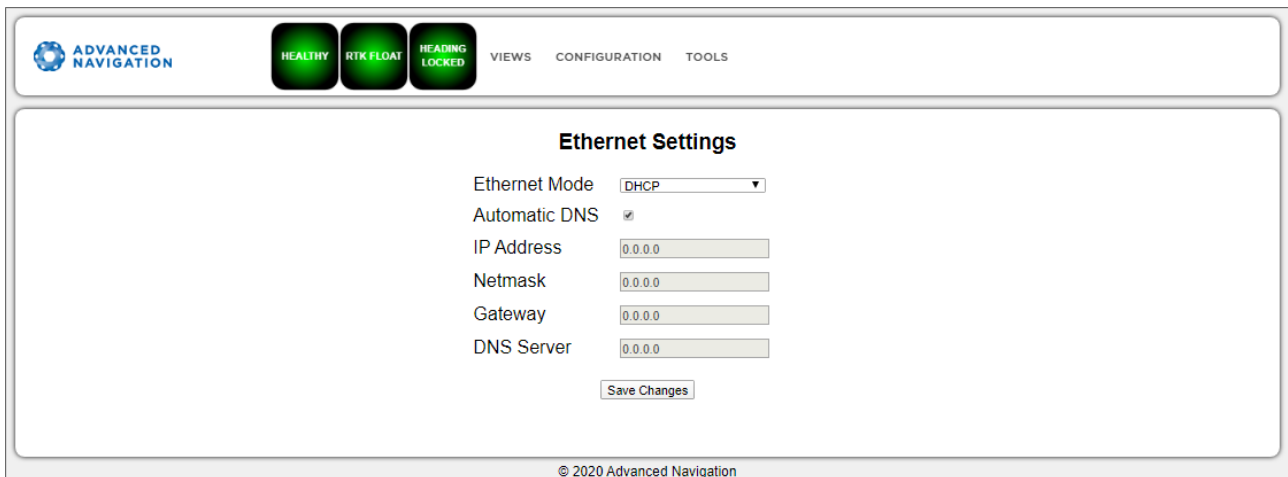

Figure 49: Certus Web UI Ethernet Settings page

9.1.3.13 NTRIP Client

The NTRIP client built into Certus can be used to connect to a network DGPS (Differential GPS, a older standard for GNSS corrections of lower performance than RTK) or RTK service to stream correction data to Certus for DGPS or RTK. The NTRIP client requires that Certus has an available internet connection to the NTRIP Caster to function.

The source of the corrections data can be either your own base station, configured as an NTRIP Caster, or a third-party service. Either way, you will need the login details for connecting to and authenticating with the NTRIP Caster, and identifying the nearest mountpoint.

These steps are required:

1. Select Enabled.
2. For Host/Server, enter the NTRIP Caster address.
3. For Port, enter the NTRIP Caster port number. This is usually 2101.
4. Click Save.
5. Click Get Mountpoints.
6. Select your mountpoint from the Mountpoint drop down list, being mindful that the distance should not exceed 50km.
7. Enter your username in the Username box.
8. Enter your password in the Password box.
9. Click Save.

To disconnect from the NTRIP Caster unselect Enabled and click Save.

Troubleshooting NTRIP Caster Connections

Some mountpoints require that Certus send its position. To do this, click the Report Position check box, and then click Save Changes. The current Certus position will then be sent to the NTRIP Caster every 10 seconds.

If you cannot get the list of mountpoints, ensure the Host Address and Port number are correct for your NTRIP Caster.

If the Connection Status is not green, and says UNAUTHORISED this indicates an incorrect username or password.

Contact support@advancednavigation.com for further assistance with network DGPS or RTK.

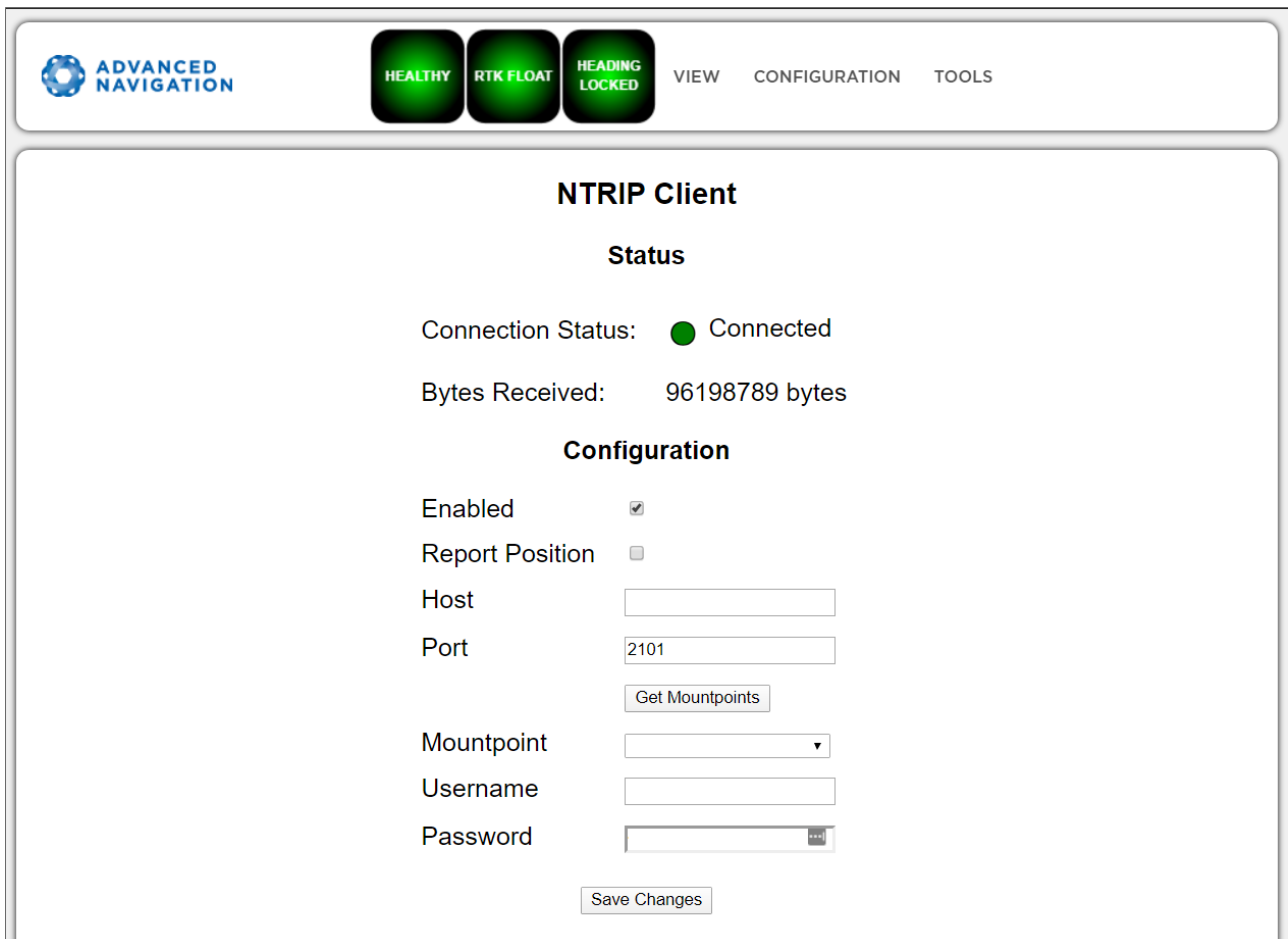

Figure 50: Certus Web UI NTRIP Client Page

9.1.3.14 CAN Settings

The CAN Settings page allows you to enable or disable the CAN functionality. If you are only connecting to Certus via the primary port then these settings can be ignored.

The default for CAN is Enabled at 1,000,000 baud rate. A CANOpen EDS file is available. Contact Support for a copy of this file.

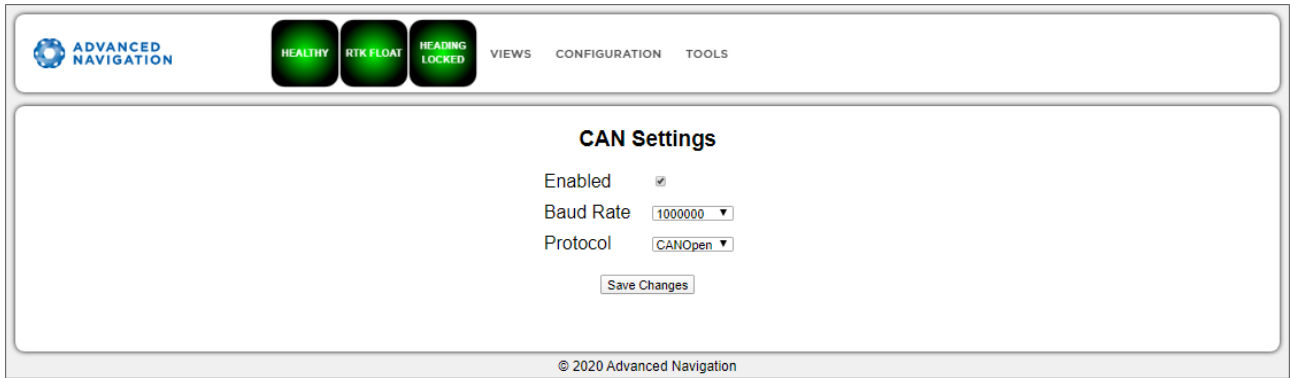

Figure 51: Certus Web UI CAN Settings Page

9.1.3.15 Advanced

The Advanced page allows you to set the voltage level of the GPIO and 1PPS signals lines along with the packet rates.

The options are 5 V, 3.3 V, or Disabled. The default is 5 V.

Note: The dedicated 1PPS signal is active whenever the voltage is set to 5 V or 3.3 V, and is therefore active by default.

The CANopen output packet rates can be configured as the period between packets in milliseconds within the range of 10 ms to 10,000 ms. The default is 50 ms.

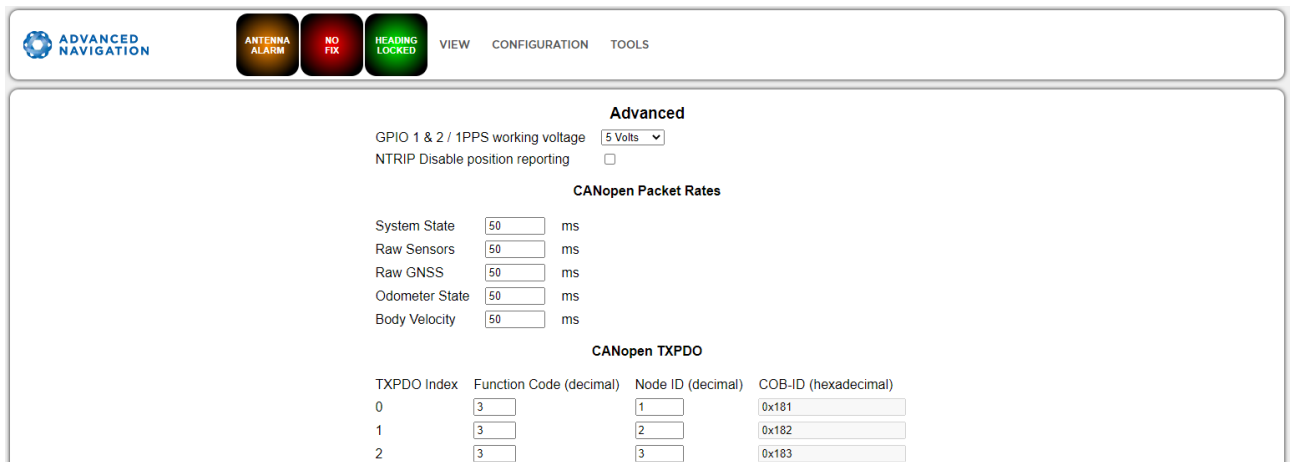

Figure 52: Certus Web UI Advanced Page

9.1.3.16 GNSS Configuration

The GNSS Configuration page allows you to select constellation configurations based on the type of GNSS receiver installed.

If an invalid configuration is entered, the system will revert to the previous configuration when you try to save the changes. To confirm that changes have been successfully saved, close and re-open the GNSS Configuration dialogue.

Aries GNSS Receiver

When using an Aries GNSS receiver, the following configuration rules are applicable:

- By default, GPS, Galileo and GLONASS are enabled, along with SBAS and QZSS correction services.
- When selecting a GNSS constellation, all frequencies for that constellation must be selected.
- SBAS and QZSS correction services can also be enabled for all constellation configurations, except when using GPS, Galileo and BeiDou together.

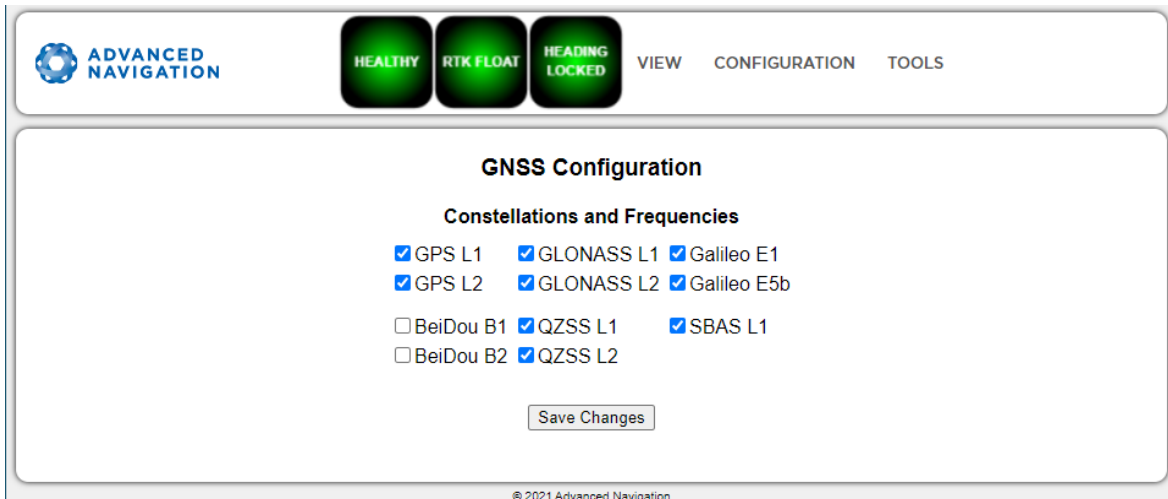

Figure 53: Certus Web UI Aries GNSS Configuration Page

The table below lists the supported constellations and the corresponding GNSS sample period depending upon the number of constellations selected. When setting the [9.1.3.3 Data Ports](#), the packet rate of the [11.4.10 Raw GNSS Packet](#) and [11.4.38 Raw Satellite Data Packet](#) are automatically adjusted to the next lower integer multiple of the sample period.

# of Constellations Configured	Sample Period	Example Effective Packet 60 Rate	Supported Constellation Configurations
1	50 ms	1 ms - 99 ms = 50 ms (20 Hz) 100 ms - 149 ms = 100 ms (10 Hz) 150 ms - 199 ms = 150 ms (6.67 Hz)	GPS Galileo GLONASS BeiDou
2	80 ms	1 ms - 159 ms = 80 ms = 12.5 Hz 160 ms - 239 ms = 160 ms (6.25 Hz)	GPS & Galileo GPS & GLONASS GPS & BeiDou
3	100 ms	1 ms - 199 ms = 100 ms (10 Hz) 200 ms - 299 ms = 200 ms (5 Hz)	GPS, GLONASS & Galileo GPS, GLONASS & BeiDou (no correction services)

# of Constellations Configured	Sample Period	Example Effective Packet 60 Rate	Supported Constellation Configurations
4	125 ms	1 ms - 249 ms = 125 ms (8 Hz) 250 ms - 374 ms = 250 ms (4 Hz)	GPS, Galileo, GLONASS & BeiDou

Table 30: Aries Supported GNSS Constellation Configurations

Trimble BD992 GNSS Receiver

When using a Trimble BD992 GNSS receiver, the following configuration rules are applicable:

- For any given constellation, the first (1) frequency must be enabled in order to receive additional frequencies
- Galileo and BeiDou are licensed separately, see [5.4 GNSS Receiver License Upgrades](#) for details.
- L Band corrections are available on this receiver, however require an additional subscription to Omnistar or RTX. Advanced Navigation does not supply these, contact Trimble for further details.

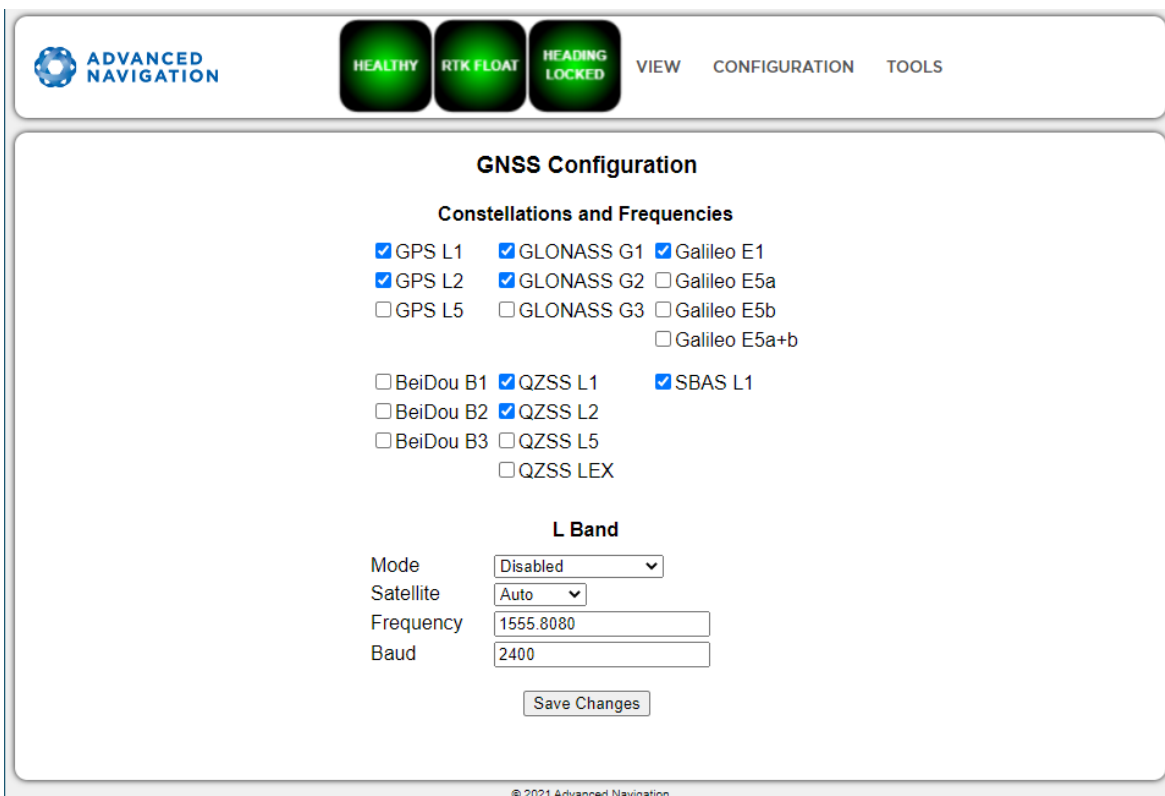

Figure 54: Certus Web UI BD992 GNSS Configuration Page

9.1.4 Tools Menu

The Tools menu contains tools for performing certain procedures with Certus.

9.1.4.1 Firmware Update

This page is used to update the Certus device firmware, Certus contains firmware which is regularly updated to improve performance and add features. Advanced Navigation recommends that you upgrade to the latest version whenever available. The firmware update function is robust, such that power loss, file corruption or other issues cannot cause problems with units. Check the [Certus](#) product page of the Advanced Navigation website periodically for updates.

Note: Advanced Navigation device firmware files have the extension .anfw.

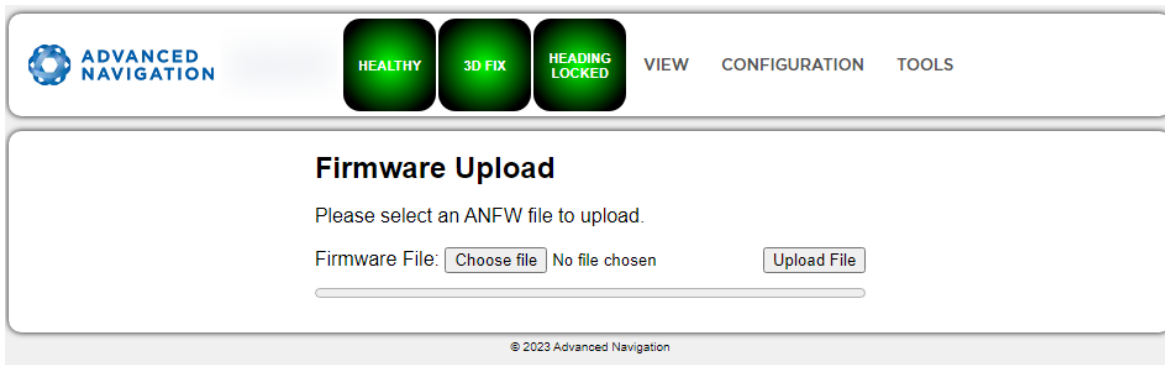

Figure 55: Web UI Firmware Update Page

Click "Choose File" and select the appropriate ANFW file for upload.

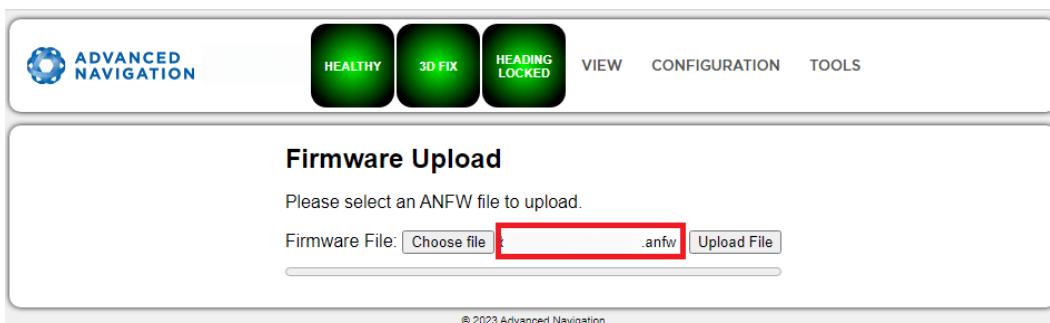

Figure 56: Firmware Update Choose File

Wait while the system uploads the firmware.

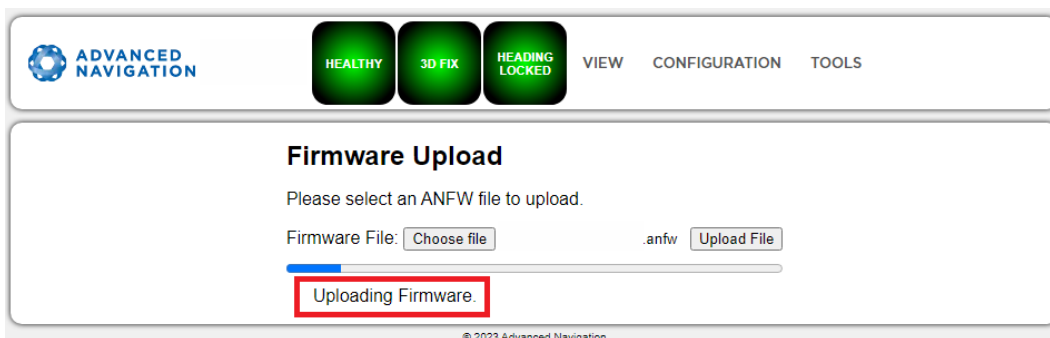

Figure 57: Firmware Update Uploading Firmware

Once uploaded, the system will automatically verify the firmware prior to reboot.

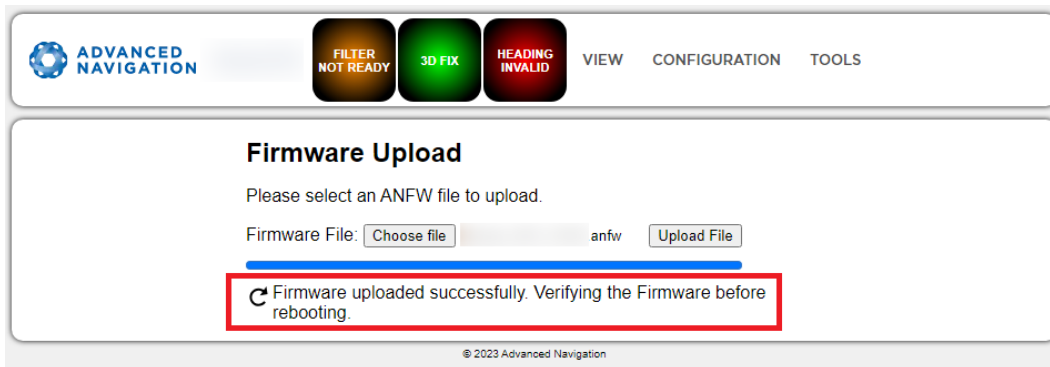

Figure 58: Firmware Update Verifying

Upon successful verification, a dialog box will appear indicating the device is rebooting to apply the update.

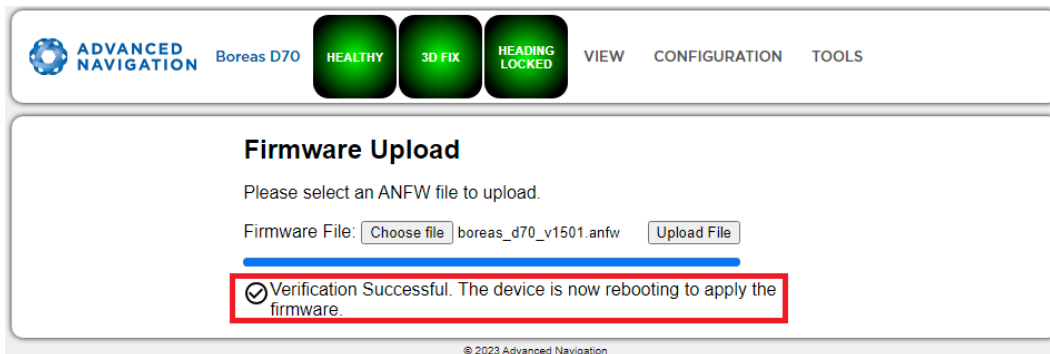

Figure 59: Firmware Update Complete

9.1.4.2 Logs

Certus features an onboard high capacity data logging system. Logging is enabled by default, but by default no specific data is configured to be logged. To enable logging of specific data packets or messages, see the Logging section on the [9.1.3.3 Data Ports](#) page (in the [9.1.3 Configuration Menu](#)).

If any log files exist on the Certus they will appear on this page in a list, with the most recent at the top. The log file name includes the date and time the log file recording commenced, using UTC time, in the format CertusLog_YY-MM-DD_HH-MM-SS.XXX. The log file extension identifies the file type.

If the time and date in the log file name is incorrect, this usually indicates that Certus does not have a GNSS fix and has therefore not yet determined the correct time.

Note that the logging configuration and recorded log files can only be accessed by the web UI. You cannot use the serial port interfaces.

Enabling and Disabling Logging

To enable or disable the logging functionality, select or deselect the Enable Logging check box and click Save Changes.

The log file currently being recorded is highlighted in green.

If recording an ANPP-format log file, the log file will include the current Certus device configuration.

Limiting the Maximum Log File Size

If you wish to limit the maximum file size for individual log files, select the Enable Splitting check box, enter a Max Log Size (in MiB), and then click the Save Changes button. This will not affect pre-existing log files but will affect the currently recording log file. Note this will round down to an integer if you enter a number with decimal places.

Downloading Log Files

You can download individual log files by simply clicking on them. Note, only one log file can be downloaded at a time using this method.

To download multiple log files, first select the files required, and then click the Download Selected button. This will download all the files to your computer and compress them into one ZIP file. Note, it may appear that nothing is happening during this process, and it can take some time to complete.

You can select all log files using the Select All button, or individually select log files using the check box on the left of the log file name.

Deleting Log Files

You can delete log files by selecting the specific log file(s) using the check box to the left of the log file name, or using the Select All button, and then click the Delete Selected button.

For bulk erasing ALL log files you can use the Format button. This will erase all log files irrecoverably. Note, it can take some time.

Starting New Log Files

The Start New Log button will stop writing the current log file and commence writing a new file. This new file will also include the current Certus device configuration. If logging is currently not enabled, this button will not do anything.

9.1.4.3 Viewing Logged Data

The ANPP log files are binary data and are therefore not in a human-readable format. To convert the ANPP log files you can use the Log Converter function of Certus Manager, see section [9.2.8.5 Log Converter](#). This will create CSV and KML files for your analysis.

All the ANPP packets are described in detail in [11 Advanced Navigation Packet Protocol](#).

NMEA0183 log files are ASCII text and can be opened in any text editor.

9.2 Using Certus Manager

Certus Manager is a software tool provided by Advanced Navigation for logging, testing, display and configuration of Certus. It is designed to be simple and easy to use. It should run on most Windows, MacOS and Linux computers.

Note: Java 11 is required to run Certus Manager. Adoptium JRE 11 is the recommended Java installer to be used on all platforms. Install the latest version of Java 11 from [Adoptium](#), selecting the correct operating system and architecture for your computer.

Certus Manager contains almost identical functionality to the web UI. This section will only include the areas that are different or absent from the web UI. Refer to the documentation for [9.1 Using the Web User Interface](#) as required.

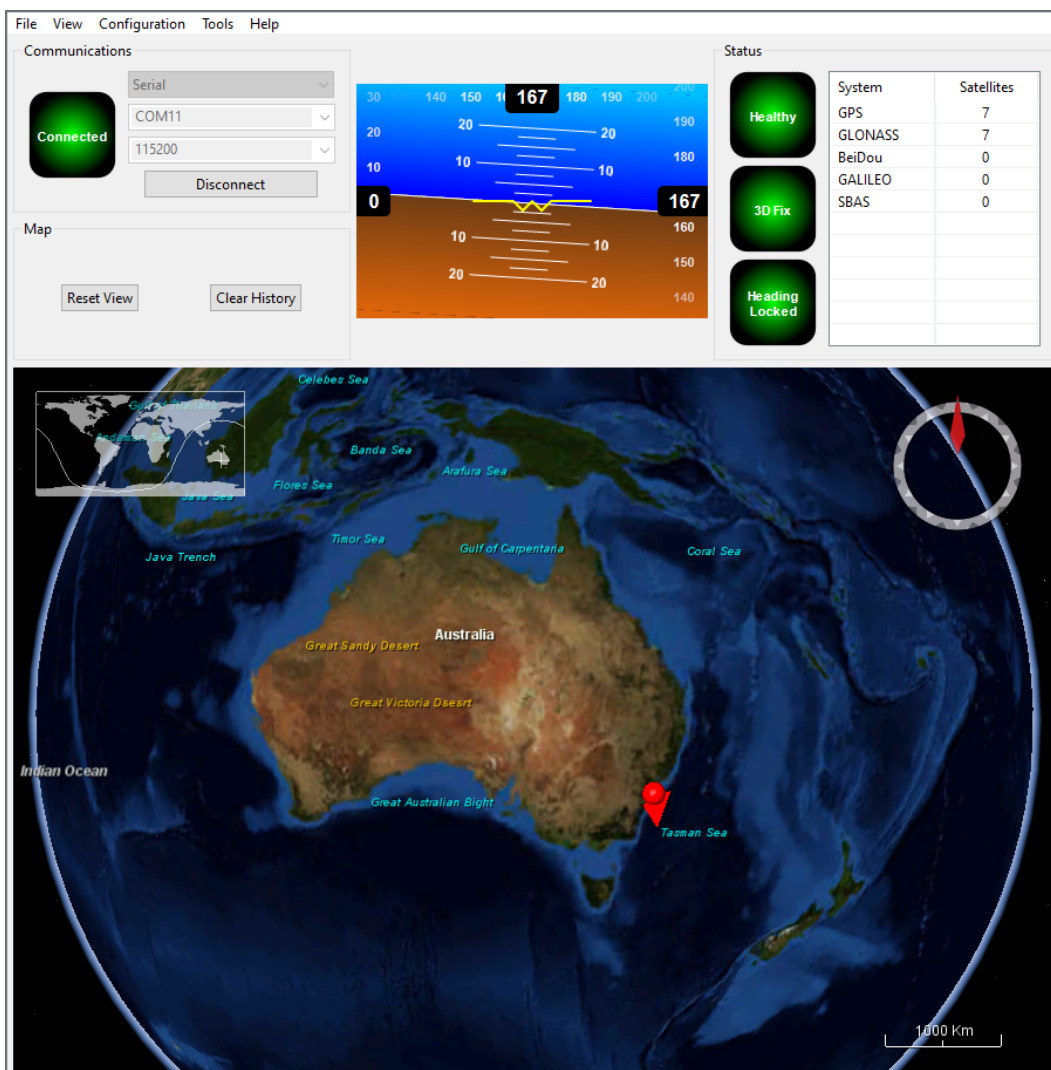

Figure 60: Screenshot of Certus Manager

9.2.1 Certus Manager Software Changelog

Version	Date	Changes
7.2	10 Nov 2023	<ul style="list-style-type: none"> Clear map history on reconnection Fix incorrect timezone text displayed in terminal.csv Updated leap-seconds list URL Add automatically log configuration at the start of a new log Added support for NavIC satellite system Fixed indicators behaviour on disconnect Updated support for Mac silicon with latest macOS Added support for extra NMEA 0183 messages Removed GNSS status indicator Fixed issue with opening windows containing charts Increased NTRIP client timeout Update support for Trimble BD9xx RTX frequencies as of 30 Sep 2022 Show COCOM status of Trimble BD9xx receivers in the licence field In satellites window, only populate azimuth and elevation fields in the table view when the values have been determined Added elevation to the gimbal state packet Add ability to set Packet Timer period
7.0	13 February 2023	<ul style="list-style-type: none"> Updated from JDK8 to JDK11. JRE11/JDK11 required to run this release Refresh Port Mode information on reconnection Refresh Packet Rates information on reconnection Fixed Ethernet Settings Static IP setting Improved reliability of firmware update Changed Low Voltage label to Internal Data Logging Error to support newer firmware Fixed issue with NTRIP client streaming from some servers When the NTRIP sourcetable says authentication type is any of ", 'B', 'N', then use Basic Authentication. This is to workaround NTRIP servers that incorrectly populate the authentication field Overwrite/clear existing packet rates on import of configuration Added Disable Dual Antenna Heading option Updated Seastar frequencies for Trimble receivers Updated RTX frequencies for Trimble receivers Added support for ARM (aarch64) processors with 64-bit OS Added support for Apple M1 processors and improved MacOS support Various UI improvements
6.2	10 October 2022	<ul style="list-style-type: none"> Added Moving Base output to GPIO configuration Fixed Packet Rates not being refreshed after a save Removed unavailable GPIO options Fixed status indicator message in case of a logging error Fixed configuration import via network Added allow firmware update over ANPP using Auxiliary, GPIO and Ethernet ports Added GNSS Firmware Update for BD992 variants Added CAN settings configuration Added ANPP14 Subcomponent information to Log Converter Added support for NTRIP Casters that request Username & Password to

Version	Date	Changes
		<p>retrieve source table</p> <p>Added copying version numbers etc from Device Information and GNSS Receiver Information dialog boxes</p> <p>Renamed Log Conversion menu item</p> <p>Added Settings menu item</p> <p>BaseStation.csv output "Fix Type" column now split into "Base Fix Type" and "Rover Fix Type"</p> <p>Added GPIO voltage selection</p> <p>Removed of SBAS corrections option when SBAS is not supported on the device</p> <p>Various bug fixes</p>
6.1	18 February 2022	<p>Improved NTRIP mountpoint selection</p> <p>Added handling of non-standard NTRIP server responses</p> <p>Changed "Low Voltage" Status Flag to "Internal Data Logging Error"</p> <p>Added EMSAT, OCSAT, IOSAT, etc and corresponding default frequencies to the Omnistar GNSS Configuration list</p> <p>Added ability to set custom L Band satellite frequency and baud</p> <p>GNSS receiver information is updated after applying a receiver option</p> <p>Updated source of map tiles</p> <p>Improved NTRIP server reconnection</p> <p>Improved export configuration reliability</p> <p>Added Device Discovery tool to find Advanced Navigation devices on the network</p> <p>Improve display of Trimble receiver options</p> <p>Added the ability to configure the Manager logging folder</p>
5.9	28 June 2021	<p>Add ability to disable logging</p> <p>Add ability to control log file location</p> <p>Add GNSS configuration page, support BD992 and Aries auto detect</p> <p>Log Converter now writes program version/name to output file</p> <p>Extract Magnetometers Enabled and Automatic Magnetic Calibration Enabled to Configuration.txt</p> <p>Add sensor temperatures packet to log converter</p> <p>Reset running time display upon connection</p> <p>Support new style GPIO output packet</p> <p>Fix GPIO output configuration window not working</p> <p>Fix NTRIP NMEA Message Output at Irregular Periods</p> <p>Various bug fixes</p>
5.7	23 September 2020	<p>Added support for Certus Evo Configuration Export and Import</p>
5.6	9 September 2020	<p>Updated raw sensors dialogue to include all temperatures</p> <p>Fixed bug with communications statistics dialogue cutting off numbers</p> <p>Added zero angular velocity update GPIO function</p> <p>Added Mavlink output GPIO function</p>
5.3	30 June 2020	<p>Add support for serial firmware update via Certus application for ANFW >2MB</p> <p>Fix bug in Extended Satellites display where it could show stale data.</p> <p>Add ability to set port modes (eg RS232 / RS422)</p>
5.2	20 May 2020	<p>Initial Release</p>

Table 31: Certus Manager Software Changelog

9.2.2 System Requirements

Certus Manager is only available for systems with x64 and ARM architectures.

Certus Manager includes a 3D mapping display which requires an internet connection. If your machine does not meet the graphics requirements the mapping view will only show space without a globe.

Note, when Certus is running at very high output rates e.g. 1000 Hz, Certus Manager can consume significant system resources handling such large quantity of data.

9.2.3 Installation and Starting

The latest version of Certus Manager can be downloaded from the [Certus](#) product page of the Advanced Navigation website. Installation notes are as follows:

- **Java 11 is required** to run Certus Manager.
Adoptium JRE 11 is the recommended Java installer to be used on all platforms. Install the latest version of Java 11 from [Adoptium](#), selecting the correct operating system and architecture for your computer.
- No installation process required for the Certus Manager application on a Windows system — it can be run from any directory by simply double clicking on it. To open the program on some systems it may be necessary to right click and select open with → Java Runtime Environment.
- On MacOS systems it may be necessary to run the application from a terminal window:

```
java -jar -XstartOnFirstThread CertusManager.jar
```
- On Linux systems it may be necessary to run the application from a terminal window:

```
java -jar CertusManager.jar
```

The Certus Evaluation Kit includes an FTDI USB to RS232 / RS422 adaptor cable. The drivers are normally installed automatically, but if not they are available for download from www.ftdichip.com/Drivers/VCP.htm.

9.2.4 Troubleshooting

If the application will not start, the most common reason is that you have 32-bit Java installed on a 64-bit operating system. Uninstall Java and reinstall the 64-bit version.

If the globe does not appear in the 3D map area, this indicates that either your graphics card is not powerful enough, your graphics card driver is out of date, or you have no internet connection.

- Ensure the RS232 / RS422 switch is in the correct mode. The Certus factory default mode is RS232.
- Ensure you select the correct COM port. This can be easily identified by unplugging and re-plugging in the USB connector.
- Ensure you have the correct baud rate selected in Certus Manager. The factory default value for the baud rate is 115200 bps for the Primary, GPIO and Auxiliary ports.

Contact technical support support@advancednavigation.com if you have any questions or require further assistance.

9.2.4.1 Windows

There is a well known problem with USB serial devices under Windows known as “crazy mouse”. The problem occurs when the system mistakenly installs the USB serial device as a mouse. If you experience this problem, often a restart will resolve it. Otherwise there is a tool that can fix this issue available at <http://www.stentec.com/anonftp/pub/wingps/pnpblockersetup.exe>.

If the serial port does not show up when you plug in the FTDI USB to RS232/RS422 adaptor cable, you may need to install the drivers from www.ftdichip.com/Drivers/VCP.htm.

When operating Certus on Windows at a high data rate, data can be lost due to the latency of the FTDI driver. To resolve this problem the latency of the driver should be reduced to 1 ms:

1. Start the Windows Device Manager (1) and find the Ports section (2).
2. Identify the specific COM port being used (3) by dis-connecting and re-connecting the USB to RS232 / RS422 adaptor cable.
3. Right click on the identified COM port and select Properties. Select the Port Settings tab (4) and select Advanced (5).
4. Change the Latency Timer value (6) to 1 msec then press OK (7), and OK again for the previous window.

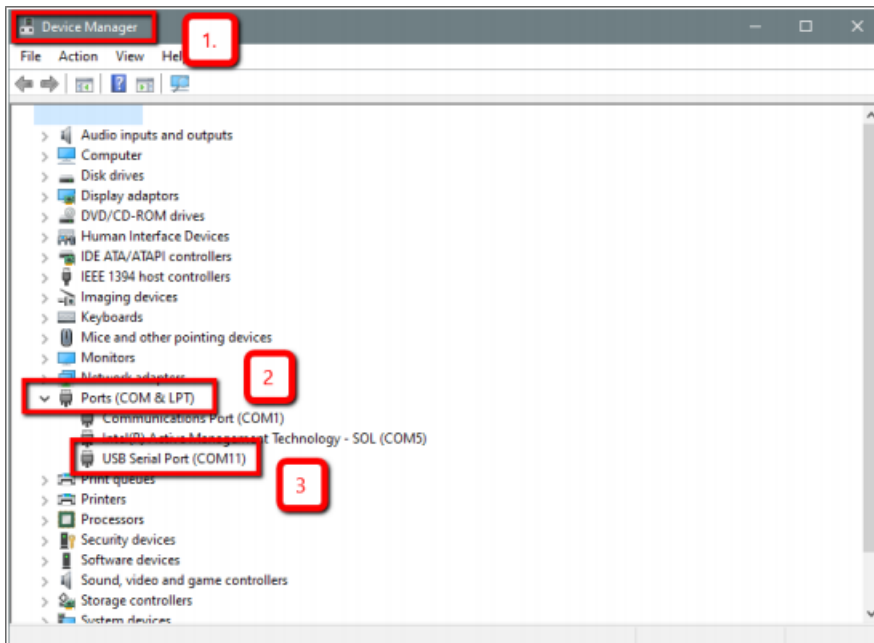

Figure 61: Setting the Windows Port Latency Value - 1

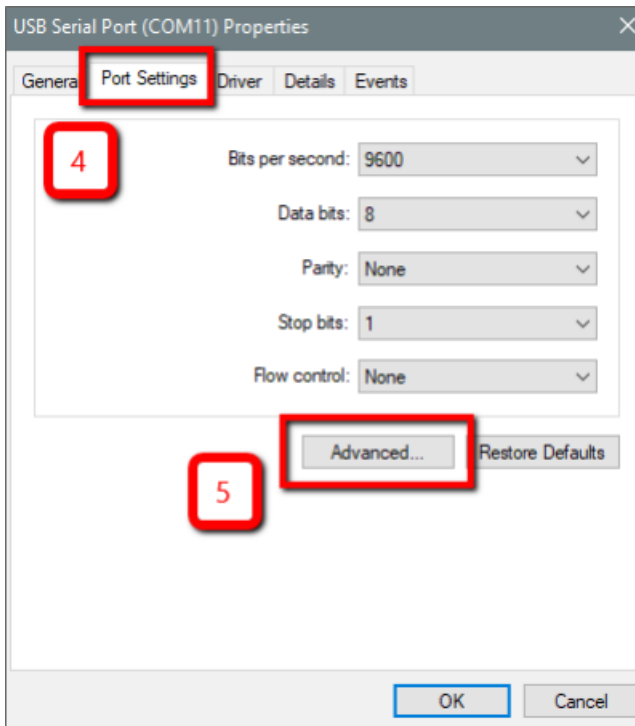

Figure 62: Setting the Windows Port Latency Value - 2

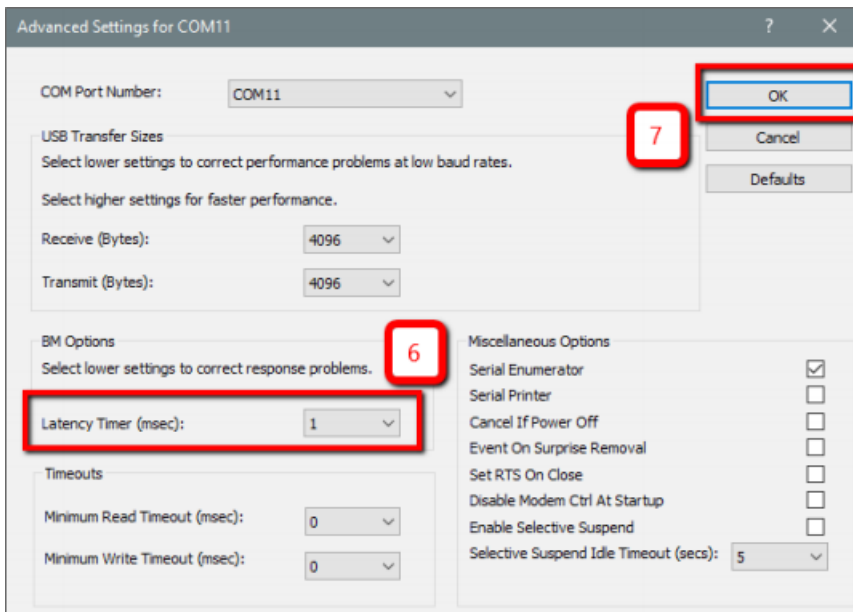

Figure 63: Setting the Windows Port Latency Value - 3

9.2.4.2 Linux

If serial ports do not show up, the typical reason is a lack of permissions. The user should add themselves to the dialout group with the command:

```
sudo adduser username dialout
```

Compiz causes issues with the 3D mapping. If you are experiencing problems it is recommended to turn off Compiz.

Modemmanager can also sometimes cause problems on Linux installations. If you are not using a modem, it is recommended to remove modemmanager with the command:

```
sudo apt-get remove modemmanager
```

9.2.5 Main View

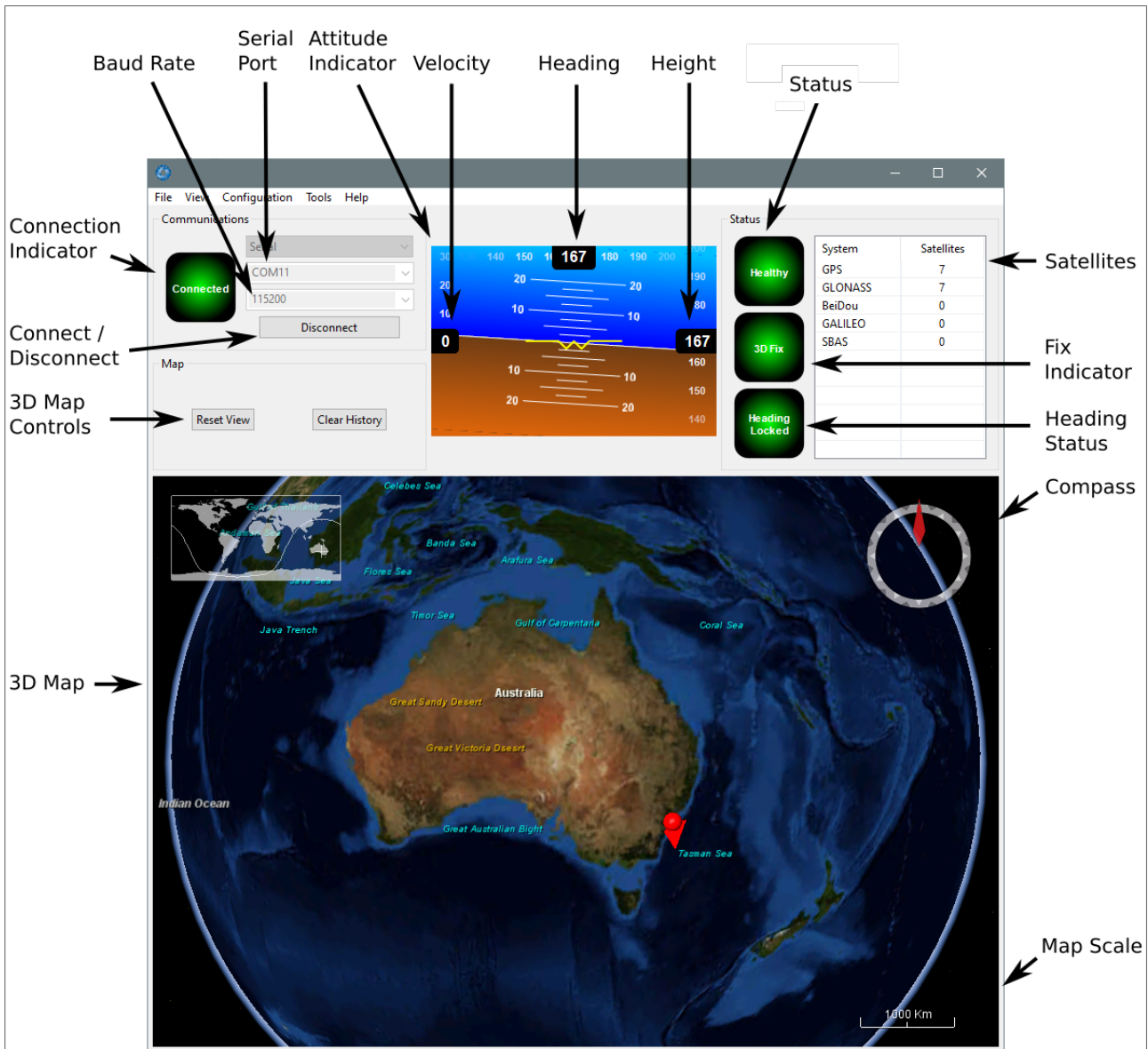

Figure 64: Manager Main View

9.2.5.1 Serial Port

The Serial Port dialogue is used to connect to Certus. Select the serial port and baud rate and click **Connect**. The Connection Indicator displays whether there is communication with a Certus unit.

9.2.5.2 Attitude Indicator

The aircraft style Attitude Indicator shows roll and pitch through a virtual horizon. Around the sides heading, speed and height are shown. All units are SI (metric) and degrees.

9.2.5.3 Satellites Table

The Satellites table shows the number of satellites visible by the primary antenna. More detailed information can be found in the [9.2.6.4 Satellites](#) sub section under the [9.2.6 View Menu](#).

9.2.5.4 Status Indicator

The Status indicator section contains a Certus status indicator, a fix indicator and a satellites table.

- Certus Status Indicator - This indicator shows any problems with Certus. Before a GNSS position fix is achieved it will show the status "Filter not initialised". Once the filter has initialised it should show "Healthy". Clicking on the indicator will show the detailed status flags.
- Fix Indicator - This shows the status of the GNSS position fix. Under normal operating conditions it should show either "3D Fix" or "SBAS Fix". When satellite visibility is poor it may show either "2D Fix" or "No Fix".
- Satellites Table - The Satellites table shows the number of active satellites being used in the current GNSS solution. More detailed information can be found in the satellites view.

9.2.5.5 3D Map

The 3D map shows the Certus position on the Earth as well as a red trail of position history. When the filter initialises the map will automatically reset the view to the Certus position. To move the camera click and drag on the map. To zoom in and out use the mouse scroll wheel. To change the camera view right click and drag or shift click and drag.

9.2.5.6 3D Map Controls

- Reset View : This resets the map view to current position.
- Clear History: This clears the current position history, this is the red trail shown on the map.

9.2.5.7 Baud Rate

This displays the current and available baud rates options for the serial connection.

9.2.5.8 Connect / Disconnect

This button enables the serial connection to be either connected or disconnected.

9.2.6 View Menu

9.2.6.1 View

The View menu contains a number of different options for viewing data from Certus.

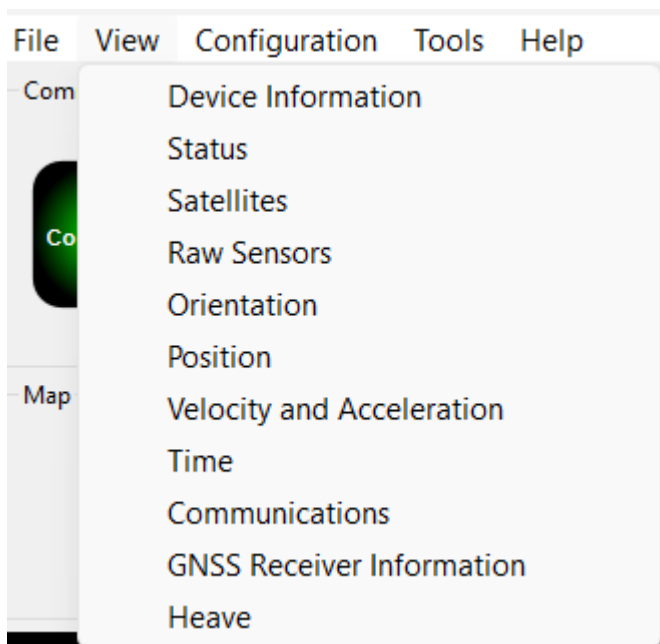

Figure 65: Manager View Menu

9.2.6.2 Device Information

Device information is useful during technical support and for tracking your serial number, firmware and hardware version.

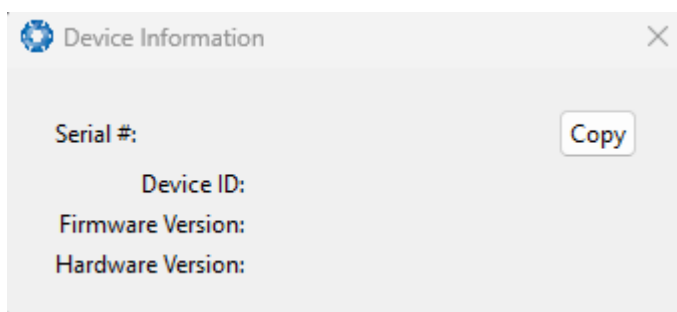

Figure 66: Manager Device Information

9.2.6.3 Status

The Status shows the current status of Certus as reported by sections [11.4.1 System State Packet](#) (ID#20) and [11.4.10 Raw GNSS Packet](#). (ID#29).

Note: The following Status flags do not update for Certus units with a Trimble BD992 GNSS Receiver. These flags are only applicable to Aries GNSS Receivers: GNSS 2, Antenna 1 disconnected, Antenna 2 disconnected, Antenna 1 short, Antenna 2 short

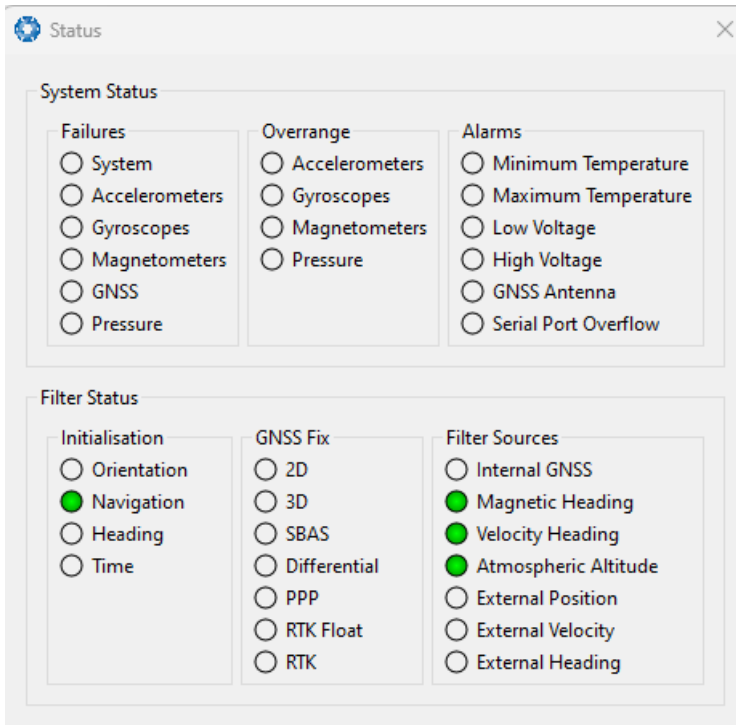

Figure 67: Manager Status Dialogue

9.2.6.4 Satellites

The Satellites dialogue shows detailed information on the satellites that are visible to the Certus GNSS receiver. The information is displayed as a satellite skyplot, a table and an SNR (Signal-to-Noise Ratio) graph. A maximum of 28 satellites will be displayed, even if more are accessible. This plot shows the SNR of each satellite at the primary and secondary antenna. As a guideline, these should be within 5-10 dB of each other in the absence of cable or antenna faults. Elevation and azimuth are in units of degrees.

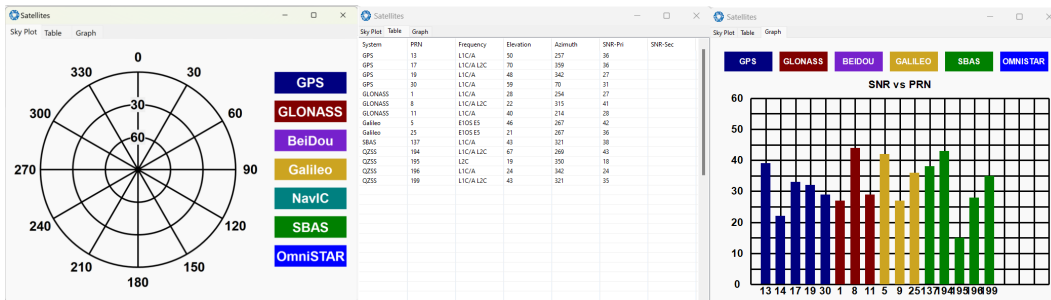

Figure 68: Manager Satellites Table

9.2.6.5 Raw Sensors

Raw sensors shows the temperature calibrated raw sensor values.

Temperature readings are available for a range of sensors: T(Ax), T(Ay), and T(Az) correspond to the accelerometer's x, y, and z axes; T(Gx), T(Gy), and T(Gz) relate to the gyroscope's X, Y, and Z axes; T(M) is for the magnetometer; and T(P) indicates pressure.

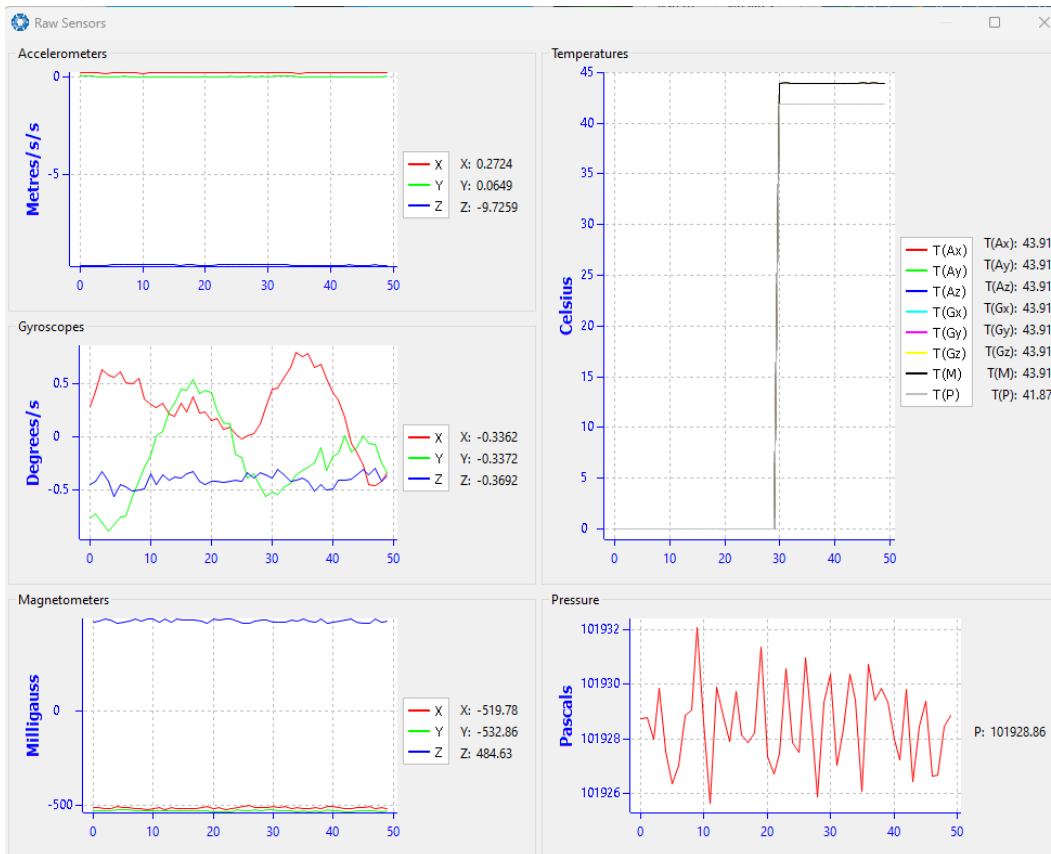

Figure 69: Manager Raw Sensor Outputs

9.2.6.6 Orientation

Orientation shows the Certus orientation, angular velocity and orientation error. To enhance the user's understanding of some of the less intuitive metrics, **Course** is defined as the path determined by measuring sequential positions, and **Slip** is the difference between the heading and the course.

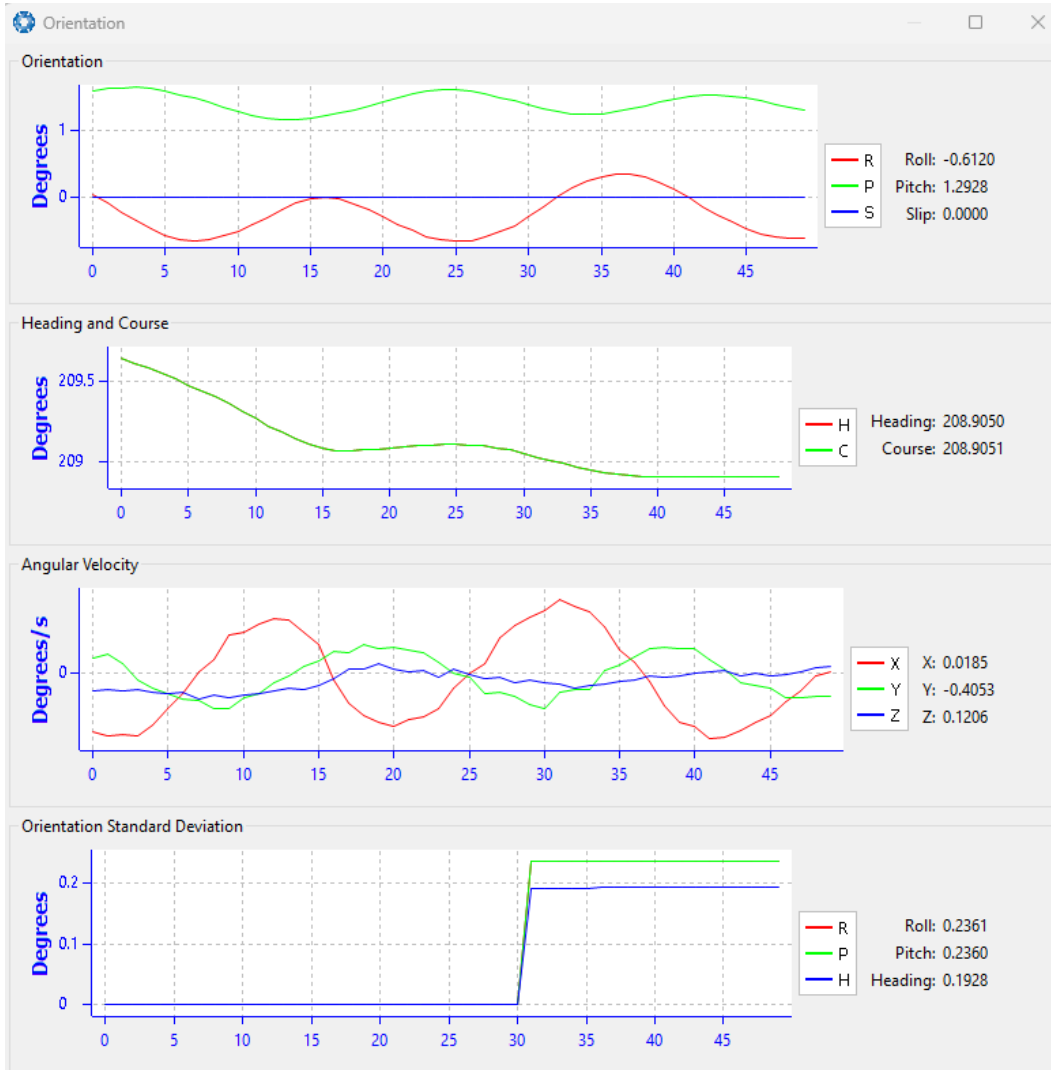

Figure 70: Manager Orientation Outputs

9.2.6.7 Position

Position shows the Certus position and position error. Latitude and longitude are converted to North and East metres from a reference point that can be reset.

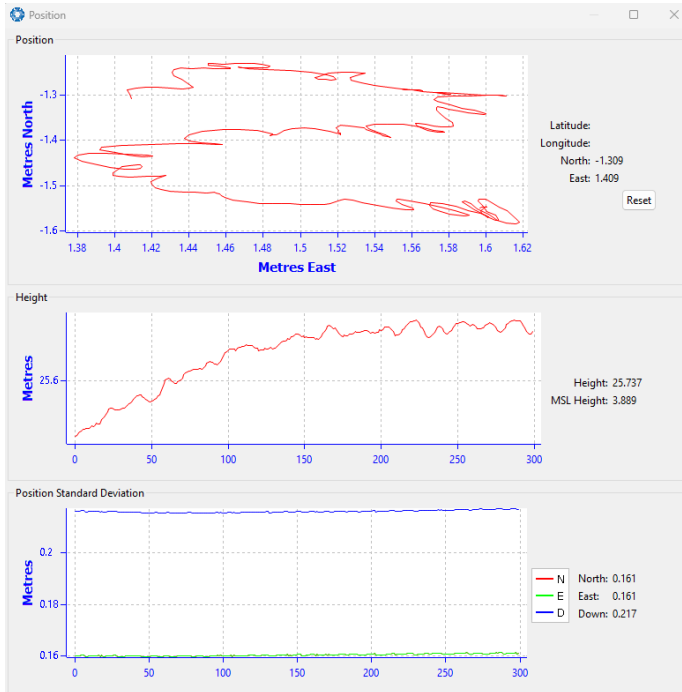

Figure 71: Manager Position Outputs

9.2.6.8 Velocity and Acceleration

Velocity and Acceleration shows the Certus velocity, acceleration and g-force.

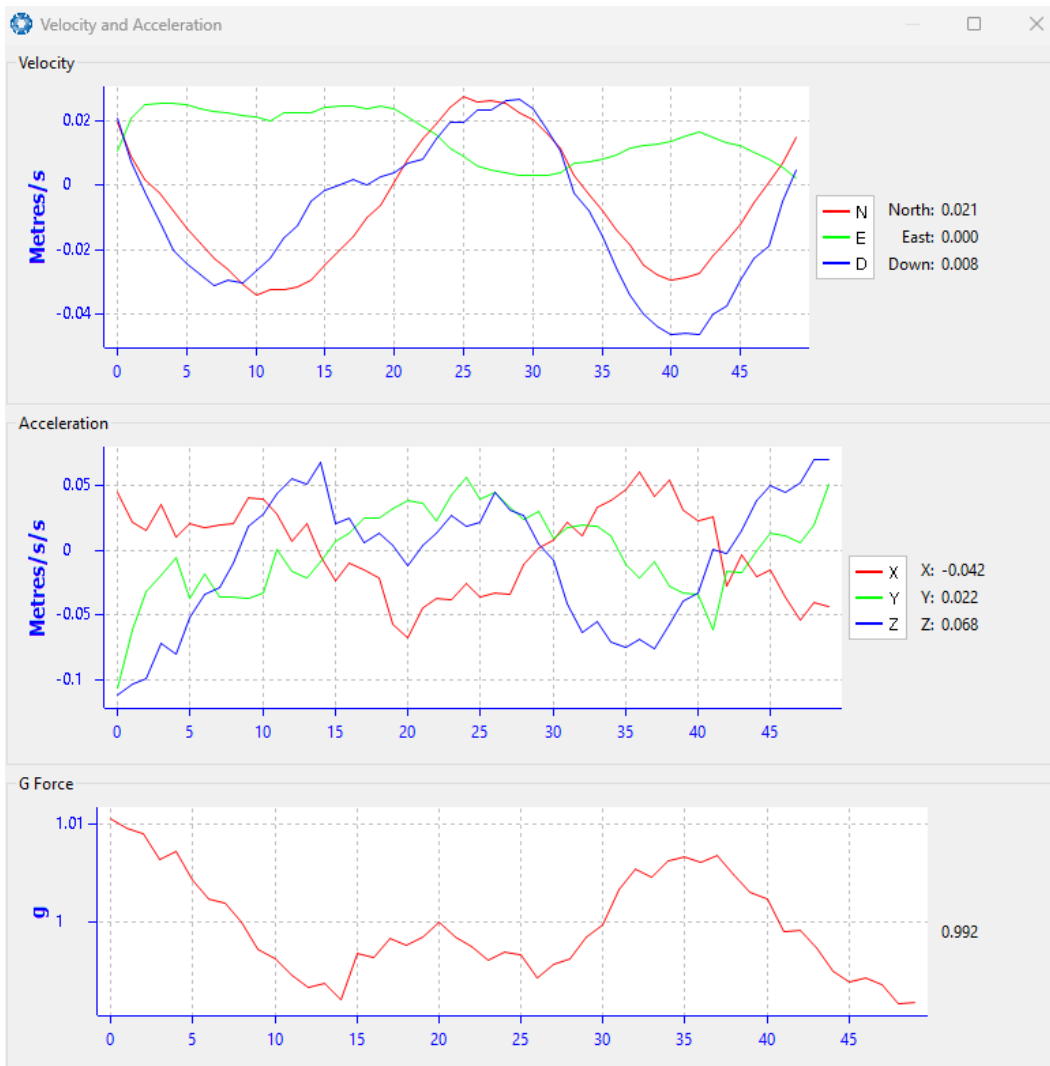

Figure 72: Manager Velocity and Acceleration Outputs

9.2.6.9 Time

This dialogue box allows the to view the time for the connected device. Views are in Unix, UTC, or Local time formats to best suit user requirements to ensure accurate timekeeping and synchronisation across systems.

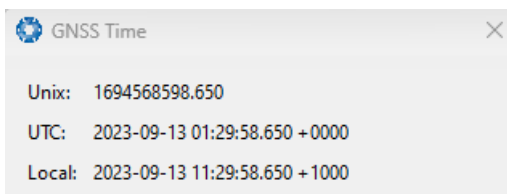

Figure 73: Time Dialogue

9.2.6.10 Communications

This dialogue shows statistics on the data packets received from Certus and can be useful in diagnosing signal integrity problems.

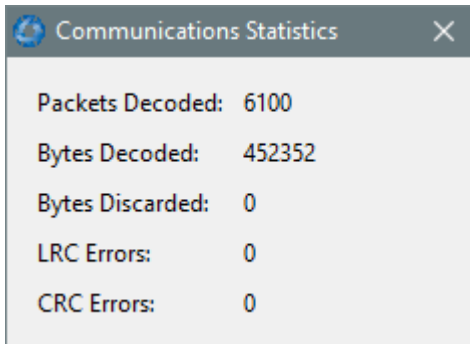

Figure 74: Manager Communications Dialogue

9.2.6.11 GNSS Receiver Information

This dialogue shows information about the GNSS receiver fitted to the Certus.

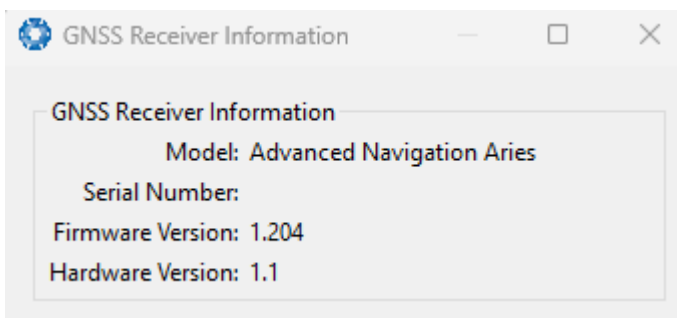

Figure 75: Manager GNSS Receiver Information Dialogue

9.2.6.12 Heave

For the Heave dialogue to function the heave packet (ID 58) must be set to output periodically using the Packet Rates dialogue.

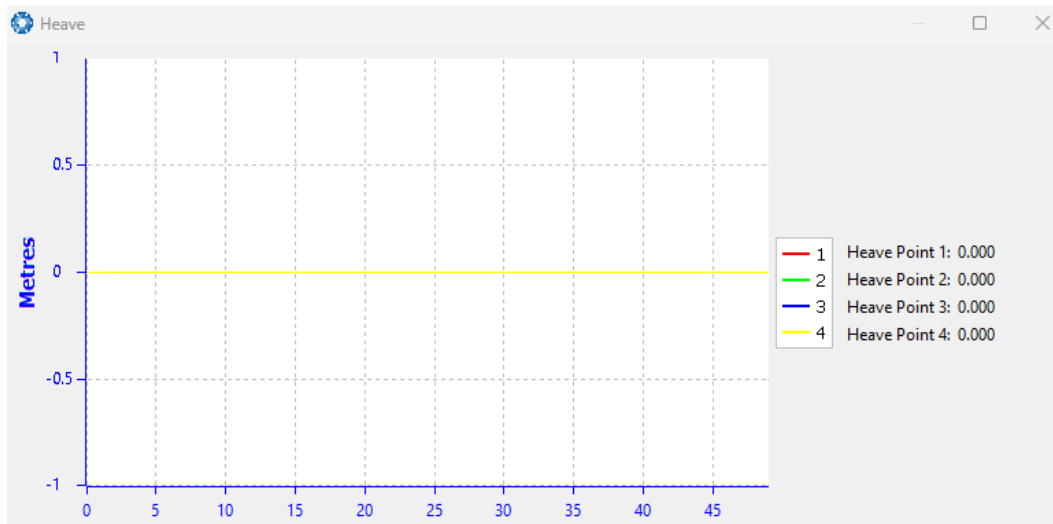

Figure 76: Manager Heave Outputs

9.2.7 Configuration Menu

The Configuration menu contains a number of dialogues for the configuration of Certus.

Figure 77:

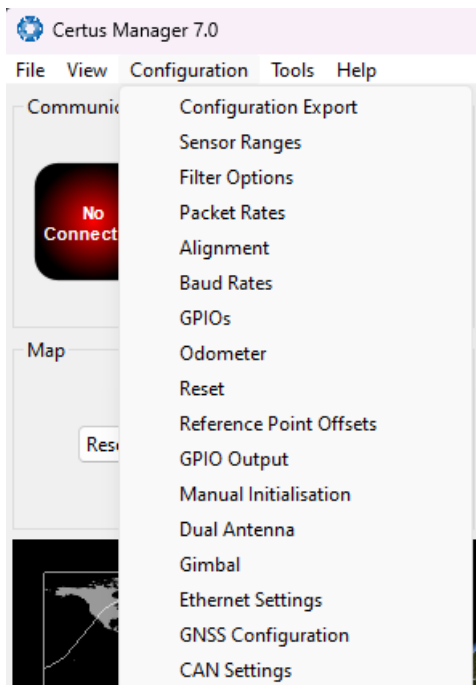

Figure 78: Manager Configuration Menu

9.2.7.1 Configuration Export

The Configuration Export dialogue can be used to export all the Certus settings to a file. This file can be imported at a later date or on other units. This is useful to restore a unit to a pre set configuration at a later date or for batch configuration of multiple units.

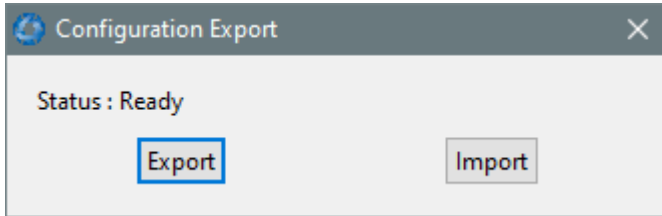

Figure 79: Manager Configuration Export Dialogue

9.2.7.2 Sensor Ranges

Note: The sensor range can only be modified for Certus. Certus Evo only offers a fixed sensor range. See [6.1 Navigation Specifications](#) for sensor range specifications.

The Sensor Ranges dialogue is used to set the dynamic range of the sensors. If the user is experiencing over-range events during operation, these settings should be used to increase the range of the sensor which is reporting the over-range. The lowest ranges give the best performance, the user should make changes slowly and monitor the results.

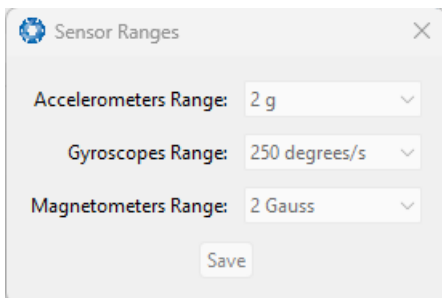

Figure 80: Manager Sensor Ranges Dialogue

9.2.7.3 Filter Options

For most applications the default filter options should be used and only the vehicle profile set. If in doubt please contact support@advancednavigation.com.

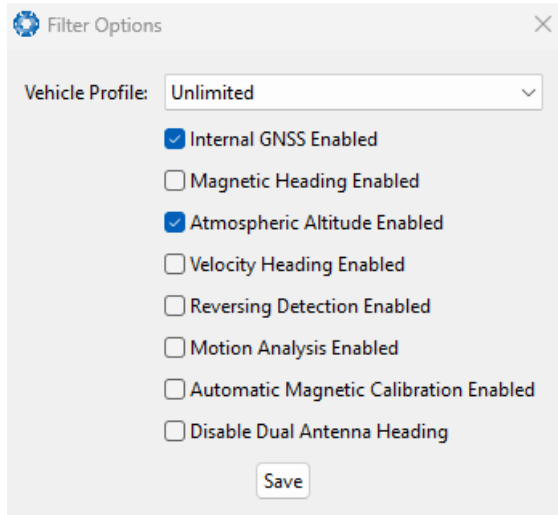

Figure 81: Manager Filter Options

9.2.7.4 Packet Rates

The Packet Rates dialogue allows the user to specify which packets output on a periodic basis and at what rate. The default packets enabled are the System State Packet (ID 20) and the Raw Sensors Packet (ID 28) at 20Hz and these typically provide all the data that a user will require. These two packets need to be enabled for the data graphs to update in Certus Manager. Other state packets can be enabled as required.

Note: Packet rate configuration applies only to the data port which the Manager is connected to. To configure other ports, the Manager must be connected to that port.

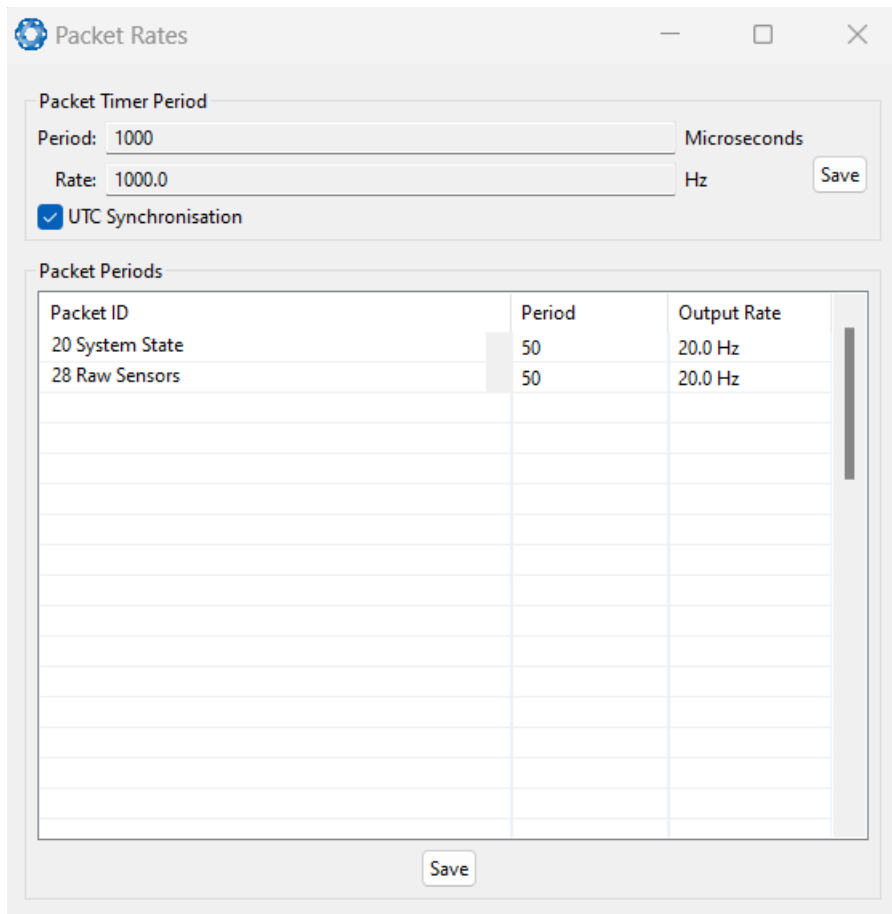

Figure 82: Manager Packet rates

9.2.7.5 Alignment

The Alignment dialogue is used to set the alignment offsets of the system installation. It is important to set the values in this dialogue correctly for accurate results. For most applications only the GNSS antenna offset values need to be entered and the rest of the values can be left at their factory defaults of zero.

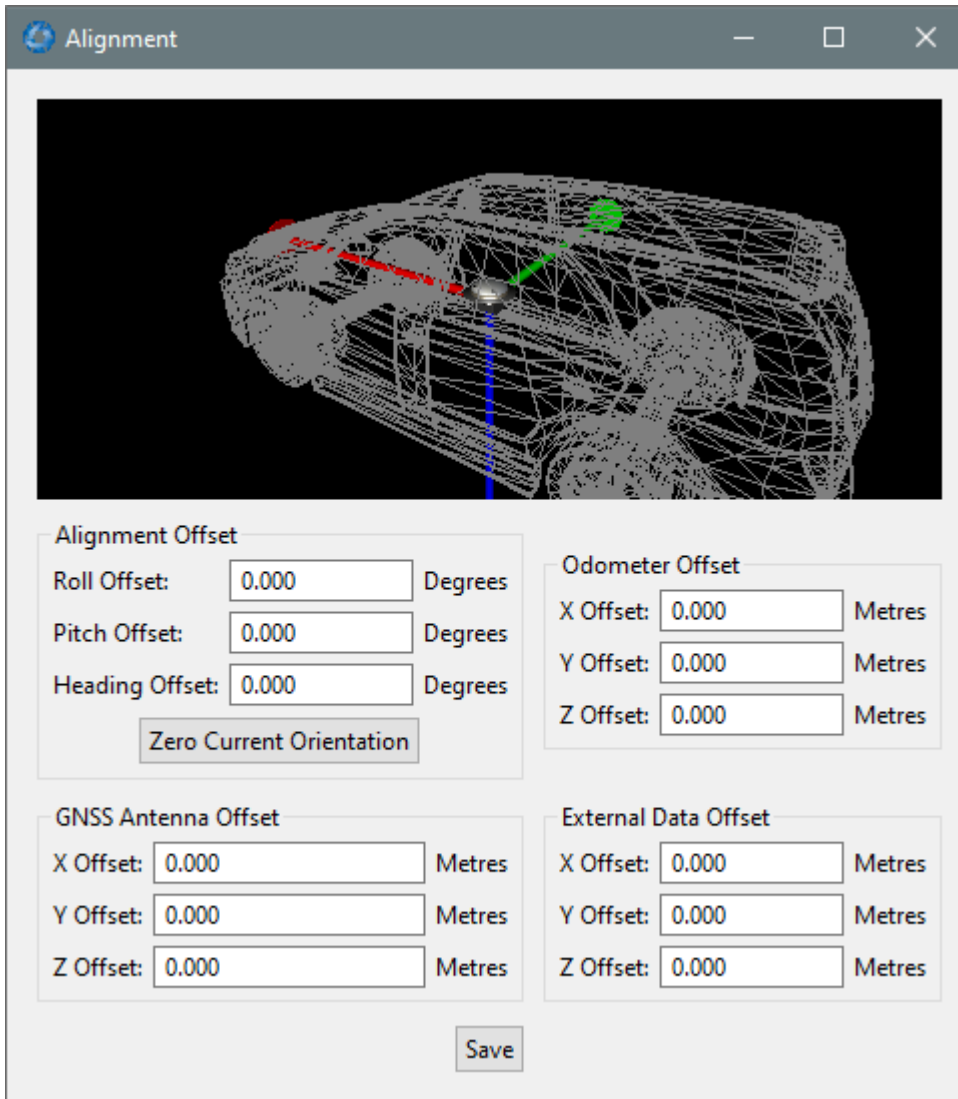

Figure 83: Manager Alignment Dialogue

Alignment Offset

If Certus is installed into the vehicle with the positive X-axis pointing forwards and the positive Z-axis pointing down, then no alignment offset is required and the roll, pitch and heading offset values can remain at the factory defaults of zero.

If the unit is installed in a different orientation then the roll, pitch and heading offset must be entered. For example if the unit is installed on its side with the X-axis pointing up and the Z-axis pointing forwards and no change to the Y-axis, then this would result in a pitch offset of +90 degrees with roll and heading remaining zero.

If there is a small misalignment due to mechanical mounting error this can be compensated for by setting the vehicle stationary on a level surface and pressing the **Zero Current Orientation** button.

Note: Zero Current Orientation will only correct for roll and pitch offsets, the Heading offset must be entered manually and saved before using this function.

All the other offsets will be measured in the realigned body co-ordinate frame (X positive forward, Z positive down) after being corrected for any alignment offset entered.

GNSS Antenna Offset

The GNSS antenna offset is measured from the centre of the Certus unit to the phase centre of the primary antenna in the orientation of the [12.3 The Body Co-ordinate Frame](#) (X positive forward, Z positive down).

Odometer Offset

The odometer offset is measured from the centre of the Certus unit to the point at which the vehicle's tyre being measured makes contact with the road in the body co-ordinate frame (X positive forward, Z positive down).

If your odometer is not measuring a specific wheel, the offset should be to the point on the ground beneath the measurement point. If, for example, your car is a front wheel drive and you are using the velocity from the car OBDII port, the measurement point would be midway between the two front wheels.

External Data Offset

These values are only required for speciality applications operating with an external source of velocity data. The offsets are used when providing NMEA Input, External GNSS, or with an Air Data Unit. When using a DVL, use the odometer offset. Contact support@advancednavigation.com for assistance with these values.

9.2.7.6 Port Mode and Baud Rates

Some machines running Microsoft Windows do not support higher baud rates. When changing baud rates, it is recommended to test the baud rate configuration first, without ticking the Permanent box. This way, if it is not possible to communicate at the higher baud rate, a power cycle can be used to revert to the previous baud rate setting.

The factory default baud rate value for these ports is 115200 bps.

The primary and auxiliary ports can be set to RS232 or RS422. The factory default is RS232 for both ports.

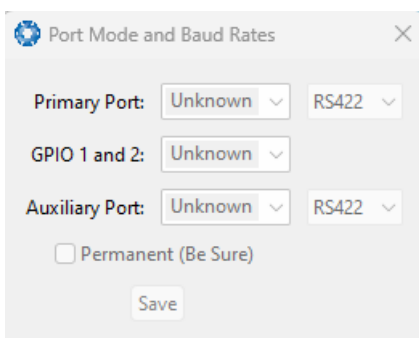

Figure 84: Manager Baud Rates Dialogue

9.2.7.7 GPIO

This page allows the user to configure the input and output functions of the GPIO and Auxiliary ports. These functions are described in detail in [10.6.1 Dynamic Pin Functions](#). These functions change dynamically and are effective immediately upon clicking **Save Changes**.

Note: The GPIO port functions at RS232 levels for data functions and 0 to 5 volt (or 0 to 3.3 V) levels for all other functions. The auxiliary port functions at RS232 or RS422 levels for data functions and 0 to 5 volt (or 0 to 3.3 V) levels for all other functions. The internal hardware automatically reconfigures based upon the selected function.

The default values for these settings are Inactive. The dedicated 1PPS signal is active by default.

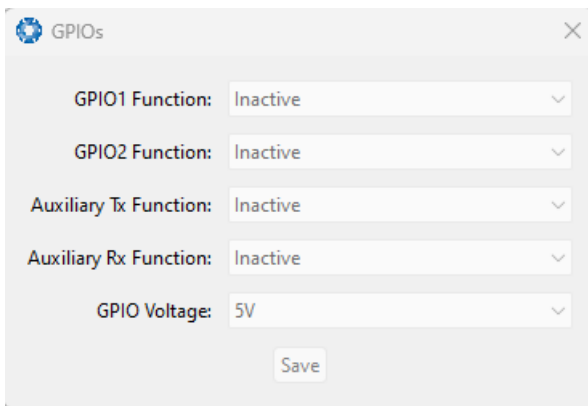

Figure 85: Manager GPIO configuration Dialogue

9.2.7.8 Odometer

The Odometer dialogue allows the user to configure the odometer pulse length and view the real time odometer data to verify correct operation. See [7.7 Odometer](#) and [8.10 Odometer Pulse Length](#) for more information on the use of odometers. The odometer offset is also applied when using a DVL input.

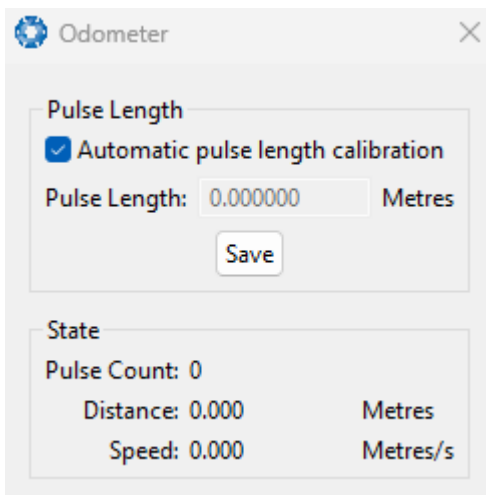

Figure 86: Manager Odometer Dialogue

9.2.7.9 Reset

The Reset button causes the system to perform a power cycle. No configuration settings or state data are lost. The Cold Start button clears all filters, and connections are reset and must re-established. No configuration settings are lost. The Factory Restore button resets all Certus settings back to their factory defaults, including state data and all configuration settings. It also erases the hot start data so that the system is forced to perform a cold start.

Note: A Factory Restore will re-enable the DHCP Client and lose any static IP address settings.

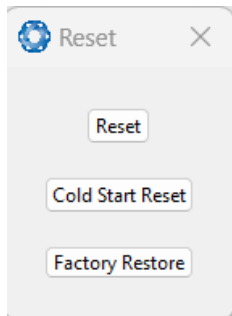

Figure 87: Manager Reset Dialogue

9.2.7.10 Reference Position Offsets

The Reference Point Offsets dialogue allows the user to set measurement points away from its default position at the physical centre of the Certus unit. The primary reference point offset applies to data from all ANPP packets as well as all peripheral output such as NMEA messages and Heave Point 1.

When the values are zero the measurement point is the centre of the Certus unit. This can be offset to a different position on the profile by entering the offset value from the centre of the Certus unit to the desired position in the body co-ordinate frame (X positive forwards, Z positive down).

The Heave Points 2 to 4 allow the user to offset reference points for the heave values 2 to 4 in the [11.4.37 Heave Packet](#).

Note: These values only apply to the Heave Packet. NMEA, TSS and Simrad heave is not affected by the values in this dialogue which are always measured at the centre of the Certus unit.

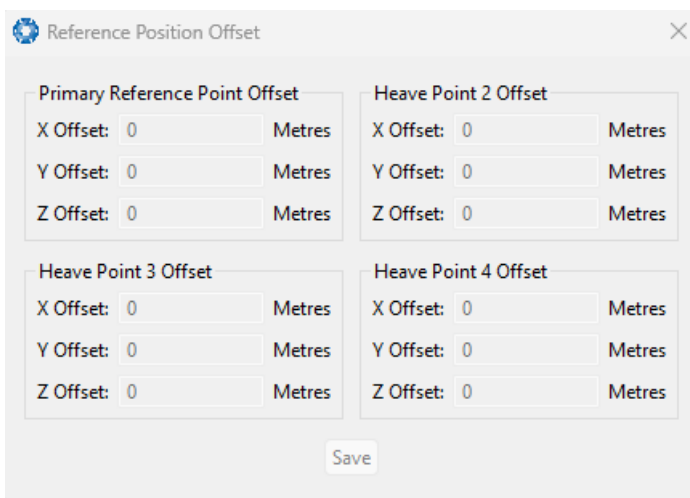

Figure 88: Manager Reference Position Offset

9.2.7.11 GPIO Output

The GPIO output configuration dialogue allows the user to configure the NMEA0183, TSS1 and SIMRAD output rates for the GPIO and Auxiliary port. These output rates will be observed with respect to the actual output selected in the [9.2.7.7 GPIO](#) port configuration.

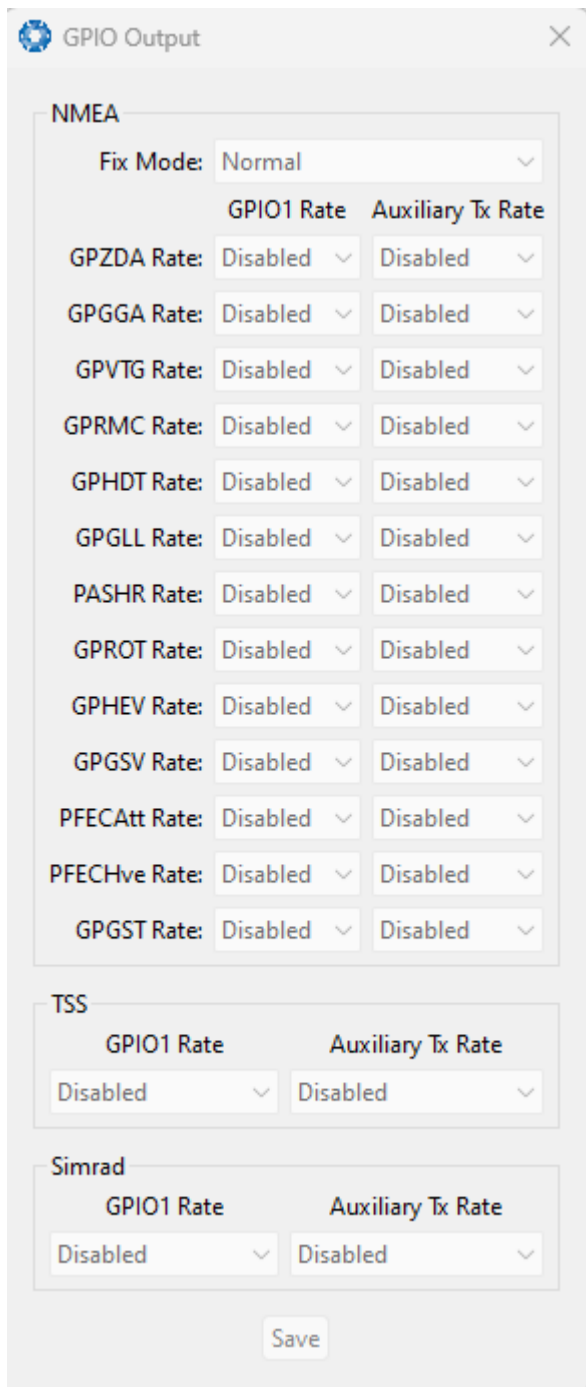

Figure 89: Manager GPIO Output Dialogue

9.2.7.12 Manual Initialisation

The Manual Initialisation dialogue can be used to manually initialise Certus when a GNSS fix is not available. Setting the position will initialise the navigation filter. Setting the heading will also initialise the heading filter.

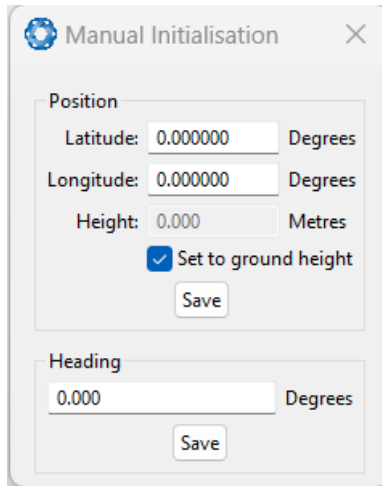

Figure 90: Manual Initialisation Dialogue

9.2.7.13 Dual Antenna

The Dual Antenna configuration page is only used if the primary and secondary GNSS antennas are not installed in their recommended and default positions of primary front and secondary rear, at the same height. If it is not practical to mount the antennas in the recommended alignment, the alternate alignments must be entered into this page. It is recommended to try and use one of the automatic offsets where possible, where the antennas must be installed in one of four different automatic offset orientations aligned on an axis. If it is not possible to use one of the automatic offsets, the antennas can be installed in any configuration and a manual offset should be entered. The manual offset is measured from the central base of the secondary antenna to the central base of the primary antenna in the body co-ordinate frame (X+ forward, Z+ down). If using a manual offset, be careful to measure the offset accurately, as even small offset errors can result in relatively large heading errors e.g. 2 cm error = 1.15 degrees heading error with a 1 metre separation.

- When using an automatic offset, the manual offset values are ignored.
- When using a manual offset, the automatic offset selection is ignored.
- When using automatic offset, the manual offset values will show the distance that Certus has automatically measured.

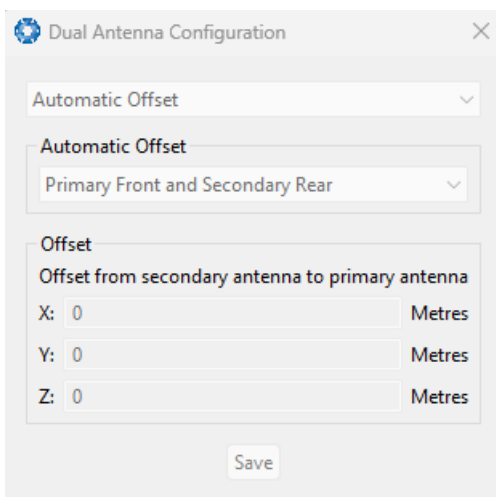

Figure 91: Manager Dual Antenna Dialogue

9.2.7.14 Gimbal

The Gimbal configuration dialogue is only used in speciality gimbal applications. Contact support@advancednavigation.com for more information on using Certus inside a gimbal.

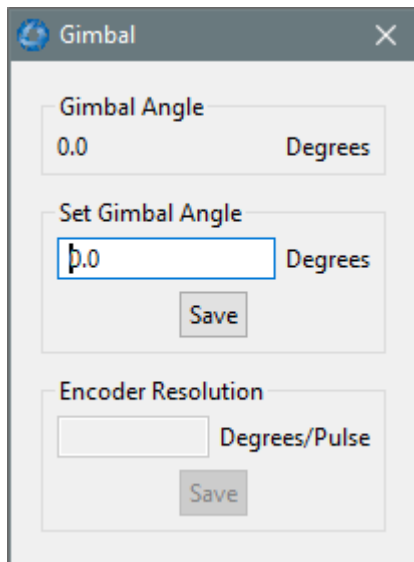

Figure 92: Manager Gimbal Dialogue

9.2.7.15 Ethernet Settings

The Ethernet Settings dialogue allows the user to enable or disable the DHCP Client. When the DHCP Client is disabled you need to enter the TCP/IP settings if the user wishes to access the web UI. If the user is connecting to Certus via the primary port these settings can be ignored. The default is for the Ethernet mode to be set to DHCP.

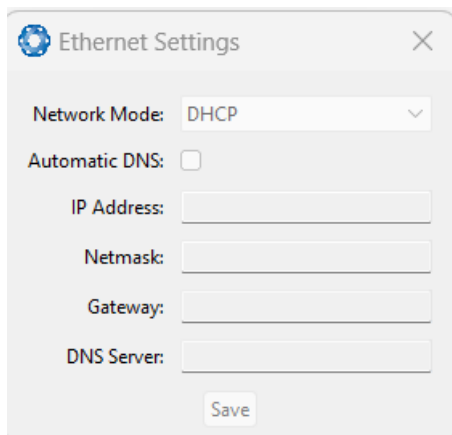

Figure 93: Manager Ethernet Settings Dialogue

9.2.7.16 GNSS Configuration

The GNSS Configuration dialogue allows the user to select constellation configurations based on the type of GNSS receiver installed. If an invalid configuration is entered, the system will revert to the previous configuration when attempting to save changes. To confirm that changes have been successfully saved, close and re-open the GNSS Configuration dialogue.

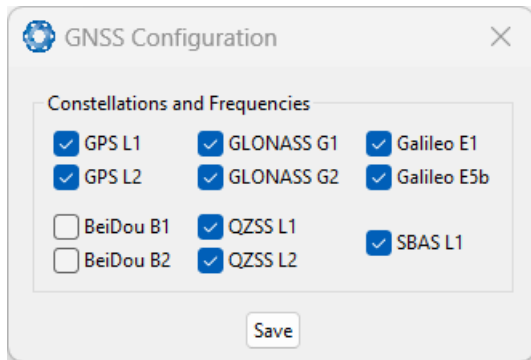

Figure 94: Manager GNSS Configuration Dialogue

Aries GNSS Receiver

When using an Aries GNSS receiver, the following configuration rules are applicable:

- By default, GPS, Galileo and GLONASS are enabled, along with SBAS and QZSS correction services.
- When selecting a GNSS constellation, all frequencies for that constellation must be selected.
- SBAS and QZSS correction services can also be enabled for all constellation configurations, except when using GPS, Galileo and BeiDou together.

The table below lists the supported constellations and the corresponding GNSS sample period depending upon the number of constellations selected. When setting the data ports, the packet rate of the [11.4.10 Raw GNSS Packet](#) and [11.4.38 Raw Satellite Data Packet](#) are automatically adjusted to the next lower integer multiple of the sample period.

# of Constellations Configured	Sample Period	Example Effective Packet 60 Rate	Supported Constellation Configurations
1	50 ms	1 ms - 99 ms = 50 ms (20 Hz) 100 ms - 149 ms = 100 ms (10 Hz) 150 ms - 199 ms = 150 ms (6.67 Hz)	GPS Galileo GLONASS BeiDou
2	80 ms	1 ms - 159 ms = 80 ms = 12.5 Hz 160 ms - 239 ms = 160 ms (6.25 Hz)	GPS & Galileo GPS & GLONASS GPS & BeiDou
3	100 ms	1 ms - 199 ms =	GPS, GLONASS &

# of Constellations Configured	Sample Period	Example Effective Packet 60 Rate	Supported Constellation Configurations
		100 ms (10 Hz) 200 ms - 299 ms = 200 ms (5 Hz)	Galileo GPS, GLONASS & BeiDou (no correction services)
4	125 ms	1 ms - 249 ms = 125 ms (8 Hz) 250 ms - 374 ms = 250 ms (4 Hz)	GPS, Galileo, GLONASS & BeiDou

Trimble BD992 GNSS Receiver

When using a Trimble BD992 GNSS receiver, the following configuration rules are applicable:

- For any given constellation, the first (1) frequency must be enabled in order to receive additional frequencies.
- Galileo and BeiDou are licensed separately, see [5.4 GNSS Receiver License Upgrades](#) for details.
- L Band corrections are available on this receiver, however require an additional subscription to Omnistar or RTX. Advanced Navigation does not supply these, contact Trimble for further details.

9.2.7.17 CAN Settings

The CAN Settings page allows you to enable or disable the CAN functionality. If the user is connecting to Certus via the primary port then these settings can be ignored. The default for CAN is Enabled at 1,000,000 baud rate. A CANOpen EDS file is available. Contact support@advancednavigation.com to obtain a copy of this file.

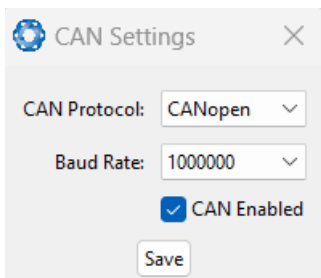

Figure 95: Manager CAN Settings Dialogue

9.2.8 Tools Menu

The **Tools** menu contains tools for performing certain procedures with Certus.

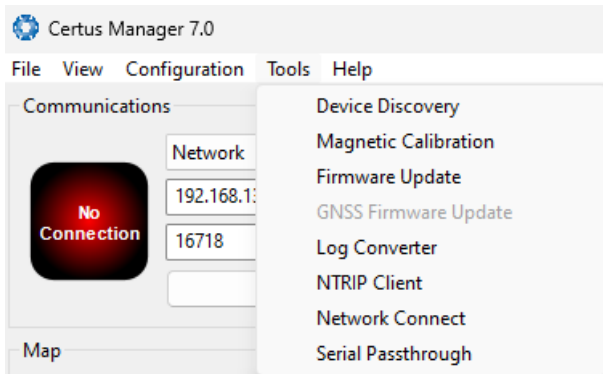

Figure 96: Manager Tools Menu

9.2.8.1 Device Discovery

Device discovery allows network discovery and reconfiguration of devices on the local network regardless of network settings.

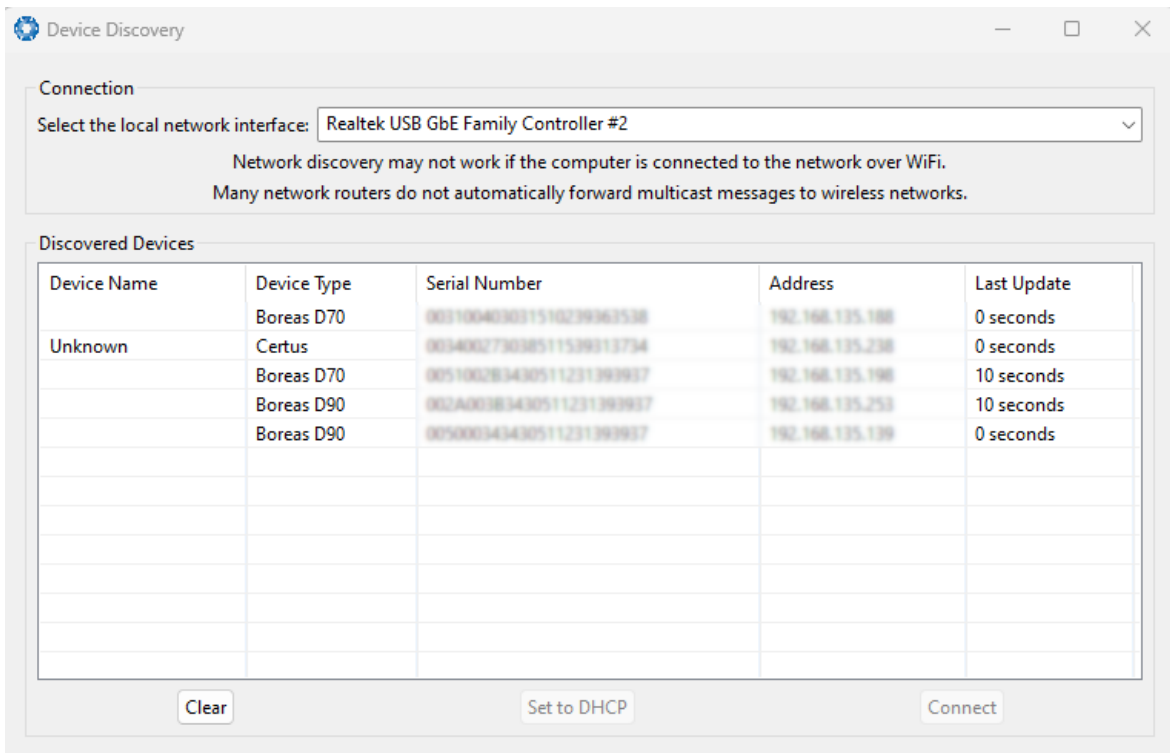

Figure 97: Device Discovery Dialogue

Set to DHCP

Once discovered devices on uncontactable network addresses can be reset to DHCP by pressing the “Set to DHCP” button for that device.

9.2.8.2 Magnetic Calibration

The Magnetic Calibration dialogue allows the user to perform magnetic calibration as well as view and modify the magnetic calibration values. The actual magnetic calibration is performed inside the Certus unit.

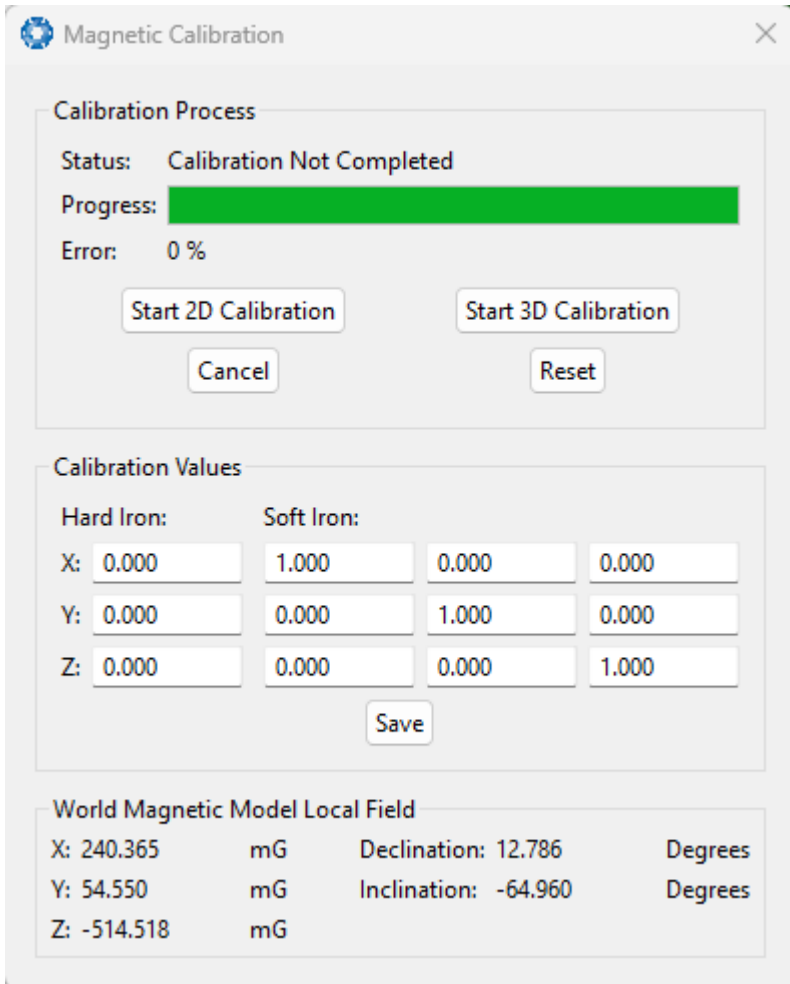

Figure 98: Manager Magnetic Calibration Dialogue

9.2.8.3 Firmware Update

This dialogue is used to update the Certus device firmware.

Certus contains firmware which is regularly updated to improve performance and add features. Advanced Navigation recommends that you upgrade to the latest version whenever available. The firmware update function is robust, such that power loss, file corruption or other issues cannot cause problems with units. Check the [Certus](#) product page of the Advanced Navigation website periodically for updates.

Note: Advanced Navigation device firmware files have the extension .anfw.

After the appropriate file is uploaded, the Firmware Update dialogue will display "**Firmware Update Ready**" in the status line.

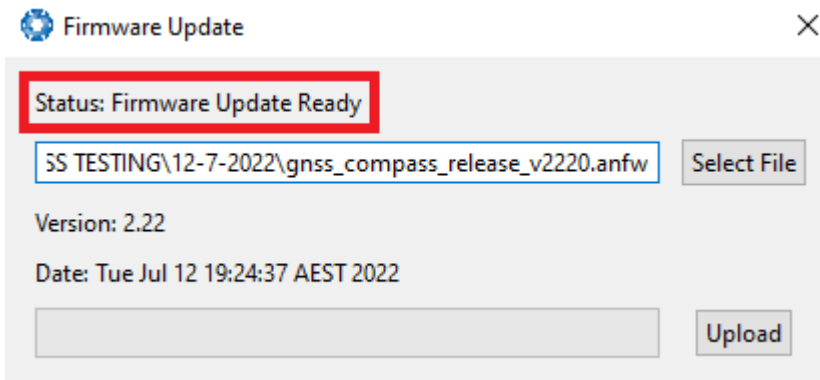

Figure 99: Firmware Update Ready Dialogue

Once the user clicks "upload", the dialogue status line will update to "**In Progress**"

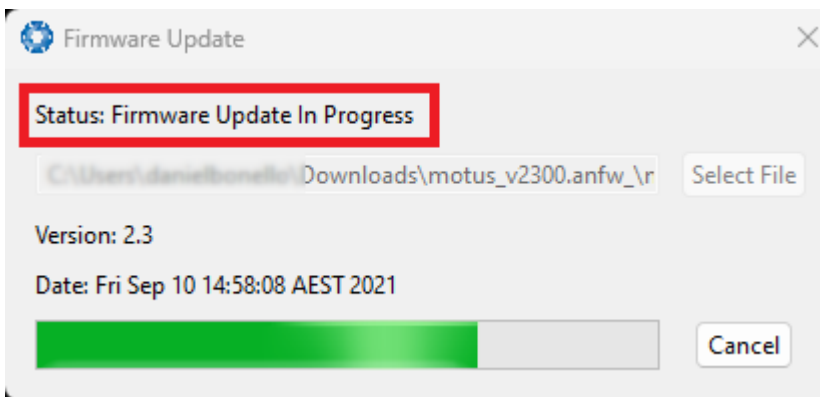

Figure 100: Firmware Update In Progress Dialogue

During this process, the user will notice the connection indicator change from "**Connected**" to "**Bootloader.**" This change confirms that the upload is functioning properly.

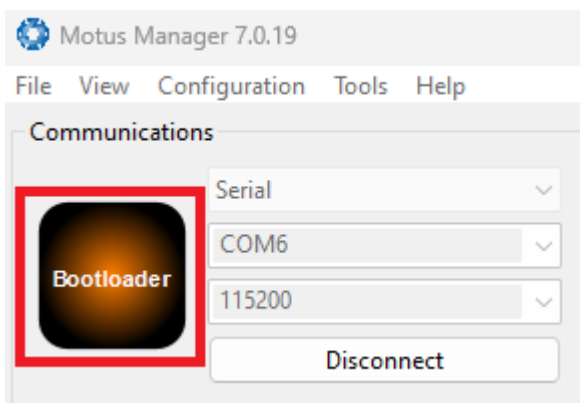

Figure 101: Firmware Update Bootloader Indicator

After the upload finishes, the system will restart. The device indicator will then display **"Connected,"** and the firmware update status line will show **"Complete."**



Figure 102: Firmware Update Complete Dialogue

After the update, the user can close the firmware update dialogue and verify the update by looking at the version in the Device Information dialogue, found under the view menu of the manager.

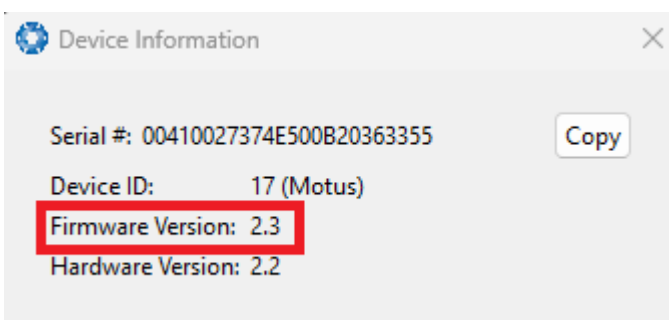

Figure 103: Device Information Dialogue

9.2.8.4 GNSS Firmware Update

Note: Refer to Firmware changelog to confirm which version of Trimble BD992 GNSS receiver firmware is compatible with the firmware being used in Certus

Follow these steps to upgrade the GNSS Receiver Firmware:

1. Navigate to the GNSS Receiver product support page to download the firmware version that is compatible with the product being used. [Trimble BD992 Firmware Download](#)

Note: On the Trimble BD992 support page, if the available firmware version is not supported by your product, please refer to the archived firmware section for older, compatible BD992 firmware versions.

2. Navigate to the GNSS Firmware Update page from the Tools menu (shown above)
3. Select **Select File** and select the downloaded file from the product support page.

Note: Ensure the format of the firmware file is of the .timg format

4. Select **Update**
5. When the process is complete, power cycle the device. To confirm the upgrade was successful, navigate to **View** → **GNSS Receiver Information**. The firmware version must match the version number in the firmware files.

Note: The process is anticipated to take several minutes, during which a progress bar and a percentage indicator should show the update's progress. Should the progress either halt or display an error, a power cycle of the device is recommended. After reconnecting, selecting 'Update' will restart the update process.



Figure 104: GNSS Receiver Firmware Upgrade Dialogue

9.2.8.5 Log Converter

This tool allows the user to convert Certus log files into various standard formats that are interchangeable and readable by many programs. The Position Offset settings are used to project the exported position of origin to a point other than the actual centre of the Certus unit. For most users, these values should be left at zero.

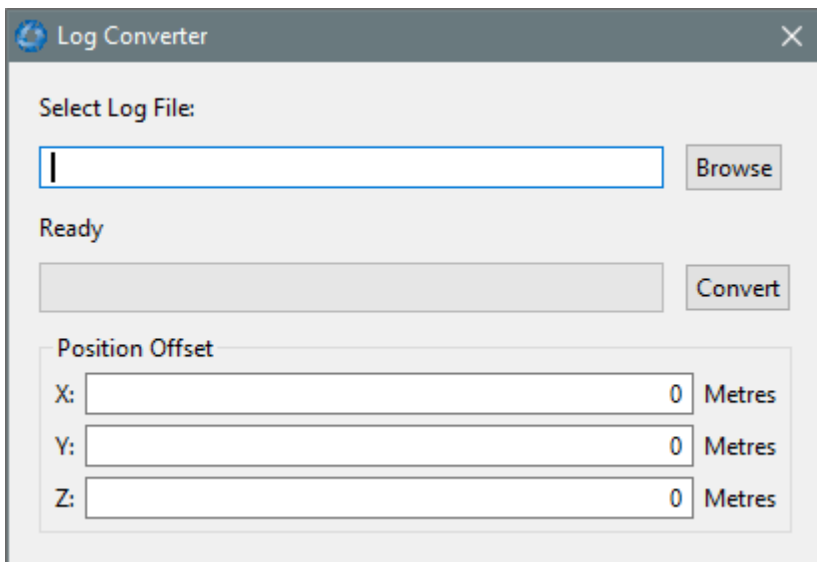

Figure 105: Manager Log Converter Dialogue

To configure the Log path, navigate to *Settings*, under the File menu.

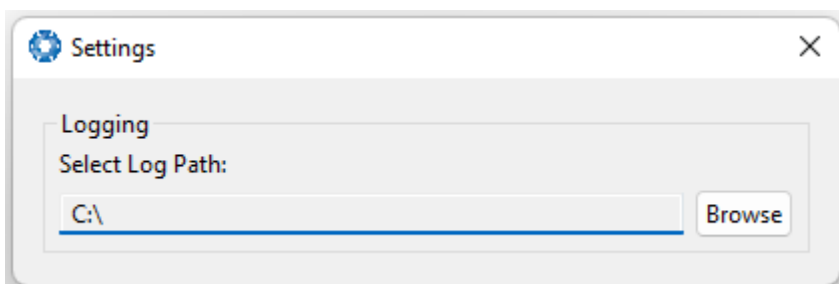

Figure 106: Settings menu for configuring Log Path

9.2.8.6 NTRIP Client

The NTRIP client can be used to connect to a network DGPS or RTK service to stream correction data to Certus for DGPS or RTK. The NTRIP client requires an internet connection to function. Contact [Support](#) for guidance on getting set up with network DGPS or RTK.

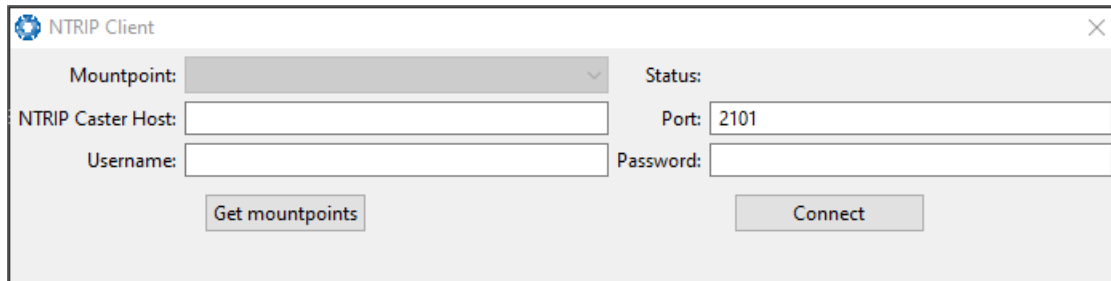

Figure 107: Manager NTRIP Client Dialogue

Note: These settings refer to the NTRIP Client built into the Certus . The Certus also contains a built in NTRIP client, to configure, this needs to be configured within the Certus webUI, see [9.1.3.13 NTRIP Client](#)

9.2.8.7 Network Connect

The network connect dialogue allows Certus Manager to make a connection to Certus over a TCP/IP network rather than the primary serial port connection.

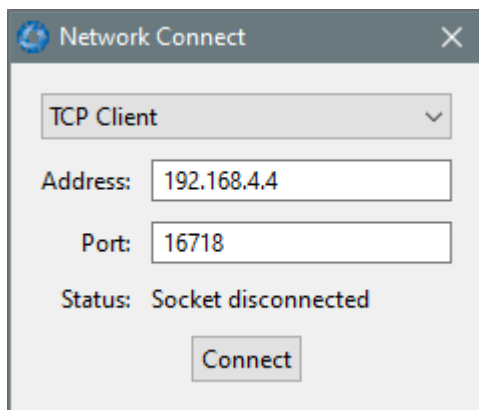

Figure 108: Manager Network Connect Dialogue

9.2.8.8 Serial Passthrough

This function allows pass-through communication through either GPIO 1 and 2 or the Auxiliary port.

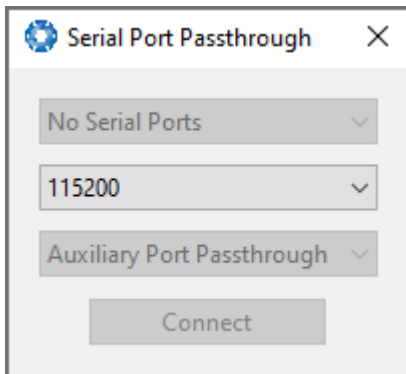

Figure 109: Manager Serial Port Passthrough Dialogue

9.2.9 Logging

Certus Manager features a fully automatic logging system. Every time the serial port **Connect** button is clicked Certus Manager starts a new log file in the current directory. The log file is given the file name CertusLog_date_time.anpp and contains all of the raw data received from Certus in the AN packet protocol. The log files are closed when the serial port is disconnected.

To convert these log files into easily accessible formats, the [9.2.8.5 Log Converter](#) dialogue in the **Tools** menu can be used. The Log Converter creates a folder if no Log Path is set and generates files in the CSV (comma separated values) format that can be easily opened with Microsoft Excel, Matlab, LibreOffice and most other data analysis programs. It also creates a GPX file and a KML file that are designed to be opened with [Google Earth Pro](#).

Name	Date modified	Type	Size
DeviceInformation.txt	4/11/2019 4:55 PM	TXT File	1 KB
Configuration.txt	4/11/2019 4:55 PM	TXT File	6 KB
Status.csv	4/11/2019 4:55 PM	Microsoft Excel Comma Separated Values File	24 KB
State.csv	4/11/2019 4:55 PM	Microsoft Excel Comma Separated Values File	16,322 KB
Satellites.csv	4/11/2019 4:55 PM	Microsoft Excel Comma Separated Values File	17 KB
RawSensors.csv	4/11/2019 4:55 PM	Microsoft Excel Comma Separated Values File	8,170 KB
GoogleEarthTrack.kml	4/11/2019 4:55 PM	KML	897 KB
GoogleEarthTrack.gpx	4/11/2019 4:55 PM	gpx_auto_file	236 KB

Figure 110: Files Generated by the Log Converter

Note: This data logging is performed by the Certus Manager application and is separate from the Certus inbuilt logging functionality accessible via the web UI.

9.3 Using the Android App

The Spatial Manager Android app provides logging and visualisation functions for Android phones and tablets. It is particularly useful for field testing purposes. You can use this app to connect to your Certus via Bluetooth and:

- Monitor position and orientation in real time
- Log real-time data for later analysis and review
- Configure NTRIP stream corrections
- Configure device sensor ranges, alignment offsets and manual initialisation

You will require a Serial to Bluetooth adaptor with Bluetooth v2.0 support connected to the primary serial port.

The app can be found by searching the Google Play store for "Advanced Navigation Spatial Manager". Refer to the in-app Quick Start guide for more information. Contact support@advancednavigation.com if you have any questions about the Android app.

9.4 Using ANPP

Certus can be configured and monitored using the Advanced Navigation Packet Protocol (ANPP), which is detailed fully in [11 Advanced Navigation Packet Protocol](#).

A software development kit (SDK) is available at no extra charge to assist you when developing your own applications. It contains example code in a number of programming languages, ready to compile and test. This is available from the Certus [product page](#).

10 Interfacing

Communication with Certus is possible on the following ports:

- [10.1 Ethernet](#)
- [10.2 Serial Interface](#)
- [10.4 CAN Interface](#)
- [10.3 1PPS Signal](#)
- [10.6 GPIO Pins and the Auxiliary Port](#)

Each port has different input and output capabilities.

10.1 Ethernet

The Ethernet interface offers a 100 MBit port for connection to a network, router or laptop/computer. The interface offers a [Web UI](#), as well as 4 (four) configurable data ports. Each Data Port

- can be configured as a TCP Server, TCP Client or a UDP Client as detailed in [10.1.1 Ethernet Modes](#)
- can be configured with an Input and/or Output for a number of protocols as detailed in [10.1 Ethernet](#).
- should only be used to establish a connection with a single remote computer/device at any one time.

10.1.1 Ethernet Modes

Ethernet Mode	Description	Required Configuration
TCP Server	Certus will establish a TCP Server listening on the defined port. A connected client is able to receive Output data and send Input data based on the defined Input and Output functions.	Port
TCP Client	Certus will continuously attempt to establish a TCP connection to the defined Destination IP and Port. Once established, a connected client is able to receive Output data and send Input data based on the defined Input and Output functions.	Client Destination IP address Port
UDP Client	Certus will send UDP Output data to the defined Destination IP and Port. A client can also send UDP Input data to Certus this same Port.	Client Destination IP address Port

Table 32: Ethernet Data Port Modes

10.1.2 Ethernet Functions

Function Type	Name
Ethernet Input	10.1.2.1 NMEA Input
	10.1.2.19 GNSS Receiver Passthrough
	10.1.2.2 Novatel GNSS Input
	10.1.2.3 Topcon GNSS Input
	10.1.2.4 ANPP Input
	10.1.2.5 RTCM Differential GNSS Corrections Input
	10.1.2.6 Trimble GNSS Input
	10.1.2.7 u-blox GNSS Input
	10.1.2.8 Hemisphere GNSS Input
	10.1.2.9 Teledyne DVL Input
	10.1.2.10 Trittech USBL Input
	10.1.2.11 Linkquest DVL Input
10.1.2.12 Nortek DVL Input	
Ethernet Output	10.1.2.13 NMEA Output
	10.1.2.14 ANPP Output
	10.1.2.15 TSS1 Output
	10.1.2.16 Simrad 1000 Output
	10.1.2.17 Simrad 3000 Output
	10.1.2.18 Serial Port Passthrough
	10.1.2.19 GNSS Receiver Passthrough

Table 33: Ethernet Data Port Functions

10.1.2.1 NMEA Input

Description: This function accepts external data in the NMEA 0183 format. Advanced Navigation recommends against using NMEA 0183 input wherever possible due to the inefficiency, low accuracy and precision and weak error checking of the format. All NMEA messages received must have a valid checksum. Supported messages are listed below. The recommended combination of messages are GPGGA, GPVTG and GPZDA with optional messages GPGSV and GPGSA.

Message ID	Description
GPGGA	3D position
GPGLL	2D position
GPRMC	2D position, 2D velocity and coarse time
GPVTG	2D velocity
GPHDT	Heading
GNHDT	
HEHDT	
GPGSV	Satellites
GPGSA	Dilution of Precision
GPZDA	Time
xxPIPS	Depth below surface
xxVBW	Water speed, ground speed
xxHDM	Magnetic heading
PSIMSSB	SSBL position
xxVHW	Water speed and heading
xxDBS	Depth below surface

Table 34: Supported NMEA messages

10.1.2.2 Novatel GNSS Input

Description: This function is designed for interfacing Certus with a Novatel GNSS receiver. It accepts data in the Novatel binary format and requires messages BESTPOS and BESTVEL at rates higher than 1 Hz (20Hz recommended). The message BESTSATS is optional to display detailed satellite information. The message HEADING is also supported for ALIGN capable receivers.

10.1.2.3 Topcon GNSS Input

Description: This function is designed for interfacing Certus with a Topcon GNSS receiver. It accepts data in the GRIL TPS binary format and expects messages PG and VG at rates higher than 1 Hz.

10.1.2.4 ANPP Input

Description: This function accepts data in the ANPP format as specified in [11 Advanced Navigation Packet Protocol](#).

10.1.2.5 RTCM Differential GNSS Corrections Input

Description: This function accepts RTCM v3 GNSS corrections messages. This allows for Differential GNSS or RTK with the Certus internal GNSS receiver.

10.1.2.6 Trimble GNSS Input

Description: This function is designed for interfacing Certus with an external Trimble GNSS receiver. It accepts data in the Trimble binary format GSOF and expects packet 0x40 with records 1, 2, 8, and 12 at rates higher than 1Hz (20Hz recommended) and optional records 9 and 34 at 1 to 2Hz.

10.1.2.7 u-blox GNSS Input

Description: This function is designed for interfacing Certus with an external u-blox GNSS receiver. It accepts data in the u-blox binary format and expects message NAV-PVT at rates higher than 1Hz.

10.1.2.8 Hemisphere GNSS Input

Description: This function is designed for interfacing Certus with an external Hemisphere GNSS receiver. It accepts data in the Hemisphere binary format and expects message Bin1 at rates higher than 1Hz. For Hemisphere receivers that provide heading using two antennas, NMEA should be used instead as the binary format does not allow for transmission of heading information.

10.1.2.9 Teledyne DVL Input

Description: This function accepts DVL data from a Teledyne DVL. For assistance with configuration, contact [Support](#).

10.1.2.10 Trittech USBL Input

Description: This function accepts USBL data from a Trittech USBL. For assistance with configuration, contact [Support](#).

10.1.2.11 Linkquest DVL Input

Description: This function accepts DVL data from a Linkquest DVL. The DVL should be configured to output in NQ1 format. For assistance with configuration, contact [Support](#).

10.1.2.12 Nortek DVL Input

Description: This function accepts DVL data in the Nortek DVL binary format. It accepts the packets

0x1B (DVL Bottom Track) and 0x1D (DVL Water Track). The recommended update rate is 8Hz.

10.1.2.13 NMEA Output

Description: This function outputs a configurable combination of the NMEA messages GPZDA, GPGGA, GPVTG, GPRMC, GPHDT, PASHR, GPROT, GPHEV, GPGSV, PFECGPAtt, and PFECGPHve at up to 50 Hz. The messages output and the output rate can be configured using the web UI or Certus Manager. An example output is shown below.

```
$GPZDA,031644.460,07,05,2013,00,00*52
$GPGGA,031644.460,3352.3501851,S,15112.2355488,E,6,00,1.4,150.0,M,0.0,M,,*7E
$GPVTG,089.19,T,089.19,M,000.00,N,000.00,K,E*27
$GPRMC,031644.460,A,3352.3501851,S,15112.2355488,E,0.0,89.2,070513,12.5,W,E*02
$GPHDT,89.2,T*06
$PASHR,031644.460,089.19,T,-00.01,-00.47,-00.00,,,,0,0*2E
```

10.1.2.14 ANPP Output

Description: This function outputs data in the ANPP format as specified in [11 Advanced Navigation Packet Protocol](#). This function is for ANPP peripheral devices only.

10.1.2.15 TSS1 Output

Description: This function outputs the TSS1 format at a user configurable rate of up to 50 Hz. The output rate can be configured using the page in the web UI.

10.1.2.16 Simrad 1000 Output

Description: This function outputs the Simrad 1000 format at a user configurable rate of up to 50 Hz. The output rate can be configured using the [9.1.3.3 Data Ports](#) page in the [9.1 Using the Web User Interface](#).

10.1.2.17 Simrad 3000 Output

Description: This function outputs the Simrad 3000 format at a user configurable rate up to 50 Hz. The output rate can be configured using the [9.1.3.3 Data Ports](#) page in the [9.1 Using the Web User Interface](#).

10.1.2.18 Serial Port Passthrough

Description: This function allows passthrough communication through either GPIO 1 and 2 or the Auxiliary port. To transmit data use the [11.3.7 Serial Port Passthrough Packet](#). When data is received it will be sent back using the same [11.3.7 Serial Port Passthrough Packet](#).

10.1.2.19 GNSS Receiver Passthrough

Description: This function allows for pass through connection to the internal GNSS receiver. This is useful for firmware updates of the internal GNSS receiver.

10.2 Serial Interface

There are two serial ports available for use. The GPIO port can also be used as a serial port, with less functionality.

Model	Primary Port	Auxiliary Port	GPIO Port
Certus	ANPP only over RS232 or RS422. No dynamic pin functions	ANPP over RS232 or RS422, 10.6.1 Dynamic Pin Functions	ANPP over RS232, 10.6.1 Dynamic Pin Functions

Table 35: I/O Ports Available

10.2.1 Baud Rate

The default baud rate of Certus is 115,200. The primary and auxiliary port baud rate can be set anywhere from 4,800 to 4,000,000 baud and can be modified using the Baud Rates page in the web UI or Certus Manager. The GPIO port baud rate can be set anywhere from 4,800 to 250,000 baud. It is important to select a baud rate that is capable of carrying the amount of data that Certus has been configured to output. See [11.1.4 Packet Rates](#) for more details on the data output calculation. The data rate in bytes per second can be calculated by dividing the baud rate by 10. For example if the baud rate is 115,200, the data rate is 11,520 bytes per second. If the selected data rate is insufficient, data may be lost without warning.

The support team can provide a baud rate calculator if it is required. For more information or assistance, contact technical support via email at support@advancednavigation.com.

10.2.2 Format

The format is fixed at 1 start bit, 8 data bits, 1 stop bit and no parity. See [11 Advanced Navigation Packet Protocol](#) for details on the ANPP protocol.

10.3 1PPS Signal

There is a dedicated 1PPS signal available on the [6.6 Connector Pin-out](#). See the [9.1.3.15 Advanced](#) section of the Configuration Menu for information on changing 1PPS and GPIO settings, and see [10.6.1 Dynamic Pin Functions](#) for information on 1PPS and GPIO output voltage.

The 1PPS signal reference ground is the GPIO ground domain. See [7.4 Electrical Domains](#) for more information.

The signal is normally low and pulses high for 100 milliseconds to signal the precise second, which starts on the rising edge of the signal.

This dedicated 1PPS signal is the recommended 1PPS signal to use as it is more accurate. The validity of this 1PPS signal can be monitored using the time initialised status flag.

10.4 CAN Interface

The CAN interface is available on the Connector Pin-out, and is used for low-level device integration with other vehicle systems.

A CANopen EDS file is available. Contact the Advanced Navigation support team at support@advancednavigation.com for a copy of this.

10.5 External Data

External sources of position, velocity and/or heading can be integrated into the Certus filter solution. The data can be sent to Certus in the ANPP format over the primary (RS232 or RS422), auxiliary (RS232 or RS422) or GPIO ports (RS232 only) or in a number of different formats. If using the ANPP format, use the table below to find the relevant section.

Packet
11.4.24 External Position and Velocity Packet
11.4.25 External Position Packet
11.4.26 External Velocity Packet
11.4.27 External Body Velocity Packet
11.4.28 External Heading Packet
11.4.32 External Time Packet
11.4.33 External Depth Packet
11.4.40 External Odometer Packet
11.4.41 External Air Data Packet
11.4.46 External Magnetometers Packet

Table 36: ANPP External Data Packets

10.6 GPIO Pins and the Auxiliary Port

In addition to the primary port and CAN port, Certus contains two general purpose input/output (GPIO) pins and an auxiliary port on the IO Breakout Connector. These pins are multi function and can be used to extend Certus with additional peripherals, sensors and data formats. Both GPIO pins have digital input, digital output, frequency input and frequency output functionality.

GPIO1 can also function as an RS232 (only) serial transmit line and GPIO2 can function as an RS232 (only) serial receive line. The GPIO serial baud rate can be configured anywhere from 4800 to 250 K baud. The auxiliary serial baud rate can be configured anywhere from 4800 to 4 M baud. See [11.5.3.1 Supported Baud Rate](#). Changes to these baud rates can be made by using the Baud Rates page in the [web UI](#) or [Certus Manager](#).

The available GPIO and auxiliary functions are listed in the section [10.6.1 Dynamic Pin Functions](#). The function of a GPIO pin or the auxiliary port can be changed at any time using the GPIO Configuration page in the Certus [web UI](#) or [Manager](#). GPIO 1 and GPIO 2 operate at standard voltage levels for digital input, digital output, frequency input and frequency output, but when a serial data function is selected, this GPIO pin automatically switches to RS232 voltage level.

10.6.1 Dynamic Pin Functions

Function Type	Name	
Tristate	10.6.1.1 Inactive	
Digital Output	10.6.1.2 1PPS Output	
	10.6.1.3 GNSS Fix Output	
Digital Input	10.6.1.4 Zero Velocity Input	
	10.6.1.5 Disable Magnetometers	
	10.6.1.6 Disable GNSS	
	10.6.1.7 Disable Pressure	
	10.6.1.8 Set Zero Orientation Alignment	
	10.6.1.9 System State Packet Trigger	
	10.6.1.10 Raw Sensors Packet Trigger	
	10.6.1.11 1PPS Input	
	10.6.1.12 Event 1 Input	
	10.6.1.13 Event 2 Input	
	10.6.1.14 Odometer Direction, Forward Low	
	10.6.1.15 Odometer Direction, Forward High	
	10.6.1.16 Reverse Alignment, Forward Low	
	10.6.1.17 Reverse Alignment, Forward High	
	10.6.1.18 Zero Angular Velocity Input	
	Frequency Input	10.6.1.19 Odometer Input
		10.6.1.20 Pitot Tube Input
		10.6.1.21 Pressure Depth Transducer (deprecated)
10.6.1.22 Left Wheel Speed Sensor		
10.6.1.23 Right Wheel Speed Sensor		
10.6.1.24 Wheel Speed Sensor		
10.6.1.25 Wheel Encoder Phase A		
10.6.1.26 Wheel Encoder Phase B		
10.6.1.27 Gimbal Encoder Phase A		
10.6.1.28 Gimbal Encoder Phase B		

Function Type	Name
Serial Receive	10.6.1.29 NMEA Input
	10.6.1.30 Novatel GNSS Input
	10.6.1.31 Topcon GNSS Input
	10.6.1.32 ANPP Input
	10.6.1.33 RTCM Differential GNSS Corrections Input
	10.6.1.34 Trimble GNSS Input
	10.6.1.35 u-blox GNSS Input
	10.6.1.36 Hemisphere GNSS Input
	10.6.1.37 Teledyne DVL Input
	10.6.1.38 Trittech USBL Input
	10.6.1.39 Linkquest DVL Input
	10.6.1.40 Linkquest USBL Input
10.6.1.41 Nortek DVL Input	
Serial Transmit	10.6.1.42 NMEA Output
	10.6.1.43 ANPP Output
	10.6.1.44 TSS1 Output
	10.6.1.45 Simrad 1000 Output
	10.6.1.46 Simrad 3000 Output
Serial	10.6.1.47 Serial Port Passthrough
	10.6.1.48 GNSS Receiver Passthrough

Table 37: Dynamic Pin Functions

10.6.1.1 Inactive

Type: Tristate
GPIO Port: 1, 2
Auxiliary: All

10.6.1.2 1PPS Output

Type: Digital Output
GPIO Port: 1, 2
Auxiliary: Transmit
Description: There is a difference between the output of the GPIO and auxiliary ports when set to 1PPS output mode.

1PPS Source	Voltage Level	Trigger
Auxiliary	-5 V to 5 V	Falling Edge
GPIO	0 to 5 V, 0 to 3.3 V	Rising Edge

Figure 111: 1PPS Specifications

The pin is normally low and pulses high for 50 milliseconds to signal the precise second. The 1PPS line starts pulsing approximately 100 milliseconds after power up and always fires irrespective of whether Certus has accurate time or not. It is important to note that when Certus acquires time corrections from its GNSS receiver, the 1PPS signal may fire at an interval of less than 1 second. This typically only occurs the first time the GNSS receiver obtains a fix after startup. The time initialised status flag can be used to determine whether the time and 1PPS line is accurate or not.

The dedicated [10.3 1PPS Signal](#) on the Connector Pin-out is the recommended 1PPS signal to use as it comes direct from the internal GNSS receiver rather than the internal microprocessor. The validity of the dedicated 1PPS signal can be monitored using the “time initialised” flag in the [11.4.1 System State Packet](#).

10.6.1.3 GNSS Fix Output

Type: Digital Output
GPIO Port: 1, 2
Auxiliary: Transmit
Description: In this function, the pin is low when there is no GNSS fix or a 2D fix and high when there is a 3D, SBAS, Differential or RTK GNSS fix.

10.6.1.4 Zero Velocity Input

Type: Digital Input
GPIO Port: 1, 2
Auxiliary: Receive
Description: When using this function, a high state indicates to Certus that it is stationary. The low state indicates that the vehicle is not stationary. Use of this function can prevent drift during periods when a GNSS signal is not available.

10.6.1.5 Disable Magnetometers

Type: Digital Input
GPIO Port: All
Auxiliary: Receive
Description: This function accepts a digital input with a low state enabling the magnetometers and a high state disabling the magnetometers.

10.6.1.6 Disable GNSS

Type: Digital Input

GPIO Port:	1, 2
Auxiliary:	Receive
Description:	This function accepts a digital input with a low state enabling the GNSS and a high state disabling the GNSS.

10.6.1.7 Disable Pressure

Type:	Digital Input
GPIO Port:	1, 2
Auxiliary:	Receive
Description:	This function accepts a digital input with a low state enabling the atmospheric pressure sensor and a high state disabling the atmospheric pressure sensor.

10.6.1.8 Set Zero Orientation Alignment

Type:	Digital Input
GPIO Port:	1, 2
Auxiliary:	Receive
Description:	This function accepts a digital input. The input is normally low and a transition from low to high causes Certus to set its alignment so that the current orientation is zero. Due to the risk of exhausting the flash cycles, the change is not permanent and will disappear on reset. To make it permanent the 11.5.5 Installation Alignment Packet must be read and then sent back to Certus with the permanent flag set. This function requires de-bouncing if attached to a switch.

10.6.1.9 System State Packet Trigger

Type:	Digital Input
GPIO Port:	1, 2
Auxiliary:	Receive
Description:	This function accepts a digital input. The input is normally low and a transition from low to high causes Certus to send the System State Packet. This function requires de-bouncing if attached to a switch.

10.6.1.10 Raw Sensors Packet Trigger

Type:	Digital Input
GPIO Port:	1, 2
Auxiliary:	Receive
Description:	This function accepts a digital input. The input is normally low and a transition from low to high causes Certus to send the 11.4.9 Raw Sensors Packet . This function requires de-bouncing if attached to a switch.

10.6.1.11 1PPS Input

Type:	Digital Input
GPIO Port:	1, 2
Auxiliary:	Receive
Description:	This function is designed to allow external GNSS receivers to synchronise time with Certus. It triggers on a transition from low to high.

10.6.1.12 Event 1 Input

Type:	Digital Input
GPIO Port:	1, 2
Auxiliary:	Receive
Description:	This function is designed to allow external events to be recorded by Certus. The event is recorded in the Filter Status (see 11 Advanced Navigation Packet Protocol), and resets after the next packet is output. The event triggers on a transition from low to high.

10.6.1.13 Event 2 Input

Type:	Digital Input
GPIO Port:	1, 2
Auxiliary:	Receive
Description:	This function is designed to allow external events to be recorded by Certus. The event is recorded in the Filter Status (see 11 Advanced Navigation Packet Protocol), and resets after the next packet is output. The event triggers on a transition from low to high.

10.6.1.14 Odometer Direction, Forward Low

Type:	Digital Input
GPIO Port:	1, 2
Auxiliary:	Receive
Description:	This function is designed to take a reversing indication input for direction with an odometer or wheel encoder. It should be used in combination with Odometer Input or Wheel Speed Sensor.

10.6.1.15 Odometer Direction, Forward High

Type:	Digital Input
GPIO Port:	1, 2
Auxiliary:	Receive
Description:	This function is designed to take a reversing indication input for direction with an odometer or wheel encoder. It should be used in combination with Odometer Input or Wheel Speed Sensor.

10.6.1.16 Reverse Alignment, Forward Low

Type: Digital Input
GPIO Port: 1, 2
Auxiliary: Receive
Description: This function is designed to reverse the alignment settings for vehicles that can have two vehicle forward directions, such as locomotives.

10.6.1.17 Reverse Alignment, Forward High

Type: Digital Input
GPIO Port: 1, 2
Auxiliary: Receive
Description: This function is designed to reverse the alignment settings for vehicles that can have two vehicle forward directions, such as locomotives.

10.6.1.18 Zero Angular Velocity Input

Type: Digital Input
GPIO Port: 1, 2
Auxiliary: Receive
Description: In this function, a high state indicates to Certus that the vehicle is not rotating. The low state indicates that the vehicle could be rotating. Use of this function can significantly improve heading drift performance when a GNSS signal is not available.

10.6.1.19 Odometer Input

Type: Frequency Input
GPIO Port: 1, 2
Auxiliary: Receive
Description: This function is designed for low-resolution vehicle speed sensors and odometers. It expects a normally low input with a high state for the trigger. If the pulse length is more than 0.1 metres then this odometer input function should be used. If it is less than 0.1 metres, the wheel speed sensor function should be used. Contact technical support at support@advancednavigation.com for help integrating with your speed sensor.

Parameter	Value
Trigger	Low → High
Maximum Frequency	600 Khz
Maximum Pulse Rate	4294967 pulses/metre

Table 38: Odometer Specifications

10.6.1.20 Pitot Tube Input

Type:	Frequency Input
GPIO Port:	1, 2
Auxiliary:	Receive
Description:	This function allows fixed wing aircraft to measure airspeed to improve navigation performance. It requires a differential pressure sensor that has a frequency output such as the Kavlico P992 (frequency output option) or the Paroscientific series 5300. Contact technical support at support@advancednavigation.com for help integrating with a pitot tube.

10.6.1.21 Pressure Depth Transducer (deprecated)

Type:	Frequency Input
GPIO Port:	1, 2
Auxiliary:	Receive
Description:	This function is designed for interfacing with a legacy pressure depth transducer. These are no longer available and the function is now deprecated.

10.6.1.22 Left Wheel Speed Sensor

Type:	Frequency Input
GPIO Port:	1, 2
Auxiliary:	Receive
Description:	This function is designed for the left wheel of a vehicle with dual wheel speed sensors.

10.6.1.23 Right Wheel Speed Sensor

Type:	Frequency Input
GPIO Port:	1, 2
Auxiliary:	Receive
Description:	This function is designed for the right wheel of a vehicle with dual wheel speed sensors.

10.6.1.24 Wheel Speed Sensor

Type:	Frequency Input
GPIO Port:	1, 2
Auxiliary:	Receive
Description:	This function is designed for high resolution vehicle speed sensors and wheel speed sensors. It expects a normally low input with a high state for the trigger. If the pulse length is more than 0.1 metres the odometer input function should be used, if it is less than 0.1 metres the wheel speed sensor function should be used. Contact technical support via

email at support@advancednavigation.com for with help integrating with your speed sensor.

Parameter	Value
Trigger	Low → High
Maximum Frequency	40 MHz
Maximum Pulse Rate	4,294,967,295 pulses/metre

Table 39: Wheel Speed Sensor Specifications

10.6.1.25 Wheel Encoder Phase A

Type: Frequency Input
GPIO Port: 1, 2
Auxiliary: N/A
Description: This function is designed for rotary incremental quadrature encoders. It should be used in combination with Wheel Encoder Phase B.

10.6.1.26 Wheel Encoder Phase B

Type: Frequency Input
GPIO Port: 1, 2
Auxiliary: N/A
Description: This function is designed for rotary incremental quadrature encoders. It should be used in combination with Wheel Encoder Phase A.

10.6.1.27 Gimbal Encoder Phase A

Type: Frequency Input
GPIO Port: 1, 2
Auxiliary: N/A
Description: This function is designed for interfacing with a rotary incremental quadrature encoder to measure the azimuth angle of a gimbal in which Certus is installed. It should be used in combination with Gimbal Encoder Phase B.

10.6.1.28 Gimbal Encoder Phase B

Type: Frequency Input
GPIO Port: 1, 2
Auxiliary: N/A
Description: This function is designed for interfacing with a rotary incremental quadrature encoder to measure the azimuth angle of a gimbal in which Certus is installed. It should be used in combination with [Gimbal Encoder Phase A](#).

10.6.1.29 NMEA Input

Type: Serial Receive

GPIO Port: 2

Auxiliary: Receive

Description: This function accepts external data in the NMEA 0183 format. Advanced Navigation recommends against using NMEA 0183 input wherever possible due to the inefficiency, low accuracy and precision and weak error checking of the format. All NMEA messages received must have a valid checksum. Supported messages are listed below. The recommended combination of messages are GPGGA and GPVT with optional messages GPGSV and GPGSA.

Message ID	Description
GPGGA GNGGA	3D position
GPGLL GNGLL	2D position
GPRMC GNRMC	2D position, 2D velocity and coarse time
GPVTG GNVTG	2D velocity
GPHDT GNHDT HEHDT	Heading
GPGSV GNGSV	Satellites
GPGSA GNGSA	Dilution of Precision
xxPIPS	Depth below surface
xxVBW	Water speed, ground speed
xxHDM	Magnetic heading
PSIMSSB	SSBL position
xxVHW	Water speed and heading
xxDBS	Depth below surface

Table 40: Supported NMEA messages

10.6.1.30 Novatel GNSS Input

Type: Serial Receive

GPIO Port: 2

Auxiliary: Receive

Description: This function is designed for interfacing Certus with a Novatel GNSS receiver. It accepts data in the Novatel binary format and requires messages BESTPOSB and BESTVELB at rates higher than 1 Hz (20 Hz recommended). The message BESTSATSB is optional to display detailed satellite information. The message HEADING is also supported for ALIGN capable receivers.

10.6.1.31 Topcon GNSS Input

Type:	Serial Receive
GPIO Port:	2
Auxiliary:	Receive
Description:	This function is designed for interfacing Certus with a Topcon GNSS receiver. It accepts data in the GRIL TPS binary format and expects messages PG and VG at rates higher than 1 Hz.

10.6.1.32 ANPP Input

Type:	Serial Receive
GPIO Port:	2
Auxiliary:	Receive
Description:	<p>This function accepts data in the ANPP format as specified in 11 Advanced Navigation Packet Protocol.</p> <p>When this function is enabled, the GPIO and auxiliary ports function the same as the primary port, with one exception:</p> <ul style="list-style-type: none"> • When setting the ANPP packet and message output rates, the changes only apply to the port you are connected to. For example, you cannot change the primary port or GPIO port packet and message rates when connected to the auxiliary port.

10.6.1.33 RTCM Differential GNSS Corrections Input

Type:	Serial Receive
GPIO Port:	2
Auxiliary:	Receive
Description:	This function accepts RTCM v3 GNSS corrections messages. This allows for Differential GNSS or RTK with the Certus internal GNSS receiver.

10.6.1.34 Trimble GNSS Input

Type:	Serial Receive
GPIO Port:	2
Auxiliary:	Receive
Description:	This function is designed for interfacing Certus with an external Trimble GNSS receiver. It accepts data in the Trimble binary format GSOF and expects packet 0x40 with records 1, 2, 8, and 12 at rates higher than 1Hz (20 Hz recommended) and optional records 9 and 34 at 1 to 2 Hz.

10.6.1.35 u-blox GNSS Input

Type:	Serial Receive
--------------	----------------

GPIO Port: 2
Auxiliary: Receive
Description: This function is designed for interfacing Certus with an external u-blox GNSS receiver. It accepts data in the u-blox binary format and expects message NAV-PVT at rates higher than 1 Hz.

10.6.1.36 Hemisphere GNSS Input

Type: Serial Receive
GPIO Port: 2
Auxiliary: Receive
Description: This function is designed for interfacing Certus with an external Hemisphere GNSS receiver. It accepts data in the Hemisphere binary format and expects message Bin1 at rates higher than 1 Hz. For Hemisphere receivers that provide heading using two antennas, NMEA should be used instead as the binary format does not allow for transmission of heading information.

10.6.1.37 Teledyne DVL Input

Type: Serial Receive
GPIO Port: 2
Auxiliary: Receive
Description: This function accepts DVL data from a Teledyne DVL. For assistance with configuration, contact support@advancednavigation.com.

10.6.1.38 Trittech USBL Input

Type: Serial Receive
GPIO Port: 2
Auxiliary: Receive
Description: This function accepts USBL data from a Trittech USBL. For assistance with configuration, contact support@advancednavigation.com.

10.6.1.39 Linkquest DVL Input

Type: Serial Receive
GPIO Port: 2
Auxiliary: Receive
Description: This function accepts DVL data from a Linkquest DVL. For assistance with configuration, contact support@advancednavigation.com.

10.6.1.40 Linkquest USBL Input

Type: Serial Receive

GPIO Port: 2
Auxiliary: Receive
Description: This function accepts USBL data from a Linkquest USBL. For assistance with configuration, contact support@advancednavigation.com.

10.6.1.41 Nortek DVL Input

Type: Serial Receive
GPIO Port: 2
Auxiliary: Receive
Description: This function accepts DVL data in the Nortek DVL binary format. It accepts the packets 0x1B (DVL Bottom Track) and 0x1D (DVL Water Track). The recommended update rate is 8 Hz.

10.6.1.42 NMEA Output

Type: Serial Transmit
GPIO Port: 1
Auxiliary: Transmit
Description: This function outputs a configurable combination of the NMEA messages GPZDA, GPGGA, GPVTG, GPRMC, GPHDT, PASHR, GPROT, GPHEV, GPGSV, PFECGPAtt, and PFECGPHve at up to 50 Hz. The messages output and the output rate can be configured using the web UI or Certus Manager. An example output is shown below.

```
$GPZDA,031644.460,07,05,2013,00,00*52
$GPGGA,031644.460,3352.3501851,S,15112.2355488,E,6,00,1.4,150.0,M,0.0,M,,*7E
$GPVTG,089.19,T,089.19,M,000.00,N,000.00,K,E*27
$GPRMC,031644.460,A,3352.3501851,S,15112.2355488,E,0.0,89.2,070513,12.5,W,E*02
$GPHDT,89.2,T*06
$PASHR,031644.460,089.19,T,-00.01,-00.47,-00.00,,,,,0,0*2E
```

10.6.1.43 ANPP Output

Type: Serial Transmit
GPIO Port: 1
Auxiliary: Transmit
Description: This function outputs data in the ANPP format as specified in [11 Advanced Navigation Packet Protocol](#). This function is for ANPP peripheral devices only.
 When this function is enabled, the GPIO and auxiliary ports function the same as the primary port, with one exception:

- When setting the ANPP packet and message output rates, the changes only apply to the port you are connected to. For example, you cannot change the primary port or GPIO port packet and message rates when connected to the auxiliary port.

10.6.1.44 TSS1 Output

Type:	Serial Transmit
GPIO Port:	1
Auxiliary:	Transmit
Description:	This function outputs the TSS1 format at a user configurable rate of up to 50 Hz. The output rate can be configured using the page in the web UI.

10.6.1.45 Simrad 1000 Output

Type:	Serial Transmit
GPIO Port:	1
Auxiliary:	Transmit
Description:	This function outputs the Simrad 1000 format at a user configurable rate of up to 50 Hz. The output rate can be configured using the 9.1.3.6 GPIO page in the web UI or the 9.2.7.11 GPIO Output dialogue in the Certus Manager.

10.6.1.46 Simrad 3000 Output

Type:	Serial Transmit
GPIO Port:	1
Auxiliary:	Transmit
Description:	This function outputs the Simrad 3000 format at a user configurable rate up to 50 Hz. The output rate can be configured using the 9.1.3.6 GPIO page in the web UI or the 9.2.7.11 GPIO Output dialogue in the Certus Manager.

10.6.1.47 Serial Port Passthrough

Type:	Serial
GPIO Port:	1, 2
Auxiliary:	All
Description:	This function allows passthrough communication through either GPIO 1 and 2 or the Auxiliary port. To transmit data use the 11.3.7 Serial Port Passthrough Packet . When data is received it will be sent back using the same 11.3.7 Serial Port Passthrough Packet .

10.6.1.48 GNSS Receiver Passthrough

Type:	Serial
GPIO Port:	1, 2

Auxiliary: All

Description: This function allows for pass through connection to the internal GNSS receiver. This is useful for firmware updates of the internal GNSS receiver.

11 Advanced Navigation Packet Protocol

The Advanced Navigation Packet Protocol (ANPP) is a binary protocol designed with high error checking, high efficiency and safe design practices. It has a well defined specification and is very flexible. ANPP is proprietary and is used across all Advanced Navigation products. A packet type can be identified by its unique Packet ID. For more information about packets, see [11.1 About Packets](#).

The following packet types are available:

- [11.3 System Packets](#) - These packets have ID values of less than 20.
- [11.4 State Packets](#) - These packets have ID values between 20 and 179.
- [11.5 Configuration Packets](#) - These packets have IDs greater than 179.

The following table lists Advanced Navigation packets by type.

Packet ID	Name	Length	R/W
System Packets			
0	11.3.1 Acknowledge Packet	4	R
1	11.3.2 Request Packet	Varies	W
2	11.3.3 Boot Mode Packet	1	R/W
3	11.3.4 Device Information Packet	24	R
4	11.3.5 Restore Factory Settings Packet	4	W
5	11.3.6 Reset Packet	4	W
10	11.3.7 Serial Port Passthrough Packet	Varies	R/W
11	11.3.8 IP Configuration Packet	30	R/W
13	11.3.9 Extended Device Information Packet	36	R
14	11.3.10 Subcomponent Information Packet	24	R
State Packets			
20	11.4.1 System State Packet	100	R
21	11.4.2 Unix Time Packet	8	R
22	11.4.3 Formatted Time Packet	14	R
23	11.4.4 Status Packet	4	R
24	11.4.5 Position Standard Deviation Packet	12	R
25	11.4.6 Velocity Standard Deviation Packet	12	R
26	11.4.7 Euler Orientation Standard Deviation Packet	12	R
27	11.4.8 Quaternion Orientation Standard Deviation Packet	16	R
28	11.4.9 Raw Sensors Packet	48	R
29	11.4.10 Raw GNSS Packet	74	R/W
30	11.4.11 Satellites Packet	13	R

Packet ID	Name	Length	R/W
32	11.4.12 Geodetic Position Packet	24	R
33	11.4.13 ECEF Position Packet	24	R
34	11.4.14 UTM Position Packet	26	R
35	11.4.15 NED Velocity Packet	12	R
36	11.4.16 Body Velocity Packet	12	R
37	11.4.17 Acceleration Packet	12	R
38	11.4.18 Body Acceleration Packet	16	R
39	11.4.19 Euler Orientation Packet	12	R
40	11.4.20 Quaternion Orientation Packet	16	R
41	11.4.21 DCM Orientation Packet	36	R
42	11.4.22 Angular Velocity Packet	12	R
43	11.4.23 Angular Acceleration Packet	12	R
44	11.4.24 External Position and Velocity Packet	60	R/W
45	11.4.25 External Position Packet	36	R/W
46	11.4.26 External Velocity Packet	24	R/W
47	11.4.27 External Body Velocity Packet	16 or 24	R/W
48	11.4.28 External Heading Packet	8	R/W
49	11.4.29 Running Time Packet	8	R
50	11.4.30 Local Magnetic Field Packet	12	R
51	11.4.31 Odometer State Packet	20	R
52	11.4.32 External Time Packet	8	W
53	11.4.33 External Depth Packet	8	R/W
54	11.4.34 Geoid Height Packet	4	R
55	11.4.35 RTCM Corrections Packet	Varies	W
57	11.4.36 Wind Packet	12	R/W
58	11.4.37 Heave Packet	16	R
60	11.4.38 Raw Satellite Data Packet	Varies	R
61	11.4.39 Raw Satellite Ephemeris Packet	Varies	R
67	11.4.40 External Odometer Packet	13	W
68	11.4.41 External Air Data Packet	25	R/W
69	11.4.42 GNSS Receiver Information Packet	Varies	R
70	11.4.43 Raw DVL Data Packet	60	R/W
72	11.4.44 Gimbal State Packet	8	R/W
73	11.4.45 Automotive Packet	24	R

Packet ID	Name	Length	R/W
75	11.4.46 External Magnetometers Packet	17	R/W
80	11.4.47 Basestation Packet	45	R
83	11.4.48 Zero Angular Velocity Packet	8	W
84	11.4.49 Extended Satellites Packet	Varies	R
85	11.4.50 Sensor Temperature Packet	32	R
Packet ID	Name	Length	R/W
Configuration Packets			
180	11.5.1 Packet Timer Period Packet	4	R/W
181	11.5.2 Packets Period Packet	Varies	R/W
182	11.5.3 Baud Rates Packet	17	R/W
184	11.5.4 Sensor Ranges Packet	4	R/W
185	11.5.5 Installation Alignment Packet	73	R/W
186	11.5.6 Filter Options Packet	17	R/W
188	11.5.7 GPIO Configuration Packet	13	R/W
189	11.5.8 Magnetic Calibration Values Packet	49	R/W
190	11.5.9 Magnetic Calibration Configuration Packet	1	W
191	11.5.10 Magnetic Calibration Status Packet	3	R
192	11.5.11 Odometer Configuration Packet	8	R/W
193	11.5.12 Set Zero Orientation Alignment Packet	5	W
194	11.5.13 Reference Point Offsets Packet	49	R/W
195	11.5.14 GPIO Output Configuration Packet	183	R/W
196	11.5.15 Dual Antenna Configuration Packet	17	R/W
197	11.5.16 GNSS Configuration Packet	85	R/W
198	11.5.17 User Data Packet	64	R/W
199	11.5.18 GPIO Input Configuration Packet	65	R/W
202	11.5.19 IP Dataports Configuration Packet	30	R/W
203	11.5.20 CAN Configuration Packet	30	R/W

Table 41: Advanced Navigation Packets

11.1 About Packets

11.1.1 Packet Structure

The ANPP packet structure and the header format are shown in the tables below. Example source code is provided in multiple languages via the SDK, available from the [Certus](#) product page of the Advanced Navigation website.

Header				
Header LRC	Packet ID	Packet Length	CRC16	Packet Data

Table 42: ANPP Packet Structure

Field #	Bytes Offset	Data Type	Size	Description
1	0	u8	1	Header LRC
2	1	u8	1	Packet ID
3	2	u8	1	Packet Length
4	3	u16	2	CRC

Table 43: ANPP Header Format

11.1.1.1 Header LRC

The header LRC (Longitudinal Redundancy Check) provides error checking on the packet header. It also allows the decoder to find the start of a packet by scanning for a valid LRC. Only the lower 8 bits of the calculation below are provided in the LRC field of the packet header. The LRC can be found using the following:

$$LRC = (PacketID + PacketLength + crc_0 + crc_1) \oplus 0xFF + 1$$

11.1.1.2 Packet ID

The packet ID is used to distinguish the contents of the packet. Packet IDs range from 0 to 255. See [11. Advanced Navigation Packet Protocol](#).

System packets have packet IDs in the range 0 to 19. These packets are implemented the same by every device using ANPP.

State packets are packets that contain data that changes with time, i.e. temperature. State packets can be set to output at a certain rate. State packets are packet IDs in the range 20 to 179.

Configuration packets are used for reading and writing device configuration. Configuration packets are packet IDs in the range 180 to 255.

11.1.1.3 Packet Length

The packet length denotes the length of the packet data, i.e. from byte index 5 onwards inclusive. Packet length has a range of 0 – 255.

11.1.1.4 CRC

The CRC is a CRC16-CCITT. The starting value is 0xFFFF. The CRC covers only the packet data.

11.1.2 Packet Requests

Any of the state and configuration packets can be requested at any time using the [11.3.2 Request Packet](#).

11.1.3 Packet Acknowledgement

When configuration packets are sent to Certus, it will reply with an acknowledgement packet that indicates whether the configuration change was successful or not. See [11.3.1 Acknowledge Packet](#).

External data packets will also generate negative acknowledgement packets if there is a problem with the packet. Positive acknowledgements will not be sent. See [10.5 External Data](#) for a list of External Data Packets.

11.1.4 Packet Rates

The packet rates can be configured either using the web UI, or Certus Manager or through the [11.5.2 Packets Period Packet](#). By default Certus is configured to output the [11.4.1 System State Packet](#) at 20 Hz and the [11.4.9 Raw Sensors Packet](#) at 20 Hz. When configuring packet rates it is essential to ensure the baud rate is capable of handling the data throughput. This can be calculated using the rate and packet size. The packet size is calculated by adding the packet overhead to the packet length; the packet overhead is a fixed value of 5. For example to output the system state packet at 50Hz the calculation would be:

$$\text{Data throughput} = (100 (\text{packet length}) + 5 (\text{fixed packet overhead})) * 50 (\text{rate})$$

$$\text{Data throughput} = 5250 \text{ bytes per second}$$

$$\text{Minimum baud rate} = \text{data throughput} * 11 = 57750 \text{ Baud}$$

$$\text{Closest standard baud rate} = 115200 \text{ Baud}$$

When multiple packets are set to output at the same rate, the order the packets output is from lowest ID to highest ID.

11.1.5 Packet Timing

Packets are output in order of packet ID from lowest ID to highest ID and all packets that are output in one sequence have their data matched to the same time of validity. The time of validity can be found in either the [11.4.1 System State Packet](#), the [11.4.2 Unix Time Packet](#) or the [11.4.3 Formatted Time Packet](#). For example if the [11.4.2 Unix Time Packet](#), [11.4.4 Status Packet](#) and [11.4.15 NED Velocity Packet](#) packet were all set to output at 10 Hz, at each 0.1 second period the three packets would output consecutively by order of packet ID with all data synchronised between them and the [11.4.2 Unix Time Packet](#) providing the time of validity for the other two packets.

11.2 Data Types

The following data types are used in the packet protocol. All data types in the protocol are little endian byte ordering.

Abbreviation	Bytes	Also known as
u8	1	unsigned char, unsigned byte, uint8_t
s8	1	char, byte, int8_t
u16	2	unsigned short, uint16_t
s16	2	short, int16_t
u32	4	unsigned int, unsigned long, uint32_t
s32	4	int, long, int32_t
u64	8	unsigned long long, uint64_t
s64	8	long long, int64_t
fp32	4	float
fp64	8	double

Table 44: Data Type Abbreviations used in the ANPP

11.3 System Packets

11.3.1 Acknowledge Packet

Acknowledgement Packet				
Packet ID		0		
Length		4		
Read / Write		Read		
Field #	Bytes Offset	Data Type	Size	Description
1	0	u8	1	Packet ID being acknowledged
2	1	u16	2	CRC of packet being acknowledged
3	3	u8	1	11.3.1.1 Acknowledge Result

Table 45: Acknowledge Packet

11.3.1.1 Acknowledge Result

Value	Description
0	Acknowledge success
1	Acknowledge failure, CRC error
2	Acknowledge failure, packet size incorrect
3	Acknowledge failure, values outside of valid ranges
4	Acknowledge failure, system flash memory failure
5	Acknowledge failure, system not ready
6	Acknowledge failure, unknown packet

Table 46: Acknowledge Result

11.3.2 Request Packet

Request Packet				
Packet ID		1		
Length		1 x number of packets requested		
Read / Write		Write		
Field #	Bytes Offset	Data Type	Size	Description
1	0	u8	1	Packet ID requested
+				Field 1 repeats for additional packet requests

Table 47: Request Packet

11.3.3 Boot Mode Packet

Boot Mode Packet				
Packet ID		2		
Length		1		
Read / Write		Read / Write		
Field #	Bytes Offset	Data Type	Size	Description
1	0	u8	1	11.3.3.1 Boot Mode Types

Table 48: Boot Mode Packet

11.3.3.1 Boot Mode Types

Value	Description
0	Bootloader
1	Main Program

Table 49: Boot Mode Types

11.3.4 Device Information Packet

Device Information Packet				
Packet ID		3		
Length		24		
Read / Write		Read		
Field #	Bytes Offset	Data Type	Size	Description
1	0	u32	4	Software version
2	4	u32	4	11.3.4.1 Device ID
3	8	u32	4	Hardware revision
4	12	u32	4	Certus Serial number part 1
5	16	u32	4	Certus Serial number part 2
6	20	u32	4	Certus Serial number part 3

Table 50: Device Information Packet

11.3.4.1 Device ID

Value	Description
1	Spatial
4	Spatial FOG
5	Spatial Dual
11	Orientus (>v3)
13	Air Data Unit
14	Subsonus
16	Spatial FOG Dual
17	Motus
19	GNSS Compass
21	Subsonus Tag
22	Poseidon
26	Certus
27	Aries
28	Boreas D90
41	Boreas D70

Table 51: Device IDs

11.3.5 Restore Factory Settings Packet

Note: A Factory Reset will re-enable the DHCP Client and lose any static IP address settings.

Restore Factory Settings Packet				
Packet ID		4		
Length		4		
Read / Write		Write		
Field #	Bytes Offset	Data Type	Size	Description
1	0	u32	4	Verification sequence (set to 0x85429E1C)

Table 52: Restore Factory Settings Packet

11.3.6 Reset Packet

Reset Packet				
Packet ID		5		
Length		4		
Read / Write		Write		
Field #	Bytes Offset	Data Type	Size	Description
1	0	u32	4	11.3.6.1 Verification Sequence Values

Table 53: Reset Packet

11.3.6.1 Verification Sequence Values

Value	Description
0x21057A7E	Standard hot start reset
0x9A5D38B7	Cold start reset

Table 54: Verification Sequence Values

11.3.7 Serial Port Passthrough Packet

Serial Port Passthrough Packet				
Packet ID		10		
Length		Variable, up to 255 bytes		
Read / Write		Read / Write		
Field #	Bytes Offset	Data Type	Size	Description
1	0	u8	1	Passthrough Route
2	1			Passthrough Data

Table 55: Serial Port Passthrough Packet

11.3.7.1 Passthrough Route

Value	Description
1	GPIO 1 and 2
2	Auxiliary

Table 56: Passthrough Route

11.3.8 IP Configuration Packet

IP Configuration Packet				
Packet ID		11		
Length		30		
Read / Write		Read / Write		
Field #	Bytes Offset	Data Type	Size	Description
1	0	u8	1	Permanent
2	1	u8	1	11.3.8.1 DHCP Mode
3	2	u32	4	IP Address
4	6	u32	4	IP Netmask
5	10	u32	4	IP Gateway
6	14	u32	4	DNS Server
7	18	u32	4	Certus Serial number part 1
8	22	u32	4	Certus Serial number part 2
9	26	u32	4	Certus Serial number part 3

Table 57: IP Configuration Packet

11.3.8.1 DHCP Mode

Bit	Description
0	DHCP Enabled
1	Automatic DNS
2-4	Link Mode. See 11.3.8.2 Link Mode Index
5-7	Reserved (set to zero)

Table 58: DHCP Mode

11.3.8.2 Link Mode Index

Value	Bit 4	Bit 3	Bit 2	Description
0	0	0	0	Auto

Table 59: Link Mode Index

11.3.8.3 Discovery Network Setting Overwrite

Settings 7,8 and 9 are optional over standard network interfaces but required to overwrite settings over multi-cast discovery. To overwrite network settings for a device over multi-cast send this packet to address 239.48.81.7 port 48817, the serial number must be set to the serial number of the device you want to overwrite settings for.

11.3.9 Extended Device Information Packet

Extended Device Information Packet				
Packet ID		13		
Length		36		
Read / Write		Read		
Field #	Bytes Offset	Data Type	Size	Description
1	0	u32	4	Software version
2	4	u32	4	11.3.4.1 Device ID
3	8	u32	4	Hardware Revision
4	12	u32[3]	12	Serial Number
5	24	u32	4	11.3.9.1 Device Sub-type
6	28	u8[8]	8	Reserved

Table 60: Extended Device Information Packet

11.3.9.1 Device Sub-type

Device ID	Device Sub-type Value	Description
26 - Certus	0	Certus
	1	Certus Evo
	2	Certus OEM
	3	Certus Evo OEM

Table 61: Device Sub-type's

11.3.10 Subcomponent Information Packet

Only Advanced Navigation sub-components will be shown here, for GNSS Receiver see [11.4.42 GNSS Receiver Information Packet](#)

Subcomponent Information Packet				
Packet ID		14		
Length		24 x number of subcomponents		
Read / Write		Read		
Field #	Bytes Offset	Data Type	Size	Description
1	0	u32	4	Subcomponent Software version
2	4	u32	4	11.3.10.1 Subcomponent Device ID
3	8	u32	4	Subcomponent Hardware Revision
4	12	u32[3]	12	Subcomponent Serial Number
Fields 1-4 repeat for additional subcomponents				

Table 62: Subcomponent Information Packet

11.3.10.1 Subcomponent Device ID

Value	Description
5	Spatial MEMS IMU
17	Evo MEMS IMU
27	Aries

Table 63: Subcomponent Device IDs

11.4 State Packets

Certus supports a ANPP number of packets providing extensive functionality. However for the majority of users the easiest approach is to configure Certus using the web UI or Certus Manager software and then support only the single system state packet shown in [11.4.1 System State Packet](#). Advanced functionality can be added as required through the other packets.

This section covers the following topics:

Packet ID	Name	Length	R/W
State Packets			
20	11.4.1 System State Packet	100	R
21	11.4.2 Unix Time Packet	8	R
22	11.4.3 Formatted Time Packet	14	R
23	11.4.4 Status Packet	4	R
24	11.4.5 Position Standard Deviation Packet	12	R
25	11.4.6 Velocity Standard Deviation Packet	12	R
26	11.4.7 Euler Orientation Standard Deviation Packet	12	R
27	11.4.8 Quaternion Orientation Standard Deviation Packet	16	R
28	11.4.9 Raw Sensors Packet	48	R
29	11.4.10 Raw GNSS Packet	74	R/W
30	11.4.11 Satellites Packet	13	R
32	11.4.12 Geodetic Position Packet	24	R
33	11.4.13 ECEF Position Packet	24	R
34	11.4.14 UTM Position Packet	26	R
35	11.4.15 NED Velocity Packet	12	R
36	11.4.16 Body Velocity Packet	12	R
37	11.4.17 Acceleration Packet	12	R
38	11.4.18 Body Acceleration Packet	16	R
39	11.4.19 Euler Orientation Packet	12	R
40	11.4.20 Quaternion Orientation Packet	16	R
41	11.4.21 DCM Orientation Packet	36	R
42	11.4.22 Angular Velocity Packet	12	R
43	11.4.23 Angular Acceleration Packet	12	R
44	11.4.24 External Position and Velocity Packet	60	R/W
45	11.4.25 External Position Packet	36	R/W

Packet ID	Name	Length	R/W
46	11.4.26 External Velocity Packet	24	R/W
47	11.4.27 External Body Velocity Packet	16 or 24	R/W
48	11.4.28 External Heading Packet	8	R/W
49	11.4.29 Running Time Packet	8	R
50	11.4.30 Local Magnetic Field Packet	12	R
51	11.4.31 Odometer State Packet	20	R
52	11.4.32 External Time Packet	8	W
53	11.4.33 External Depth Packet	8	R/W
54	11.4.34 Geoid Height Packet	4	R
55	11.4.35 RTCM Corrections Packet	Varies	W
57	11.4.36 Wind Packet	12	R/W
58	11.4.37 Heave Packet	16	R
60	11.4.38 Raw Satellite Data Packet	Varies	R
61	11.4.39 Raw Satellite Ephemeris Packet	Varies	R
67	11.4.40 External Odometer Packet	13	W
68	11.4.41 External Air Data Packet	25	R/W
69	11.4.42 GNSS Receiver Information Packet	Varies	R
70	11.4.43 Raw DVL Data Packet	60	R/W
72	11.4.44 Gimbal State Packet	8	R/W
73	11.4.45 Automotive Packet	24	R
75	11.4.46 External Magnetometers Packet	17	R/W
80	11.4.47 Basestation Packet	45	R
83	11.4.48 Zero Angular Velocity Packet	8	W
84	11.4.49 Extended Satellites Packet	Varies	R
85	11.4.50 Sensor Temperature Packet	32	R

Table 64: State Packets

11.4.1 System State Packet

System State Packet				
Packet ID				20
Length				100
Read / Write				Read
Field #	Bytes Offset	Data Type	Size	Description
1	0	u16	2	11.4.1.1 System Status
2	2	u16	2	11.4.1.2 Filter Status
3	4	u32	4	11.4.1.4 Unix Time Seconds
4	8	u32	4	11.4.1.5 Microseconds
5	12	fp64	8	Latitude (rad)
6	20	fp64	8	Longitude (rad)
7	28	fp64	8	Height (m)
8	36	fp32	4	Velocity north (m/s)
9	40	fp32	4	Velocity east (m/s)
10	44	fp32	4	Velocity down (m/s)
11	48	fp32	4	Body acceleration X (m/s/s)
12	52	fp32	4	Body acceleration Y (m/s/s)
13	56	fp32	4	Body acceleration Z (m/s/s)
14	60	fp32	4	G force (g)
15	64	fp32	4	Roll (radians)
16	68	fp32	4	Pitch (radians)
17	72	fp32	4	Heading (radians)
18	76	fp32	4	Angular velocity X (rad/s)
19	80	fp32	4	Angular velocity Y (rad/s)
20	84	fp32	4	Angular velocity Z (rad/s)
21	88	fp32	4	Latitude standard deviation (m)
22	92	fp32	4	Longitude standard deviation (m)
23	96	fp32	4	Height standard deviation (m)

Table 65: System State Packet

11.4.1.1 System Status

This field contains 16 bits that indicate problems with the system. These are boolean fields with a zero indicating false and one indicating true.

Use the Raw GNSS packet #29 to identify which of the GNSS receivers or antennas has a problem.

Bit	Description
0	System Failure
1	Accelerometer Sensor Failure
2	Gyroscope Sensor Failure
3	Magnetometer Sensor Failure
4	Pressure Sensor Failure
5	GNSS Failure
6	Accelerometer Over Range
7	Gyroscope Over Range
8	Magnetometer Over Range
9	Pressure Over Range
10	Minimum Temperature Alarm
11	Maximum Temperature Alarm
12	Internal Data Logging Error
13	High Voltage Alarm
14	GNSS Antenna Connection (open or short circuit, primary or secondary antenna). NOTE: This bit is not applicable to units with a Trimble BD992 GNSS Receiver
15	Data Output Overflow Alarm

Table 66: System Status

11.4.1.2 Filter Status

This field contains 16 bits that indicate the status of the filters. These are boolean fields with a zero indicating false and one indicating true.

Bit	Description
0	Orientation Filter Initialised
1	Navigation Filter Initialised
2	Heading Initialised
3	UTC Time Initialised
4	11.4.1.3 GNSS Fix Status
5	
6	
7	Event 1 Occurred
8	Event 2 Occurred
9	Internal GNSS Enabled
10	Dual Antenna Heading Active
11	Velocity Heading Enabled
12	Atmospheric Altitude Enabled
13	External Position Active
14	External Velocity Active
15	External Heading Active

Table 67: Filter Status

11.4.1.3 GNSS Fix Status

Value	Bit 6	Bit 5	Bit 4	Description
0	0	0	0	No GNSS fix
1	0	0	1	2D GNSS fix
2	0	1	0	3D GNSS fix
3	0	1	1	SBAS GNSS fix
4	1	0	0	Differential GNSS fix
5	1	0	1	PPP GNSS fix
6	1	1	0	RTK Float GNSS fix
7	1	1	1	RTK Fixed GNSS fix

Table 68: GNSS Fix Status

11.4.1.4 Unix Time Seconds

This field provides the Unix time in seconds, using the standard epoch of January 1, 1970.

11.4.1.5 Microseconds

This field provides the sub-second component of time. It is represented as microseconds since the last second. Minimum value is 0 and maximum value is 999999.

11.4.2 Unix Time Packet

Unix Time Packet				
Packet ID		21		
Length		8		
Read / Write		Read		
Field #	Bytes Offset	Data Type	Size	Description
1	0	u32	4	Unix time stamp (seconds). See 11.4.1.4 Unix Time Seconds
2	4	u32	4	Microseconds

Table 69: Unix Time Packet

11.4.3 Formatted Time Packet

Formatted Time Packet				
Packet ID		22		
Length		14		
Read / Write		Read		
Field #	Bytes Offset	Data Type	Size	Description
1	0	u32	4	Microseconds
2	4	u16	2	Year
3	6	u16	2	Year day, 0 - 365
4	8	u8	1	Month, 0 - 11
5	9	u8	1	Month Day, 1 - 31
6	10	u8	1	Week Day, 0 – 6 (0 = Sunday)
7	11	u8	1	Hour, 0 - 23
8	12	u8	1	Minute, 0 - 59
9	13	u8	1	Second, 0 - 59

Table 70: Formatted Time Packet

11.4.4 Status Packet

Status Packet				
Packet ID		23		
Length		4		
Read / Write		Read		
Field #	Bytes Offset	Data Type	Size	Description
1	0	u16	2	System Status
2	2	u16	2	Filter Status

Table 71: Status Packet

11.4.5 Position Standard Deviation Packet

Position Standard Deviation Packet				
Packet ID		24		
Length		12		
Read / Write		Read		
Field #	Bytes Offset	Data Type	Size	Description
1	0	fp32	4	Latitude standard deviation (m)
2	4	fp32	4	Longitude standard deviation (m)
3	8	fp32	4	Height standard deviation (m)

Table 72: Position Standard Deviation Packet

11.4.6 Velocity Standard Deviation Packet

Velocity Standard Deviation Packet				
Packet ID		25		
Length		12		
Read / Write		Read		
Field #	Bytes Offset	Data Type	Size	Description
1	0	fp32	4	Velocity north standard deviation (m/s)
2	4	fp32	4	Velocity east standard deviation (m/s)
3	8	fp32	4	Velocity down standard deviation (m/s)

Table 73: Velocity Standard Deviation Packet

11.4.7 Euler Orientation Standard Deviation Packet

Euler Orientation Standard Deviation Packet				
Packet ID		26		
Length		12		
Read / Write		Read		
Field #	Bytes Offset	Data Type	Size	Description
1	0	fp32	4	Roll standard deviation (rad)
2	4	fp32	4	Pitch standard deviation(rad)
3	8	fp32	4	Heading standard deviation(rad)

Table 74: Euler Orientation Standard Deviation Packet

11.4.8 Quaternion Orientation Standard Deviation Packet

Quaternion Orientation Standard Deviation Packet				
Packet ID		27		
Length		16		
Read / Write		Read		
Field #	Bytes Offset	Data Type	Size	Description
1	0	fp32	4	Q0 standard deviation
2	4	fp32	4	Q1 standard deviation
3	8	fp32	4	Q2 standard deviation
4	12	fp32	4	Q3 standard deviation

Table 75: Quaternion Orientation Standard Deviation Packet

11.4.9 Raw Sensors Packet

Raw Sensors Packet				
Packet ID				28
Length				48
Read / Write				Read
Field #	Bytes Offset	Data Type	Size	Description
1	0	fp32	4	Accelerometer X (m/s/s)
2	4	fp32	4	Accelerometer Y (m/s/s)
3	8	fp32	4	Accelerometer Z (m/s/s)
4	12	fp32	4	Gyroscope X (rad/s)
5	16	fp32	4	Gyroscope Y (rad/s)
6	20	fp32	4	Gyroscope Z (rad/s)
7	24	fp32	4	Magnetometer X (mG)
8	28	fp32	4	Magnetometer Y (mG)
9	32	fp32	4	Magnetometer Z (mG)
10	36	fp32	4	IMU Temperature (deg C)
11	40	fp32	4	Pressure (Pascals)
12	44	fp32	4	Pressure Temperature (deg C)

Table 76: Raw Sensors Packet

11.4.10 Raw GNSS Packet

This packet represents the raw data as it is received from the GNSS receiver. The position is not corrected for antenna position offset and the velocity is not compensated for the antenna lever arm offset. The INS position and velocity that are in the other packets are corrected for antenna position offset and lever arm.

Raw GNSS Packet				
Packet ID		29		
Length		74		
Read / Write		Read		
Field #	Bytes Offset	Data Type	Size	Description
1	0	u32	4	Unix time stamp (seconds)
2	4	u32	4	Microseconds
3	8	fp64	8	Latitude (rad)
4	16	fp64	8	Longitude (rad)
5	24	fp64	8	Height (m)
6	32	fp32	4	Velocity north (m/s)
7	36	fp32	4	Velocity east (m/s)
8	40	fp32	4	Velocity down (m/s)
9	44	fp32	4	Latitude standard deviation (m)
10	48	fp32	4	Longitude standard deviation (m)
11	52	fp32	4	Height standard deviation (m)
12	56	fp32	4	Tilt (rad)
13	60	fp32	4	Heading (rad)
14	64	fp32	4	Tilt standard deviation (rad)
15	68	fp32	4	Heading standard deviation (rad)
16	72	u16	2	Status. See 11.4.10.1 Raw GNSS Status

Table 77: Raw GNSS Packet

11.4.10.1 Raw GNSS Status

Bit	Description
0	GNSS Fix Status
1	
2	
3	Doppler velocity valid
4	Time valid
5	External GNSS

Bit	Description
6	Tilt valid
7	Heading valid
8	Floating ambiguity heading
9	Reserved (set to zero)
10	Antenna 1 disconnected (not applicable to units with Trimble BD992 GNSS receiver)
11	Antenna 2 disconnected (not applicable to units with Trimble BD992 GNSS receiver)
12	Antenna 1 short (not applicable to units with Trimble BD992 GNSS receiver)
13	Antenna 2 short (not applicable to units with Trimble BD992 GNSS receiver)
14	GNSS1 failure
15	GNSS2 failure (not applicable to units with Trimble BD992 GNSS receiver)

Table 78: Raw GNSS Status

11.4.11 Satellites Packet

Satellites Packet				
Packet ID		30		
Length		13		
Read / Write		Read		
Field #	Bytes Offset	Data Type	Size	Description
1	0	fp32	4	HDOP
2	4	fp32	4	VDOP
3	8	u8	1	GPS satellites
4	9	u8	1	GLONASS satellites
5	10	u8	1	BeiDou satellites
6	11	u8	1	GALILEO satellites
7	12	u8	1	SBAS satellites

Table 79: Satellites Packet

11.4.12 Geodetic Position Packet

Geodetic Position Packet				
Packet ID		32		
Length		24		
Read / Write		Read		
Field #	Bytes Offset	Data Type	Size	Description
1	0	fp64	8	Latitude (rad)
2	8	fp64	8	Longitude (rad)
3	16	fp64	8	Height (m)

Table 80: Geodetic Position Packet

11.4.13 ECEF Position Packet

ECEF Position Packet				
Packet ID		33		
Length		24		
Read / Write		Read		
Field #	Bytes Offset	Data Type	Size	Description
1	0	fp64	8	ECEF X (m)
2	8	fp64	8	ECEF Y (m)
3	16	fp64	8	ECEF Z (m)

Table 81: ECEF Position Packet

11.4.14 UTM Position Packet

UTM Position Packet				
Packet ID		34		
Length		26		
Read / Write		Read		
Field #	Bytes Offset	Data Type	Size	Description
1	0	fp64	8	Northing (m)
2	8	fp64	8	Easting (m)
3	16	fp64	8	Height (m)
4	24	u8	1	Zone number
5	25	s8	1	Zone character

Table 82: UTM Position Packet

11.4.15 NED Velocity Packet

NED Velocity Packet				
Packet ID		35		
Length		12		
Read / Write		Read		
Field #	Bytes Offset	Data Type	Size	Description
1	0	fp32	4	Velocity north (m/s)
2	4	fp32	4	Velocity east (m/s)
3	8	fp32	4	Velocity down (m/s)

Table 83: NED Velocity Packet

11.4.16 Body Velocity Packet

Body Velocity Packet				
Packet ID		36		
Length		12		
Read / Write		Read		
Field #	Bytes Offset	Data Type	Size	Description
1	0	fp32	4	Velocity X (m/s)
2	4	fp32	4	Velocity Y (m/s)
3	8	fp32	4	Velocity Z (m/s)

Table 84: Body Velocity Packet

11.4.17 Acceleration Packet

This packet includes the acceleration due to gravity.

Acceleration Packet				
Packet ID		37		
Length		12		
Read / Write		Read		
Field #	Bytes Offset	Data Type	Size	Description
1	0	fp32	4	Acceleration X (m/s/s)
2	4	fp32	4	Acceleration Y (m/s/s)
3	8	fp32	4	Acceleration Z (m/s/s)

Table 85: Acceleration Packet

11.4.18 Body Acceleration Packet

This packet does not include the acceleration due to gravity.

Body Acceleration Packet				
Packet ID		38		
Length		16		
Read / Write		Read		
Field #	Bytes Offset	Data Type	Size	Description
1	0	fp32	4	Body acceleration X (m/s/s)
2	4	fp32	4	Body acceleration Y (m/s/s)
3	8	fp32	4	Body acceleration Z (m/s/s)
4	12	fp32	4	G force (g)

Table 86: Body Acceleration Packet

11.4.19 Euler Orientation Packet

Euler Orientation Packet				
Packet ID		39		
Length		12		
Read / Write		Read		
Field #	Bytes Offset	Data Type	Size	Description
1	0	fp32	4	Roll (rad)
2	4	fp32	4	Pitch (rad)
3	8	fp32	4	Heading (rad)

Table 87: Euler Orientation Packet

11.4.20 Quaternion Orientation Packet

Quaternion Orientation Packet				
Packet ID		40		
Length		16		
Read / Write		Read		
Field #	Bytes Offset	Data Type	Size	Description
1	0	fp32	4	QS
2	4	fp32	4	QX
3	8	fp32	4	QY
4	12	fp32	4	QZ

Table 88: Quaternion Orientation Packet

11.4.21 DCM Orientation Packet

DCM Orientation Packet				
Packet ID				41
Length				36
Read / Write				Read
Field #	Bytes Offset	Data Type	Size	Description
1	0	fp32	4	DCM[0][0]
2	4	fp32	4	DCM[0][1]
3	8	fp32	4	DCM[0][2]
4	12	fp32	4	DCM[1][0]
5	16	fp32	4	DCM[1][1]
6	20	fp32	4	DCM[1][2]
7	24	fp32	4	DCM[2][0]
8	28	fp32	4	DCM[2][1]
9	32	fp32	4	DCM[2][2]

Table 89: DCM Orientation Packet

11.4.22 Angular Velocity Packet

Angular Velocity Packet				
Packet ID				42
Length				12
Read / Write				Read
Field #	Bytes Offset	Data Type	Size	Description
1	0	fp32	4	Angular velocity X (rad/s)
2	4	fp32	4	Angular velocity Y (rad/s)
3	8	fp32	4	Angular velocity Z (rad/s)

Table 90: Angular Velocity Packet

11.4.23 Angular Acceleration Packet

Angular Acceleration Packet				
Packet ID		43		
Length		12		
Read / Write		Read		
Field #	Bytes Offset	Data Type	Size	Description
1	0	fp32	4	Angular acceleration X (rad/s/s)
2	4	fp32	4	Angular acceleration Y (rad/s/s)
3	8	fp32	4	Angular acceleration Z (rad/s/s)

Table 91: Angular Acceleration Packet

11.4.24 External Position and Velocity Packet

External Position and Velocity Packet				
Packet ID		44		
Length		60		
Read / Write		Read / Write		
Field #	Bytes Offset	Data Type	Size	Description
1	0	fp64	8	Latitude (rad)
2	8	fp64	8	Longitude (rad)
3	16	fp64	8	Height (m)
4	24	fp32	4	Velocity north (m/s)
5	28	fp32	4	Velocity east (m/s)
6	32	fp32	4	Velocity down (m/s)
7	36	fp32	4	Latitude standard deviation (m)
8	40	fp32	4	Longitude standard deviation (m)
9	44	fp32	4	Height standard deviation (m)
10	48	fp32	4	Velocity north standard deviation (m/s)
11	52	fp32	4	Velocity east standard deviation (m/s)
12	56	fp32	4	Velocity down standard deviation (m/s)

Table 92: External Position and Velocity Packet

11.4.25 External Position Packet

External Position Packet				
Packet ID				45
Length				36
Read / Write				Read / Write
Field #	Bytes Offset	Data Type	Size	Description
1	0	fp64	8	Latitude (rad)
2	8	fp64	8	Longitude (rad)
3	16	fp64	8	Height (m)
4	24	fp32	4	Latitude standard deviation (m) Must be non-zero positive value
5	28	fp32	4	Longitude standard deviation (m) Must be non-zero positive value
6	32	fp32	4	Height standard deviation (m) Must be non-zero positive value

Table 93: External Position Packet

11.4.26 External Velocity Packet

External Velocity Packet				
Packet ID				46
Length				24
Read / Write				Read / Write
Field #	Bytes Offset	Data Type	Size	Description
1	0	fp32	4	Velocity north (m/s)
2	4	fp32	4	Velocity east (m/s)
3	8	fp32	4	Velocity down (m/s)
4	12	fp32	4	Velocity north standard deviation (m/s)
5	16	fp32	4	Velocity east standard deviation (m/s)
6	20	fp32	4	Velocity down standard deviation (m/s)

Table 94: External Velocity Packet

11.4.27 External Body Velocity Packet

This packet has been defined to support a single velocity standard deviation for all three axes, or, different values for all three axes. Modify the packet length in the packet header accordingly, depending on which format you are using.

External Body Velocity Packet				
Packet ID		47		
Length		16 or 24		
Read / Write		Read / Write		
Field #	Bytes Offset	Data Type	Size	Description
1	0	fp32	4	Velocity X (m/s)
2	4	fp32	4	Velocity Y (m/s)
3	8	fp32	4	Velocity Z (m/s)
4	12	fp32	4	Velocity X standard deviation (m/s)
5	16	fp32	4	OPTIONAL: Velocity standard deviation Y (m/s)
6	20	fp32	4	OPTIONAL: Velocity standard deviation Z (m/s)

Table 95: External Body Velocity Packet

11.4.28 External Heading Packet

External Heading Packet				
Packet ID		48		
Length		8		
Read / Write		Read / Write		
Field #	Bytes Offset	Data Type	Size	Description
1	0	fp32	4	Heading (rad)
2	4	fp32	4	Heading standard deviation (rad)

Table 96: External Heading Packet

11.4.29 Running Time Packet

This packet provides the running time in seconds since the most recent power on.

Running Time Packet				
Packet ID		49		
Length		8		
Read / Write		Read		
Field #	Bytes Offset	Data Type	Size	Description
1	0	u32	4	Running time (seconds)
2	4	u32	4	11.4.1.5 Microseconds

Table 97: Running Time Packet

11.4.30 Local Magnetic Field Packet

Local Magnetic Field Packet				
Packet ID		50		
Length		12		
Read / Write		Read		
Field #	Bytes Offset	Data Type	Size	Description
1	0	fp32	4	Local magnetic field X (mG)
2	4	fp32	4	Local magnetic field Y (mG)
3	8	fp32	4	Local magnetic field Z (mG)

Table 98: Local Magnetic Field Packet

11.4.31 Odometer State Packet

Odometer State Packet				
Packet ID		51		
Length		20		
Read / Write		Read		
Field #	Bytes Offset	Data Type	Size	Description
1	0	s32	4	Odometer pulse count
2	4	fp32	4	Odometer distance (m)
3	8	fp32	4	Odometer speed (m/s)
4	12	fp32	4	Odometer slip (m)
5	16	u8	1	Odometer active
6	17		3	Reserved

Table 99: Odometer State Packet

11.4.32 External Time Packet

External Time Packet				
Packet ID		52		
Length		8		
Read / Write		Write		
Field #	Bytes Offset	Data Type	Size	Description
1	0	u32	4	11.4.1.4 Unix Time Seconds
2	4	u32	4	11.4.1.5 Microseconds

Table 100: External Time Packet

11.4.33 External Depth Packet

External Depth is the measured distance below Mean Sea Level

External Depth Packet				
Packet ID		53		
Length		8		
Read / Write		Read / Write		
Field #	Bytes Offset	Data Type	Size	Description
1	0	fp32	4	Depth (m)
2	4	fp32	4	Depth standard deviation (m)

Table 101: External Depth Packet

11.4.34 Geoid Height Packet

This packet provides the offset at the current location between the WGS84 ellipsoid and the EGM96 geoid model. This can be used to determine the current height above mean sea level and also depth through the following equations:

Height Above Mean Sea Level = WGS84 Height – Geoid Height

Depth = Geoid Height – WGS84 Height

WGS84 Height is the height at the current location in the System State packet, see [11.4.1 System State Packet](#)

Geoid Height Packet				
Packet ID		54		
Length		4		
Read / Write		Read		
Field #	Bytes Offset	Data Type	Size	Description
1	0	fp32	4	Geoid height (m)

Table 102: Geoid Height Packet

11.4.35 RTCM Corrections Packet

This packet is used to encapsulate RTCM v3 correction data to be sent to the Certus internal GNSS receiver for DGPS or RTK GNSS functionality.

RTCM Corrections Packet				
Packet ID		55		
Length		Variable, up to 255 bytes		
Read / Write		Write		
Field #	Bytes Offset	Data Type	Size	Description
1	0			RTCM corrections data

Table 103: RTCM Corrections Packet

11.4.36 Wind Packet

This packet provides the Certus current 2D wind velocity. These values are only valid when external air data is provided to Certus. This can be either through the [11.4.41 External Air Data Packet](#) or when a pitot tube is interfaced to one of the GPIO pins. When this packet is written to the device, it disables the wind estimation filter and the wind values provided are used statically.

Wind Packet				
Packet ID		57		
Length		12		
Read / Write		Read / Write		
Field #	Bytes Offset	Data Type	Size	Description
1	0	fp32	4	Wind velocity north (m/s)
2	4	fp32	4	Wind velocity east (m/s)
3	8	fp32	4	Wind velocity standard deviation (m/s)

Table 104: Wind Packet

11.4.37 Heave Packet

Heave Packet				
Packet ID		58		
Length		16		
Read / Write		Read		
Field #	Bytes Offset	Data Type	Size	Description
1	0	fp32	4	Heave point 1 (m)
2	4	fp32	4	Heave point 2 (m)
3	8	fp32	4	Heave point 3 (m)
4	12	fp32	4	Heave point 4 (m)

Table 105: Heave Packet

11.4.38 Raw Satellite Data Packet

The Certus Manager Log Converter will automatically convert this packet to RINEX 3.02 format.

Note: Once this packet is enabled, Packet 61 ([11.4.39 Raw Satellite Ephemeris Packet](#)) will also be enabled automatically.

Raw Satellite Data Packet	
Packet ID	60
Length	16 + Satellites * (6 + Frequencies * 26)
Read / Write	Read

Raw Satellite Data Packet				
Field #	Bytes Offset	Data Type	Size	Description
1	0	u32	4	Unix time (seconds)
2	4	u32	4	Nanoseconds
3	8	s32	4	Receiver clock offset (nanoseconds)
4	12	u8	1	Receiver number
5	13	u8	1	Packet number (range 1 to Total)
6	14	u8	1	Total packets
7	15	u8	1	Number of satellites
For each satellite				
8	16	u8	1	Satellite Systems
9	17	u8	1	PRN or satellite number
10	18	u8	1	Elevation (degrees)
11	19	u16	2	Azimuth (degrees)
12	21	u8	1	Number of frequencies
For each frequency of each satellite				
13	22	u8	1	Satellite Frequencies
14	23	u8	1	Tracking Status
15	24	fp64	8	Carrier phase (cycles)
16	32	fp64	8	Pseudo range (m)
17	40	fp32	4	Doppler frequency (Hz)
18	44	fp32	4	Signal to noise ratio (dB-Hz)

Table 106: Raw Satellite Data Packet

11.4.38.1 Satellite Systems

Value	System
0	Unknown
1	GPS
2	GLONASS
3	BeiDou
4	Galileo
5	SBAS
6	QZSS
7	Reserved

Value	System
8	Reserved
9	Reserved

Table 107: Satellite Systems

11.4.38.2 Satellite Frequencies

Value	GPS	GLONASS	Galileo	BeiDou	SBAS	QZSS
0	Unknown	Unknown	Unknown	Unknown	Unknown	Unknown
1	L1 C/A	G1 C/A	E1 OS	B1	L1 C/A	L1 C/A
2	L1 C		E1 PRS			L1 C
3	L1 P	G1 P				L1 SAIF
4	L1 M					
5	L2 C	G2 C/A	E6 CS	B2		L2 C
6	L2 P	G2 P	E6 PRS			LEX
7	L2 M					
8	L5	G3	E5 a	B3	L5	L5
9			E5 b			
10			E5 a+b			

Table 108: Satellite Frequencies

11.4.38.3 Tracking Status

Bit	Description
0	Carrier phase valid
1	Carrier phase cycle slip detected
2	Carrier phase half-cycle ambiguity
3	Pseudo range valid
4	Doppler valid
5	SNR valid
6-7	Reserved (set to zero)

Table 109: Tracking Status

11.4.39 Raw Satellite Ephemeris Packet

Certus Manager will automatically convert this packet to RINEX 3.02 format.

Note: This packet is enabled automatically when packet 60 ([11.4.38 Raw Satellite Data Packet](#)) is enabled. This packet cannot be enabled independently of Packet 60.

Raw Satellite Ephemeris Packet				
Packet ID		61		
Length		Varies		
Read / Write		Read		
Field #	Bytes Offset	Data Type	Size	Description
1	0	u32	4	Unix timestamp (seconds)
2	4	u8	1	Satellite System
3	5	u8	1	Satellite number (PRN)
For GPS Satellites (132 bytes)				
5	6	u32	4	Time of ephemeris (Toe) (s)
6	10	u16	2	Issue of Data Clock [IODC] (s)
7	12	u16	2	Issue of Data Ephemeris [IODE] (s)
8	14	fp32	4	Satellite Clock Bias [af0] (s)
9	18	fp32	4	Satellite Clock Drift [af1] (s/s)
10	22	fp32	4	Satellite Clock Drift Rate [af2] (s/s/s)
11	26	fp32	4	Crs (m)
12	30	fp32	4	Delta N (rad/s)
13	34	fp64	8	M0 (rad)
14	42	fp32	4	Cuc (rad)
15	46	fp64	8	Eccentricity [e]
16	54	fp32	4	Cus (rad)
17	58	fp64	8	\sqrt{A} (\sqrt{m})
18	66	fp32	4	Cic (rad)
19	70	fp64	8	OMEGA0 (rad)
20	78	fp32	4	Cis (rad)
21	82	fp64	8	i0 (rad)
22	90	fp32	4	Crc (m)
23	94	fp64	8	Omega (rad)
24	102	fp64	8	Omega dot (rad/s)
25	110	fp64	8	IDOT (rad/s)
26	118	fp32	4	TGD (s)
27	122	u16	2	Ephemeris week number
28	124	u32	4	Transmission time (s)
29	128	u16	2	User range accuracy (m)
30	130	u16	2	11.4.39.1 GPS Flags

Raw Satellite Ephemeris Packet				
For GLONASS satellites (94 Bytes)				
5	6	fp32	4	Satellite clock bias (s)
6	10	fp32	4	Satellite frequency bias [gamma]
7	14	fp64	8	Satellite position X (m)
8	22	fp64	8	Satellite position Y (m)
9	30	fp64	8	Satellite position Z (m)
10	38	fp64	8	Satellite velocity X (m/s)
11	46	fp64	8	Satellite velocity Y (m/s)
12	54	fp64	8	Satellite velocity Z (m/s)
13	62	fp64	8	Satellite acceleration X (m/s/s)
14	70	fp64	8	Satellite acceleration Y (m/s/s)
15	78	fp64	8	Satellite acceleration Z (m/s/s)
16	86	u32	4	Message frame start time (s)
17	90	u8	1	Age of operational information [E] (days)
18	91	s8	1	Frequency slot number
19	92	u8	1	Satellite Health
20	93	u8	1	Reserved

Table 110: Raw Satellite Ephemeris Packet

11.4.39.1 GPS Flags

Bit	Description
0	Data flag for L2 P-code
1-2	Codes on L2 channel
3	Anti-spoof flag
4-9	Satellite health
10	Fit interval flag
11	URA bad
12-14	Satellite block type

Table 111: GPS Flags

11.4.40 External Odometer Packet

External Odometer Packet	
Packet ID	67
Length	13

External Odometer Packet				
Read / Write				Write
Field #	Bytes Offset	Data Type	Size	Description
1	0	fp32	4	Estimated delay (s)
2	4	fp32	4	Speed (m/s)
3	8	fp32	4	Reserved (set to zero)
4	12	u8	1	Odometer flags

Table 112: External Odometer Packet

11.4.40.1 Odometer Flags

Bit	Description
0	Reversing detection supported
1-7	Reserved (set to zero)

Table 113: Odometer Flags

11.4.41 External Air Data Packet

External Air Data Packet				
Packet ID			68	
Length			25	
Read / Write			Read / Write	
Field #	Bytes Offset	Data Type	Size	Description
1	0	fp32	4	Barometric altitude delay (s)
2	4	fp32	4	Airspeed delay (s)
2	8	fp32	4	Barometric altitude (m)
3	12	fp32	4	Airspeed (m/s)
4	16	fp32	4	Barometric altitude standard deviation (m)
5	20	fp32	4	Airspeed standard deviation (m/s)
6	24	u8	1	Flags

Table 114: External Air Data Packet

11.4.41.1 External Air Data Flags

Bit	Description
0	Barometric altitude set and valid
1	Airspeed set and valid
2	Barometric altitude reference reset

Table 115: External Air Data Flags

Barometric altitude does not need to be referenced to any co-ordinate frame or QNH. If the barometric altitude reference is changed during operation, the barometric altitude reference reset flag should be set for the next packet.

11.4.42 GNSS Receiver Information Packet

11.4.42.1 Aries GNSS Receiver

Aries GNSS Receiver Information Packet				
Packet ID		69		
Length		68		
Read / Write		Read		
Field #	Bytes Offset	Data Type	Size	Description
1	0	u8	1	GNSS manufacturer ID
2	1	u8	1	GNSS receiver model
3	2	s8 [24]	24	GNSS serial number in ASCII character string
4	26	u32	4	Firmware version
5	30	u32	4	Hardware version
6	34		34	Reserved (set to zero)

Table 116: Aries GNSS Receiver Information Packet

11.4.42.2 Trimble BD992 GNSS Receiver

Trimble BD992 GNSS Receiver Information Packet				
Packet ID		69		
Length		48		
read/Write		Read		
Field #	Bytes Offset	Data Type	Size	Description
1	0	u8	1	GNSS manufacturer ID
2	1	u8	1	GNSS receiver model
3	2	s8[10]	10	GNSS serial number in ASCII character string
4	12	u32	4	Firmware version
5	16	u32[3]	12	Software license code
6	28	u32	4	Omnistar serial number
7	32	u32	4	Omnistar subscription start unix time
8	36	u32	4	Omnistar subscription expiry unix time
9	40	u8	1	Omnistar engine mode
10	41	u8	1	RTK Software license accuracy
11	42		6	Reserved (set to zero)

Table 117: Trimble BD992 GNSS Receiver Information Packet

11.4.42.3 GNSS Manufacturer IDs and Receiver Models

Manufacturer		Receiver	
ID	Description	Value	Description
0	GNSS Manufacturer Unknown	0	GNSS Receiver Model Unknown
1	Trimble	0	GNSS Receiver Model Unknown
		1	Trimble BD920
		2	Trimble BD930
		3	Trimble BD982
		4	Trimble MB-One
		5	Trimble MB-Two
		6	Trimble BD940
		7	Trimble BD992
3	Advanced Navigation	0	GNSS Receiver Model Unknown
		1	Aries
		2	Aries GC2

Table 118: GNSS Manufacturer IDs and Receiver Models

11.4.42.4 Omnistar Engine Modes

Value	Description
0	Omnistar engine not active
1	HP
2	XP
3	G2
4	HP+G2
5	HP+XP

Table 119: Omnistar Engine Modes

11.4.42.5 RTK Software License Accuracy

Value	Description
0	RTK accuracy unknown
1	0.3m horizontal, 0.3m vertical
2	0.1m horizontal, 0.1m vertical
3	0.1m horizontal, 0.02m vertical
4	0.008m horizontal, 0.1m vertical

Value	Description
5	0.008m horizontal, 0.02m vertical

Table 120: RTK Software License Accuracies

11.4.43 Raw DVL Data Packet

Note: The Raw DVL Data packet will be output each time it is received, unless a certain output rate has been set in "Configuration" → "Packet Rates" of Certus Manager.

Raw DVL Data Packet				
Packet ID		70		
Length		60		
Read / Write		Read / Write		
Field #	Bytes Offset	Data Type	Size	Description
1	0	u32	4	Unix timestamp (seconds)
2	4	u32	4	Microseconds
3	8	u32	4	Flags, see 11.4.43.1 Raw DVL Data Flags
4	12	fp32	4	Bottom velocity X (m/s)
5	16	fp32	4	Bottom velocity Y (m/s)
6	20	fp32	4	Bottom velocity Z (m/s)
7	24	fp32	4	Bottom velocity standard deviation (m/s)
8	28	fp32	4	Water velocity X (m/s)
9	32	fp32	4	Water velocity Y (m/s)
10	36	fp32	4	Water velocity Z (m/s)
11	40	fp32	4	Water velocity standard deviation (m/s)
12	44	fp32	4	Water velocity layer depth (m)
13	48	fp32	4	Depth (m)
14	52	fp32	4	Altitude (m)
15	56	fp32	4	Temperature (deg C)

Table 121: Raw DVL Data Packet

11.4.43.1 Raw DVL Data Flags

Bit	Description
0	Bottom velocity valid
1	Water velocity valid
2	Temperature valid
3	Depth valid
4	Altitude valid

Table 122: Raw DVL Data Flags

11.4.44 Gimbal State Packet

Certus will accept (write) Current angle values between -2π and 2π exclusive.

Certus will output (read) values between $-\pi$ and π for current angle.

Gimbal State Packet				
Packet ID		72		
Length		8		
Read / Write		Read / Write		
Field #	Bytes Offset	Data Type	Size	Description
1	0	fp32	4	Current angle (rad)
2	4		4	Reserved (set to zero)

Table 123: Gimbal State Packet

11.4.45 Automotive Packet

The value of the slip angle will be zero unless velocity is greater than 3.45 m/s and heading is valid.

Automotive Packet				
Packet ID		73		
Length		24		
Read / Write		Read		
Field #	Bytes Offset	Data Type	Size	Description
1	0	fp32	4	Virtual odometer distance (m)
2	4	fp32	4	Slip Angle (rad) Value reported is zero, unless heading is valid and the velocity is greater than 3.45 m/s
3	8	fp32	4	Velocity X (m/s)
4	12	fp32	4	Velocity Y (m/s)
5	16	fp32	4	Distance standard deviation (m)
6	20		4	Reserved (set to zero)

Table 124: Automotive Packet

11.4.46 External Magnetometers Packet

Heading can be derived using the magnetometers of an additional external Advanced Navigation product to input external magnetometer values.

The 2D, 3D or automatic magnetic calibration of Certus cannot be used to calibrate the external magnetometer values. External magnetometers need to be calibrated before feeding into Certus.

To use External Magnetic Heading, disable Magnetic Heading Enabled and Automatic Magnetic Calibration Enabled options in the [9.2.7.3 Filter Options](#) of the Configuration Menu.

When sending external magnetometers the external heading flag will become active.

External Magnetometers Packet				
Packet ID		75		
Length		17		
Read / Write		Read / Write		
Field #	Bytes Offset	Data Type	Size	Description
1	0	fp32	4	Delay (s)
2	4	fp32	4	Magnetometer X (milligauss)
3	8	fp32	4	Magnetometer Y (milligauss)
4	12	fp32	4	Magnetometer Z (milligauss)
6	16	u8	1	External Magnetometer Flags

Table 125: External Magnetometers Packet

11.4.46.1 External Magnetometers Flags

Bit	Description
0	Magnetometers failure
1	Magnetometers over-range

Table 126: External magnetometers Flags

11.4.47 Basestation Packet

Basestation Packet				
Packet ID		80		
Length		45		
Read / Write		Read		
Field #	Bytes Offset	Data Type	Size	Description
1	0	u32	4	11.4.1.4 Unix Time Seconds
2	4	u32	4	11.4.1.5 Microseconds
3	8	fp64	8	Basestation position, latitude (rad)
4	16	fp64	8	Basestation position, longitude (rad)
5	24	fp64	8	Basestation position, altitude (rad)
6	32	fp32	4	Basestation relative position, north (m)
7	36	fp32	4	Basestation relative position, east (m)
8	40	fp32	4	Basestation relative position, down (m)
9	44	u8	1	11.4.47.1 GNSS Fix Status

Table 127: Basestation packet

11.4.47.1 GNSS Fix Status

Value	Description
0	No GNSS fix
1	2D GNSS fix
2	3D GNSS fix
3	SBAS GNSS fix
4	Differential GNSS fix
5	Omnistar/Starfire GNSS fix
6	RTK Float GNSS fix
7	RTK Fixed GNSS fix

Table 128: GNSS Fix Status

11.4.48 Zero Angular Velocity Packet

Zero Angular Velocity Packet				
Packet ID		83		
Length		8		
Read / Write		Write		
Field #	Bytes Offset	Data Type	Size	Description
1	0	fp32	4	Duration. See 11.4.48.1 Zero Angular Velocity Duration
2	4		4	Reserved (set to zero)

Table 129: Zero Angular Velocity Packet

11.4.48.1 Zero Angular Velocity Duration

Duration is the duration that the unit has been stationary for about the heading axis. The minimum value is 0.1 seconds and the maximum value is 2 seconds.

11.4.49 Extended Satellites Packet

Extended Satellites Packet				
Packet ID		84		
Length		2 + 9 x number of satellites		
Read / Write		Read		
Field #	Bytes Offset	Data Type	Size	Description
1	0	u8	1	Total number of extended satellites packets
2	1	u8	1	Packet number (range 1 to Total)
3	2	u8	1	Satellite System
4	3	u8	1	Satellite number (PRN)

Extended Satellites Packet				
5	4	s8	1	11.4.49.2 Satellite Frequencies
6	5	u8	1	Elevation (deg)
7	6	u16	2	Azimuth (deg)
8	8	u8	1	SNR receiver 1
9	9	u8	1	SNR receiver 2
10	10	u8	1	Flags. See Extended Satellites Flags
+				Fields 3-10 repeat for additional satellites

Table 130: Extended Satellites Packet

The maximum number of satellites per packet is 28. If there are more than 28 satellites to report, multiple packets will be sent per epoch. In this case the total number of packets in field #1 will be greater than 1, and the Packet Index in field #2 will increment accordingly.

11.4.49.1 Satellite Systems

Value	System
0	Unknown
1	GPS
2	GLONASS
3	BeiDou
4	Galileo
5	SBAS
6	QZSS
7	Reserved
8	Reserved
9	Reserved

Table 131: Satellite Systems

11.4.49.2 Satellite Frequencies

Value	GPS	GLONASS	Galileo	BeiDou	SBAS	QZSS
0	Unknown	Unknown	Unknown	Unknown	Unknown	Unknown
1	L1 C/A	G1 C/A	E1 OS	B1	L1 C/A	L1 C/A
2	L1 C		E1 PRS			L1 C
3	L1 P	G1 P				L1 SAIF
4	L1 M					
5	L2 C	G2 C/A	E6 CS	B2		L2 C
6	L2 P	G2 P	E6 PRS			LEX
7	L2 M					

Value	GPS	GLONASS	Galileo	BeiDou	SBAS	QZSS
8	L5	G3	E5 a	B3	L5	L5
9			E5 b			
10			E5 a+b			

Table 132: Satellite Frequencies

11.4.49.3 Extended Satellites Flags

Bit	Description
0	Visible by receiver 1
1	Visible by receiver 2
2	Used in primary position solution
3	Used in moving baseline solution
4-7	Reserved (set to zero)

Table 133: Extended Satellites Flags

11.4.50 Sensor Temperature Packet

Sensor Temperatures Packet				
Packet ID		85		
Length		32		
Read / Write		Read		
Field #	Bytes Offset	Data Type	Size	Description
1	0	fp32[3]	12	Accelerometer temperature
2	12	fp32[3]	12	Gyroscope temperature
3	24	fp32	4	Magnetometer temperature
4	28	fp32	4	Pressure sensor temperature

Table 134: Sensor temperature packet

11.5 Configuration Packets

Configuration packets can be both read from and written to the Certus. On many of the configuration packets the first byte is a permanent flag. A zero in this field indicates that the settings will be lost on reset, a one indicates that they will be permanent (i.e. stored in flash).

This section covers the following topics:

Packet ID	Name	Length	R/W
Configuration Packets			
180	11.5.1 Packet Timer Period Packet	4	R/W
181	11.5.2 Packets Period Packet	Varies	R/W
182	11.5.3 Baud Rates Packet	17	R/W
184	11.5.4 Sensor Ranges Packet	4	R/W
185	11.5.5 Installation Alignment Packet	73	R/W
186	11.5.6 Filter Options Packet	17	R/W
188	11.5.7 GPIO Configuration Packet	13	R/W
189	11.5.8 Magnetic Calibration Values Packet	49	R/W
190	11.5.9 Magnetic Calibration Configuration Packet	1	W
191	11.5.10 Magnetic Calibration Status Packet	3	R
192	11.5.11 Odometer Configuration Packet	8	R/W
193	11.5.12 Set Zero Orientation Alignment Packet	5	W
194	11.5.13 Reference Point Offsets Packet	49	R/W
195	11.5.14 GPIO Output Configuration Packet	183	R/W
196	11.5.15 Dual Antenna Configuration Packet	17	R/W
197	11.5.16 GNSS Configuration Packet	85	R/W
198	11.5.17 User Data Packet	64	R/W
199	11.5.18 GPIO Input Configuration Packet	65	R/W
202	11.5.19 IP Dataports Configuration Packet	30	R/W
203	11.5.20 CAN Configuration Packet	30	R/W

11.5.1 Packet Timer Period Packet

Packet Timer Period Packet				
Packet ID		180		
Length		4		
Read / Write		Read / Write		
Field #	Bytes Offset	Data Type	Size	Description
1	0	u8	1	Permanent
2	1	u8	1	11.5.1.1 UTC Synchronisation
3	2	u16	2	11.5.1.2 Packet Timer Period

Table 135: Packet Timer Period Packet

11.5.1.1 UTC Synchronisation

This is a boolean value that determines whether or not the packet timer is synchronised with UTC time, with zero for disabled and one for enabled. For UTC Synchronisation to be enabled the packet timer period must multiply into 1000000 evenly. For example if the packet timer period is 10000 (10 ms), $1000000/10000 = 100$ which is valid for UTC synchronisation. If the packet timer period is 15000 (15 ms), $1000000/15000 = 66.6666$ which is not valid for UTC synchronisation. To get the rate, use the following formula:

$$\text{Packet Timer Rate} = 1000000 / (\text{Packet Timer Period}) \text{ Hz}$$

11.5.1.2 Packet Timer Period

This is a value in microseconds that sets the master packet timer period. The minimum value is 1000 (1 ms) or 1000 Hz and the maximum value is 65000 (65 ms) or 15.38 Hz. The packet timer period must be in increments of 1000.

11.5.2 Packets Period Packet

This packet allows the user to configure, add, remove, modify and clear state packets (packets 20 through 180).

Note: This packet will only affect the port from which the packet is sent, leaving the other ports unaffected. e.g. If you are connected to the Primary serial port, sending this packet will only change the ANPP output for the Primary serial port.

Packets Period Packet				
Packet ID		181		
Length		2 + (5 x number of packet periods)		
Read / Write		Read / Write		
Field #	Bytes Offset	Data Type	Size	Description
1	0	u8	1	Permanent
2	1	u8	1	Clear Existing Packet Periods
3	2	u8	1	Packet ID

Packets Period Packet				
4	3	u32	4	Packet Period
+				Fields 3-4 repeat for additional packet periods

Table 136: Packets Period Packet

11.5.2.1 Clear Existing Packets

This is a boolean field, when set to one it deletes any existing packet rates. When set to zero existing packet rates remain. Only one packet rate can exist per packet ID, so new packet rates will overwrite existing packet rates for the same packet ID.

11.5.2.2 Packet Period

This indicates the period in units of the packet timer period. The packet rate can be calculated as follows.

$$\text{Packet Rate} = 1000000 / (\text{Packet Period} \times \text{Packet Timer Period}) \text{ Hz}$$

For example if the packet timer period is set to 1000 (1 ms). Setting packet ID 20 with a packet period of 50 will give the following.

$$\text{Packet 20 Rate} = 1000000 / (50 \times 1000)$$

$$\text{Packet 20 Rate} = 20 \text{ Hz}$$

11.5.3 Baud Rates Packet

Baud Rates Packet				
Packet ID		182		
Length		17		
Read / Write		Read / Write		
Field #	Bytes Offset	Data Type	Size	Description
1	0	u8	1	Permanent
2	1	u32	4	Primary RS232 and RS422 see 11.5.3.1 Supported Baud Rate bit #31: 0 = RS232, 1 = RS422
3	5	u32	4	GPIO 1 & 2 Maximum Baud Rate 250000 see 11.5.3.1 Supported Baud Rate
4	9	u32	4	Auxiliary RS232 see 11.5.3.1 Supported Baud Rate bit #31: 0 = RS232, 1 = RS422
5	13		4	Reserved (set to zero)

Table 137: Baud Rates Packet

11.5.3.1 Supported Baud Rate

Note: Not all Advanced Navigation products support minimum and maximum baud rates.

Supported Baud Rates - Bits 0-30
2400
4800
9600
19200
38400
57600
115200
230400
250000
460800
500000
800000
921600
1000000
1250000

Supported Baud Rates - Bits 0-30
2000000
4000000

Table 138: Supported Baud Rates

11.5.4 Sensor Ranges Packet

Note: The Sensor Ranges Packet is only valid for Certus units. This packet is not applicable for Certus Evo units.

Sensor Ranges Packet				
Packet ID		184		
Length		4		
Read / Write		Read / Write		
Field #	Bytes Offset	Data Type	Size	Description
1	0	u8	1	Permanent
2	1	u8	1	11.5.4.1 Accelerometers Range
3	2	u8	1	11.5.4.2 Gyroscopes Range
4	3		1	Reserved (set to 0)

Table 139: Sensor Ranges Packet

11.5.4.1 Accelerometers Range

Value	Description
0	2 g (19.62 m/s/s)
1	4 g (39.24 m/s/s)
2	16 g (156.96 m/s/s)

Table 140: Accelerometers Range

11.5.4.2 Gyroscopes Range

Value	Description
0	250 degrees/second
1	500 degrees/second
2	2000 degrees/second

Table 141: Gyroscopes Range

11.5.5 Installation Alignment Packet

Installation Alignment Packet				
Packet ID		185		
Length		73		
Read / Write		Read / Write		
Field #	Bytes Offset	Data Type	Size	Description
1	0	u8	1	Permanent

Installation Alignment Packet				
2	1	fp32	4	Alignment DCM[0][0]
3	5	fp32	4	Alignment DCM[0][1]
4	9	fp32	4	Alignment DCM[0][2]
5	13	fp32	4	Alignment DCM[1][0]
6	17	fp32	4	Alignment DCM[1][1]
7	21	fp32	4	Alignment DCM[1][2]
8	25	fp32	4	Alignment DCM[2][0]
9	29	fp32	4	Alignment DCM[2][1]
10	33	fp32	4	Alignment DCM[2][2]
11	37	fp32	4	GNSS antenna offset X (m)
12	41	fp32	4	GNSS antenna offset Y (m)
13	45	fp32	4	GNSS antenna offset Z (m)
14	49	fp32	4	Odometer offset X (m) ¹
15	53	fp32	4	Odometer offset Y (m) ¹
16	57	fp32	4	Odometer offset Z (m) ¹
17	61	fp32	4	External data offset X (m) ²
18	65	fp32	4	External data offset Y (m) ²
19	69	fp32	4	External data offset Z (m) ²
¹ Odometer offset is used for Odometer and DVL input				
² External data offset is used for NMEA input, External GNSS and Air Data Unit				

Table 142: Installation Alignment Packet

11.5.5.1 Alignment DCM

The alignment DCM (Direction Cosine Matrix) is used to represent an alignment offset of Certus from its standard alignment. A DCM is used rather than Euler angles for accuracy reasons. To convert Euler angles to DCM, use the formula below with angles in radians.

$$DCM[0][0] = \cos(\text{heading}) * \cos(\text{pitch})$$

$$DCM[0][1] = \sin(\text{heading}) * \cos(\text{pitch})$$

$$DCM[0][2] = -\sin(\text{pitch})$$

$$DCM[1][0] = -\sin(\text{heading}) * \cos(\text{roll}) + \cos(\text{heading}) * \sin(\text{pitch}) * \sin(\text{roll})$$

$$DCM[1][1] = \cos(\text{heading}) * \cos(\text{roll}) + \sin(\text{heading}) * \sin(\text{pitch}) * \sin(\text{roll})$$

$$DCM[1][2] = \cos(\text{pitch}) * \sin(\text{roll})$$

$$DCM[2][0] = \sin(\text{heading}) * \sin(\text{roll}) + \cos(\text{heading}) * \sin(\text{pitch}) * \cos(\text{roll})$$

$$DCM[2][1] = -\cos(\text{heading}) * \sin(\text{roll}) + \sin(\text{heading}) * \sin(\text{pitch}) * \cos(\text{roll})$$

$$DCM[2][2] = \cos(\text{pitch}) * \cos(\text{roll})$$

11.5.6 Filter Options Packet

Filter Options Packet				
Packet ID		186		
Length		17		
Read / Write		Read / Write		
Field #	Bytes Offset	Data Type	Size	Description
1	0	u8	1	Permanent
2	1	u8	1	11.5.6.1 Vehicle Types
3	2	u8	1	Internal GNSS enabled (boolean)
4	3	u8	1	Magnetic Heading enabled (boolean)
5	4	u8	1	Atmospheric altitude enabled (boolean)
6	5	u8	1	Velocity heading enabled (boolean)
7	6	u8	1	Reversing detection enabled (boolean)
8	7	u8	1	Motion analysis enabled (boolean)
9	8	u8	1	Automatic magnetic calibration enabled (boolean)
10	9	u8	1	Dual antenna disabled
11	10		7	Reserved (set to zero)

Table 143: Filter Options Packet

11.5.6.1 Vehicle Types

Value	Description
0	Unlimited
1	Bicycle or Motorcycle
2	Car

Value	Description
3	Hovercraft
4	Submarine
5	3D Underwater Vehicle
6	Fixed Wing Plane
7	3D Aircraft
8	Human
9	Boat
10	Large Ship
11	Stationary
12	Stunt Plane
13	Race Car

Table 144: Vehicle Types

11.5.7 GPIO Configuration Packet

GPIO Configuration Packet				
Packet ID		188		
Length		13		
Read / Write		Read / Write		
Field #	Bytes Offset	Data Type	Size	Description
1	0	u8	1	Permanent
2	1	u8	1	GPIO1 function. See 11.5.7.1 GPIO Functions
3	2	u8	1	GPIO2 function. See 11.5.7.1 GPIO Functions
4	3	u8	1	Auxiliary RS232 transmit function. See 11.5.7.2 Auxiliary Functions
5	4	u8	1	Auxiliary RS232 receive function. See 11.5.7.2 Auxiliary Functions
6	5	u8	1	11.5.7.3 GPIO Voltage Selection
7	6		7	Reserved (set to zero)

Table 145: GPIO Configuration Packet

11.5.7.1 GPIO Functions

Value	Description	GPIO Function Type
0	Inactive	GPIO1, GPIO2
1	1PPS Output	
2	GNSS Fix Output	
3	Odometer Input	
4	Zero Velocity Input	
5	Pitot Tube Input	
6	NMEA Input	GPIO2
7	NMEA Output	GPIO1
8	Novatel GNSS Input	GPIO2
9	Topcon GNSS Input	
11	ANPP Input	
12	ANPP Output	GPIO1
13	Disable Magnetometers	GPIO1, GPIO2
14	Disable GNSS	GPIO1, GPIO2
15	Disable Pressure	
16	Set Zero Orientation Alignment	
17	System State Packet Trigger	
18	Raw Sensors Packet Trigger	
19	RTCM Differential GNSS Corrections Input	GPIO2
20	Trimble GNSS Input	
21	u-blox GNSS Input	
22	Hemisphere GNSS Input	
23	Teledyne DVL Input	
24	Tritech USBL Input	
25	Linkquest DVL Input	

Value	Description	GPIO Function Type
26	Pressure Depth Transducer	GPIO1, GPIO2
27	Left Wheel Speed Sensor	
28	Right Wheel Speed Sensor	
29	1PPS Input	
30	Wheel Speed Sensor	
31	Wheel Encoder Phase A	
32	Wheel Encoder Phase B	
33	Event 1 Input	
34	Event 2 Input	
35	Linkquest USBL Input	
38	GNSS Receiver Passthrough	GPIO1, GPIO2
39	TSS1 Output	GPIO1
40	Simrad 1000 Output	
41	Simrad 3000 Output	
42	Serial Port Passthrough	GPIO1, GPIO2
43	Gimbal Encoder Phase A	
44	Gimbal Encoder Phase B	
45	Odometer Direction, Forward Low	
46	Odometer Direction, Forward High	
51	Nortek DVL Input	GPIO2
53	Reverse Alignment, Forward Low	GPIO1, GPIO2
54	Reverse Alignment, Forward High	
55	Zero Angular Velocity Input	

Table 146: GPIO functions

11.5.7.2 Auxiliary Functions

Value	Description	Auxiliary Function Type
0	Inactive	Transmit, Receive
1	1PPS Output	Transmit
2	GNSS Fix Output	
3	Odometer Input	Receive
4	Zero Velocity Input	
5	Pitot Tube Input	
6	NMEA Input	
7	NMEA Output	Transmit

Value	Description	Auxiliary Function Type
8	Novatel GNSS Input	Receive
9	Topcon GNSS Input	
11	ANPP Input	
12	ANPP Output	Transmit
13	Disable magnetometers	Receive
14	Disable GNSS	Receive
15	Disable Pressure	
16	Set Zero Orientation Alignment	
17	System State Packet Trigger	
18	Raw Sensors Packet Trigger	
19	RTCM Differential GNSS Corrections Input	
20	Trimble GNSS Input	
21	u-blox GNSS Input	
22	Hemisphere GNSS Input	
23	Teledyne DVL Input	
24	Tritech USBL Input	
25	Linkquest DVL Input	
26	Pressure Depth Transducer	
27	Left Wheel Speed Sensor	
28	Right Wheel Speed Sensor	
29	1PPS Input	
30	Wheel Speed Sensor	
33	Event 1 Input	
34	Event 2 Input	
35	Linkquest USBL Input	
38	GNSS Receiver Passthrough	Transmit, Receive
39	TSS1 Output	Transmit
40	Simrad 1000 Output	
41	Simrad 3000 Output	
42	Serial Port Passthrough	Transmit, receive

Value	Description	Auxiliary Function Type
45	Odometer Direction, Forward Low	Receive
46	Odometer Direction, Forward High	
51	Nortek DVL Input	
53	Reverse Alignment, Forward Low	
54	Reverse Alignment, Forward High	
55	Zero Angular Velocity Input	

Table 147: Auxiliary Functions

11.5.7.3 GPIO Voltage Selection

Value	Description
0	5V
1	3.3V
2	Power Disabled

Table 148: GPIO Voltage Selection

11.5.8 Magnetic Calibration Values Packet

This packet can be used to inspect the magnetic calibration values or write custom magnetic calibration values to the system. Under normal operation with automatic magnetic calibration the user should not need to use this packet.

Magnetic Calibration Values Packet				
Packet ID		189		
Length		49		
Read / Write		Read / Write		
Field #	Bytes Offset	Data Type	Size	Description
1	0	u8	1	Permanent
2	1	fp32	4	Hard iron bias X
3	5	fp32	4	Hard iron bias Y
4	9	fp32	4	Hard iron bias Z
5	13	fp32	4	Soft iron transformation XX
6	17	fp32	4	Soft iron transformation XY
7	21	fp32	4	Soft iron transformation XZ
8	25	fp32	4	Soft iron transformation YX
9	29	fp32	4	Soft iron transformation YY
10	33	fp32	4	Soft iron transformation YZ
11	37	fp32	4	Soft iron transformation ZX

Magnetic Calibration Values Packet				
12	41	fp32	4	Soft iron transformation ZY
13	45	fp32	4	Soft iron transformation ZZ

Table 149: Magnetic Calibration Values Packet

11.5.9 Magnetic Calibration Configuration Packet

Magnetic Calibration Configuration Packet				
Packet ID		190		
Length		1		
Read / Write		Write		
Field #	Bytes Offset	Data Type	Size	Description
1	0	u8	1	11.5.9.1 Magnetic Calibration Actions

Table 150: Magnetic Calibration Configuration Packet

11.5.9.1 Magnetic Calibration Actions

Value	Description
0	Cancel magnetic calibration
2	Start 2D magnetic calibration
3	Start 3D magnetic calibration
4	Reset calibration to defaults

Table 151: Magnetic Calibration Actions

11.5.10 Magnetic Calibration Status Packet

Magnetic Calibration Status Packet				
Packet ID		191		
Length		3		
Read / Write		Read		
Field #	Bytes Offset	Data Type	Size	Description
1	0	u8	1	11.5.10.1 Magnetic Calibration Status
2	1	u8	1	Magnetic calibration progress (%)
3	2	u8	1	Local magnetic error (%)

Table 152: Magnetic Calibration Status Packet

11.5.10.1 Magnetic Calibration Status

Value	Description
0	Magnetic calibration not completed
1	2D magnetic calibration completed

Value	Description
2	3D magnetic calibration completed
3	Custom values magnetic calibration completed
5	2D calibration in progress
6	3D calibration in progress
7	2D calibration error: excessive roll
8	2D calibration error: excessive pitch
9	Calibration error: sensor over range event
10	Calibration error: time-out
11	Calibration error: system error
12	Calibration error: interference error

Table 153: Magnetic Calibration Status

11.5.11 Odometer Configuration Packet

Odometer Configuration Packet				
Packet ID		192		
Length		8		
Read / Write		Read / Write		
Field #	Bytes Offset	Data Type	Size	Description
1	0	u8	1	Permanent
2	1	u8	1	Automatic pulse measurement active
3	2		2	Reserved (set to zero)
4	4	fp32	4	Pulse length (m)

Table 154: Odometer Configuration Packet

11.5.12 Set Zero Orientation Alignment Packet

Set Zero Orientation Alignment Packet				
Packet ID		193		
Length		5		
Read / Write		Write		
Field #	Bytes Offset	Data Type	Size	Description
1	0	u8	1	Permanent
2	1	u32	4	Verification sequence (set to 0x9A4E8055)

Table 155: Set Zero Orientation Alignment Packet

11.5.13 Reference Point Offsets Packet

The reference point offsets packet can be used to adjust the measurement point that all data is referenced to. By default all the values of this packet are zero and the measurement point that all data is referenced to is the centre of the Certus unit. The primary reference point offset can be used to adjust the measurement point to a different location on the vehicle, in the body co-ordinate frame. The primary reference point offset applies to all data output including NMEA etc as well as heave point 1.

The other heave point offsets do not apply to heave point 1 in the [11.4.37 Heave Packet](#).

Reference Point Offsets Packet				
Packet ID		194		
Length		49		
Read / Write		Read / Write		
Field #	Bytes Offset	Data Type	Size	Description
1	0	u8	1	Permanent
2	1	fp32	4	Heave point 1 offset X (m) / Primary reference point offset X (m)
3	5	fp32	4	Heave point 1 offset Y (m) / Primary reference point offset Y (m)
4	9	fp32	4	Heave point 1 offset Z (m) / Primary reference point offset Z (m)
5	13	fp32	4	Heave point 2 offset X (m)
6	17	fp32	4	Heave point 2 offset Y (m)
7	21	fp32	4	Heave point 2 offset Z (m)
8	25	fp32	4	Heave point 3 offset X (m)
9	29	fp32	4	Heave point 3 offset Y (m)
10	33	fp32	4	Heave point 3 offset Z (m)
11	37	fp32	4	Heave point 4 offset X (m)
12	41	fp32	4	Heave point 4 offset Y (m)
13	45	fp32	4	Heave point 4 offset Z (m)

Table 156: Reference Point Offsets Packet

11.5.14 GPIO Output Configuration Packet

GPIO Output Configuration Packet				
Packet ID				195
Length				183
Read / Write				Read / Write
Field #	Bytes Offset	Data Type	Size	Description
1	0	u8	1	Permanent
2	1	u8	1	Auxiliary port Input Mode. See 11.5.14.1 Port Input Modes
3	2	u8	1	Auxiliary port Output Mode. See 11.5.14.2 Port Output Modes
4	3	u8	1	Auxiliary port NMEA fix behaviour. See 11.5.14.3 NMEA Fix Behaviour
5	4	u8	1	Auxiliary port GPZDA Rates. See 11.5.14.4 Port Output Rates
6	5	u8	1	Auxiliary port GPGGA Rates. See 11.5.14.4 Port Output Rates
7	6	u8	1	Auxiliary port GPVTG Rates. See 11.5.14.4 Port Output Rates
8	7	u8	1	Auxiliary port GPRMC Rates. See 11.5.14.4 Port Output Rates
9	8	u8	1	Auxiliary port GPHDT Rates. See 11.5.14.4 Port Output Rates
10	9	u8	1	Auxiliary port GPGLL Rates. See 11.5.14.4 Port Output Rates
11	10	u8	1	Auxiliary port PASHR Rates. See 11.5.14.4 Port Output Rates
12	11	u8	1	Auxiliary port TSS1 Rates. See 11.5.14.4 Port Output Rates
13	12	u8	1	Auxiliary port Simrad Rates. See 11.5.14.4 Port Output Rates
14	13	u8	1	Auxiliary port GPROT Rates. See 11.5.14.4 Port Output Rates
15	14	u8	1	Auxiliary port GPHEV Rates. See 11.5.14.4 Port Output Rates
16	15	u8	1	Auxiliary port GPGSV Rates. See 11.5.14.4 Port Output Rates
17	16	u8	1	Auxiliary port PFECAtt Rates. See 11.5.14.4 Port Output Rates

GPIO Output Configuration Packet				
18	17	u8	1	Auxiliary port PFECHe Rates. See 11.5.14.4 Port Output Rates
19	18	u8	1	Auxiliary port GPGST Rates. See 11.5.14.4 Port Output Rates
20	19	u8[8]	8	Reserved (set to zero)
+				Fields 2-20 Repeat 6 more times (a total of 7 copies) for: GPIO port Logging port Data Port #1 Data Port #2 Data Port #3 Data Port #4

Table 157: GPIO Output Configuration Packet

11.5.14.1 Port Input Modes

Value	Description
0	Inactive
6	NMEA0183
11	ANPP
38	GNSS Receiver Passthrough

Table 158: Port Input Modes

11.5.14.2 Port Output Modes

Value	Description
0	Inactive
7	NMEA0183
12	ANPP
38	GNSS Receiver Passthrough
39	TSS1
40	Simrad 1000
41	Simrad 3000

Table 159: Port Output Modes

Note: The Port Input and Output Modes are read only for the auxiliary and GPIO ports. For compatibility with legacy devices, the modes for these two ports are set using the GPIO Configuration Packet.

11.5.14.3 NMEA Fix Behaviour

Value	Description
0	Normal

Value	Description
1	Always indicate 3D fix when the navigation filter is initialised

Table 160: NMEA Fix Behaviour

11.5.14.4 Port Output Rates

Value	Bit 3	Bit 2	Bit 1	Bit 0	Description
0	0	0	0	0	Disabled
1	0	0	0	1	0.1 Hz
2	0	0	1	0	0.2 Hz
3	0	0	1	1	0.5 Hz
4	0	1	0	0	1 Hz
5	0	1	0	1	2 Hz
6	0	1	1	0	5 Hz
7	0	1	1	1	10 Hz
8	1	0	0	0	25 Hz
9	1	0	0	1	50 Hz
10	1	0	1	0	8 Hz

Table 161: Port Output Rates

11.5.15 Dual Antenna Configuration Packet

By default the system uses automatic offset with primary front and secondary rear.

When using an automatic offset:

- There are four available configurations, listed in the Automatic Offset Orientations table below.
- Manual offset values will be ignored and should be set to zero.
- The manual offset values will be populated with the automatically calculated offset values.

If your antenna configuration does not match one of the four available automatic offset configurations you must use a manual offset. These values are measured from the secondary antenna to the primary antenna in the body co-ordinate frame.

Dual Antenna Configuration Packet				
Packet ID		196		
Length		17		
Read / Write		Read / Write		
Field #	Bytes Offset	Data Type	Size	Description
1	0	u8	1	Permanent
2	1	u16	2	Offset type
3	3	u8	1	Automatic offset orientation

Dual Antenna Configuration Packet				
4	4	u8	1	Reserved (set to zero)
5	5	fp32	4	Manual offset X (m)
6	9	fp32	4	Manual offset Y (m)
7	13	fp32	4	Manual offset Z (m)

Table 162: Dual Antenna Configuration Packet

11.5.15.1 Offset Types

Value	Description
0	Manual offset
1	Automatic offset

Table 163: Offset Types

11.5.15.2 Automatic Offset Orientations

Value	Description
0	Primary front and secondary rear
1	Primary rear and secondary front
2	Primary right and secondary left
3	Primary left and secondary right

Table 164: Automatic Offset Orientations

11.5.16 GNSS Configuration Packet

11.5.16.1 Aries GNSS Receiver

Aries GNSS Receiver Configuration Packet				
Packet ID		197		
Length		85		
Read / Write		Read / Write		
Field #	Bytes Offset	Data Type	Size	Description
1	0	u8	1	Permanent
2	1	u64	8	GNSS frequencies. This is a bitfield where each bit describes whether a particular frequency is enabled. For a list of the fields that are currently available, see 11.5.16.3 GNSS Frequency Bitfields .
3	9		76	Reserved (set to 0)

Table 165: Aries GNSS Receiver Configuration Packet

11.5.16.2 Trimble BD992 GNSS Receiver

Trimble BD992 GNSS Receiver Configuration Packet				
Packet ID		197		
Length		85		
Read / Write		Read / Write		
Field #	Bytes Offset	Data Type	Size	Description
1	0	u8	1	Permanent
2	1	u64	8	GNSS frequencies. This is a bitfield where each bit describes whether a particular frequency is enabled. For a list of the fields that are currently available, see 11.5.16.3 GNSS Frequency Bitfields .
3	9	fp32	4	PDOP threshold - the Position Dilution of Precision to achieve a fix
4	13	fp32	4	TDOP threshold - The Time dilution of Precision to achieve a fix
5	17	u8	1	Elevation mask (degrees) - Minimum elevation of the satellite that will be used when calculating fix
6	18	u8	1	SNR Mask (dB) - Signal-to-noise (SNR) ratio of a satellite signal to allow it to be used when calculating a fix
7	19	u8	1	SBAS corrections enabled
8	20	u8	1	11.5.16.4 L Band Modes
9	21	u32	4	L band frequency (Hz)
10	25	u32	4	L band baud rate
11	29	u32	4	Primary antenna type
12	33	u32	4	Secondary antenna type
13	37	u8	1	11.5.16.5 L Band Satellite IDs - this refers to the satellite name
14	38		47	Reserved

Table 166: Trimble BD992 GNSS Receiver Configuration Packet

11.5.16.3 GNSS Frequency Bitfields

Each GNSS frequency is a field that contains 8 bits that indicate whether a particular frequency is enabled for a constellation. These are boolean fields with a zero indicating false and a one indicating true. The table below provides a description of each bit, which is a combination of a constellation name and its frequency.

Bit	Description
0	GPS L1CA
1	GPS L1C
2	GPS L1P

Bit	Description
3	GPS L2C
4	GPS L2P
5	GPS L2M
6	GPS L5
7	GLONASS G1CA
8	GLONASS G1P
9	GLONASS L1OC
10	GLONASS L1SC
11	GLONASS G2CA
12	GLONASS G2P
13	GLONASS L2OC
14	GLONASS L2SC
15	GLONASS L3OC
16	GLONASS L3SC
17	BEIDOU B1
18	BEIDOU B2
19	BEIDOU B3
20	GALILEO E1
20	GALILEO E5A
22	GALILEO E5B
23	GALILEO E5AB
24	GALILEO E6
25	QZSS L1CA
25	QZSS L1SAIF
26	QZSS L1C
27	QZSS L2C
28	QZSS L5
29	QZSS LEX
30	SBAS L1CA

11.5.16.4 L Band Modes

L Band Mode	L Band Mode Name
0	Disabled
2	Omnistar Auto

L Band Mode	L Band Mode Name
3	Omnistar HP
4	Omnistar XP
5	Omnistar VBS
8	Omnistar G2
9	Omnistar HP+G2
10	Omnistar HP+XP
11	Trimble RTX
13	Omnistar L1 Only
14	Omnistar G4 Only
15	Omnistar G2+ Only
16	Omnistar G4+ Only

Table 167: L Band Modes

11.5.16.5 L Band Satellite IDs

L Band Satellite ID	Satellite Name
110	Auto
100	Custom
2	IOSAT
8	AORET
15	RTXMX
16	AMSAT
17	WASAT
18	OCSAT
19	RTXAL
20	RTXIO
22	CONNA
23	RTXNA
27	RTXPA
29	RTXEA
30	EMSAT

Table 168: L Band Satellite IDs

11.5.17 User Data Packet

This packet is for storage of users data. The data itself is not used by Certus.

User Data Packet				
Packet ID		198		
Length		64		
Read / Write		Read / Write		
Field #	Bytes Offset	Data Type	Size	Description
1	0		64	User Data

Table 169: User Data Packet

11.5.18 GPIO Input Configuration Packet

GPIO Input Configuration Packet				
Packet ID		199		
Length		65		
Read / Write		Read / Write		
Field #	Bytes Offset	Data Type	Size	Description
1	0	u8	1	Permanent
2	1	fp32	4	Gimbal radians per encoder tick
3	5		60	Reserved (set to zero)

Table 170: GPIO Input Configuration Packet

11.5.19 IP Dataports Configuration Packet

IP Dataports Configuration Packet				
Packet ID		202		
Length		30		
Read / Write		Read / Write		
Field #	Bytes Offset	Data Type	Size	Description
1	0	u16	2	Reserved
2	2	u32	4	TCP/UDP IP Address
3	6	u16	2	TCP/UDP Port
4	8	u8	1	11.5.19.1 IP Dataport Mode
+				Fields 2-4 Repeat 3 times (a total of 4 copies) for each of the 4 data ports

Table 171: IP Dataports Configuration Packet

11.5.19.1 IP Dataport Mode

Value	Description
0	MODE_NONE

Value	Description
1	Reserved
2	MODE_TCP_SERVER
3	MODE_TCP_CLIENT
4	MODE_UDP

Table 172: IP Dataport Mode

11.5.20 CAN Configuration Packet

CAN Configuration Packet				
Packet ID		203		
Length		11		
Read / Write		Read / Write		
Field #	Bytes Offset	Data Type	Size	Description
1	0	u8	1	Permanent
2	1	u8	1	Enabled
3	2	u32	4	Baud Rate
4	6	u8	1	CAN Protocol
5	7	u8	4	Reserved (set to zero)

Table 173: CAN Configuration Packet

11.5.20.1 CAN Protocol

Value	Description
0	CANopen

Table 174: CAN Protocol

12 Reference Information

This chapter is a learning reference that briefly covers knowledge essential to understanding Certus and INS generally. It explains the following concepts in simple terms so that people unfamiliar with the technology may understand it:

- [12.1 Technology Overview](#), including Global Navigation Satellite System (GNSS), Inertial Navigation System (INS) and Attitude and Heading Reference System (AHRS)
- [12.2 The Sensor Co-ordinate Frame](#)
- [12.3 The Body Co-ordinate Frame](#)
- [12.4 Roll, Pitch and Heading](#)
- [12.5 Geodetic Co-ordinate System](#)
- [12.6 NED Co-ordinate Frame](#)
- [12.7 ECEF Co-ordinate Frame](#)

12.1 Technology Overview

12.1.1 GNSS

GNSS stands for Global Navigation Satellite System. A GNSS consists of a set of satellites in medium Earth orbit that broadcast navigation signals with a common operator. These navigation signals can be picked up by a GNSS receiver on the earth to estimate that receiver's position and velocity. For a long time the only operational GNSS was the United States GPS. However, the Russian GLONASS, the Chinese BeiDou GNSS, and the European Union's Galileo GNSS are fully operational.

GNSS provides a fairly accurate absolute position (down to 1.2 metres without assistance and as low as 8 mm with) and velocity (as low as 0.007 metres/second). The main drawback of GNSS is that the receiver must have a clear signal from at least 4 satellites to function. GNSS signals are very weak and struggle to penetrate through buildings, trees and other objects obstructing an uninterrupted view of the sky. GNSS can also occasionally drop out due to disturbances in the upper atmosphere, or the presence of jammers.

12.1.2 AHRS

AHRS stands for Attitude and Heading Reference System. An AHRS uses accelerometers, magnetometer data and gyroscopes combined in a mathematical algorithm to provide orientation. Orientation consists of the three body angles roll, pitch and heading.

12.1.3 INS

INS stands for Inertial Navigation System. An inertial navigation system can provide position and velocity similar to GNSS but with some major differences. The principle of inertial navigation is the measurement of acceleration, which is then integrated into velocity. The velocity is then further integrated to estimate position. Due to noise in the measurement and the compounding of that noise through the integration steps, inertial navigation has an error that increases exponentially over time. Inertial navigation systems have a very low relative error over short time periods but over long time periods the error can increase enormously.

12.1.4 GNSS/INS

By combining GNSS and INS together in a mathematical algorithm, it is possible to take advantage of the benefits of the long-term precision of GNSS and the short-term accuracy of inertial sensors. This provides an

enhanced position and velocity solution that can withstand GNSS drop outs.

12.2 The Sensor Co-ordinate Frame

Inertial sensors have 3 different axes: X, Y and Z and these determine the references around which angles and accelerations are measured. It is very important to align these axes correctly in installation, otherwise the system won't work correctly.

These axes are marked on the top of the device as shown in [Figure 112: Certus Axes](#) below, with the X axis pointing in the direction of the connectors, the Z axis pointing down through the base of the unit and the Y axis pointing off to the right.

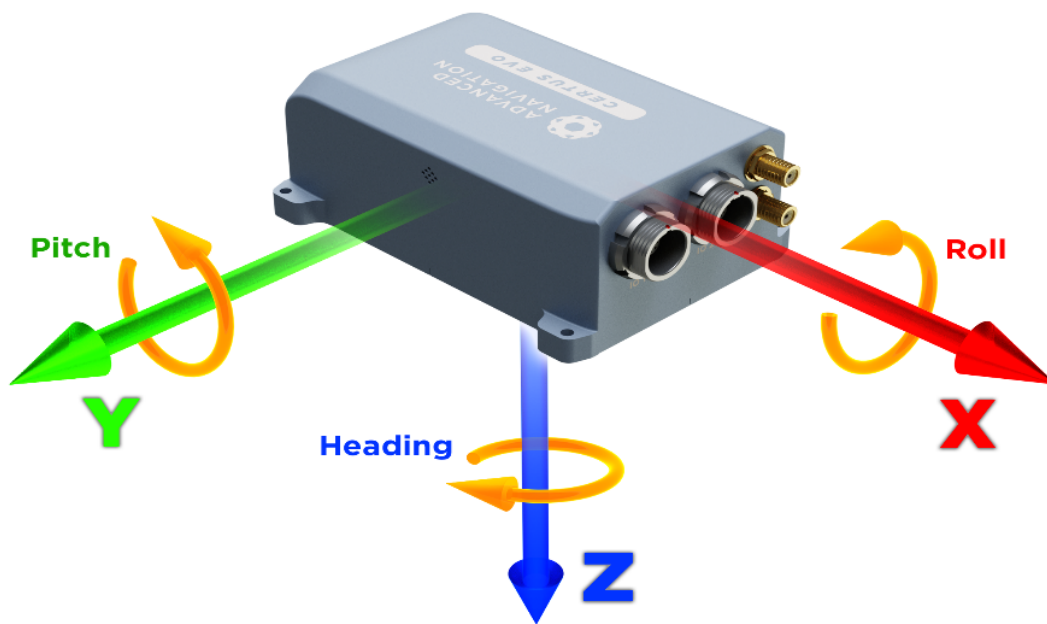

Figure 112: Certus Axes

12.2.1 Right Hand Rule

When installed in an application the X axis should be aligned such that it points forwards and the Z axis aligned so that it points down when the system is level. A good way to remember the sensor axes is the right hand rule, which is visualised in [Figure 113: First Right-hand Rule](#).

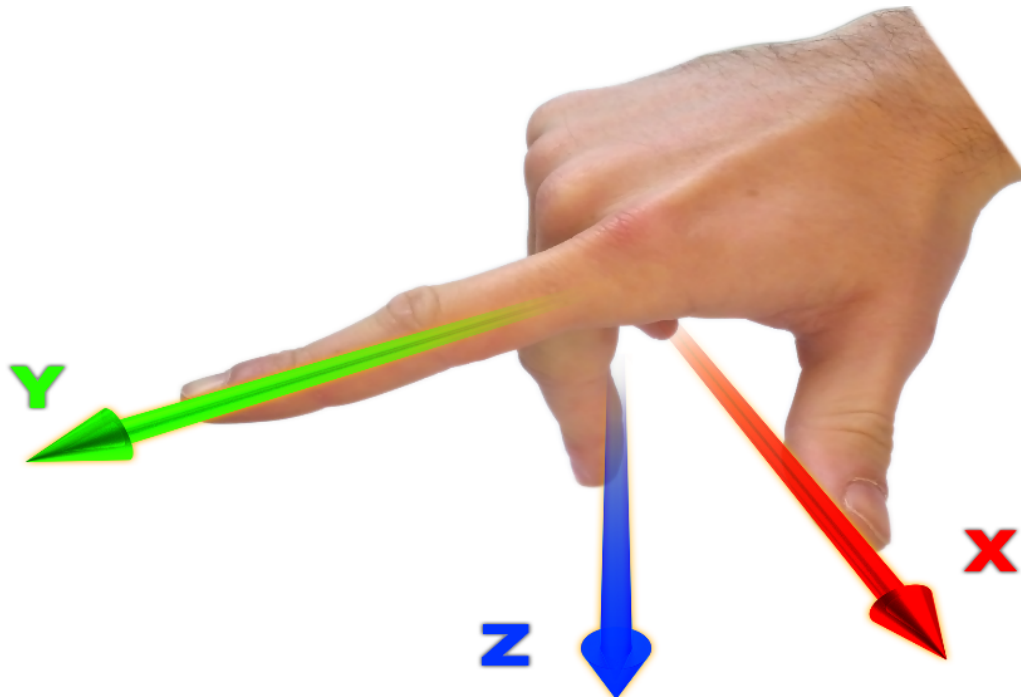

Figure 113: First Right-hand Rule

You take your right hand and extend your thumb, index and middle. Your thumb then denotes the positive X axis, your index denotes the positive Y axis and your middle denotes the positive Z axis.

12.3 The Body Co-ordinate Frame

Also known as the vehicle co-ordinate (reference) frame, this can be described most easily using a car (the body or vehicle) as an example. The forward direction of travel for a car is the positive X axis, out to the right of the car is the positive Y axis, and down is the positive Z axis. The distinction between the sensor co-ordinate frame and the body co-ordinate frame becomes important when the INS device is not mounted with its axes aligned to the vehicle axes, for example when the INS is mounted with a 90 degree heading rotation. Offset measurements, which are described later in this document, will always be in the body co-ordinate frame to remove any INS alignment variations. Generally any data output by the INS using the X, Y and Z axes will be using the body co-ordinate frame.

12.4 Roll, Pitch and Heading

Orientation can be described by the three angles roll, pitch and heading: these are known as the Euler angles. The rotation axes of roll, pitch and heading are shown visually in [Figure 112: Certus Axes](#). The arrow indicates the positive rotation direction.

Roll is the angle around the X axis and is zero when the unit is level. Pitch is the angle around the Y axis and is zero when the unit is level. Heading is the angle around the Z axis and is zero when the positive X axis is pointing to true north.

12.4.1 Second Right Hand Rule

The two right hand rules are often the best way to memorise the sensor axes and directions of positive rotation. The first right hand rule gives the positive axis directions and is described in [12.2 The Sensor Co-ordinate Frame](#). The second right hand rule shown in the figure below provides the direction of positive rotation. To use

it, point your thumb in the positive direction of that axis, then the direction that your fingers curl over shows the positive rotation on that axis.

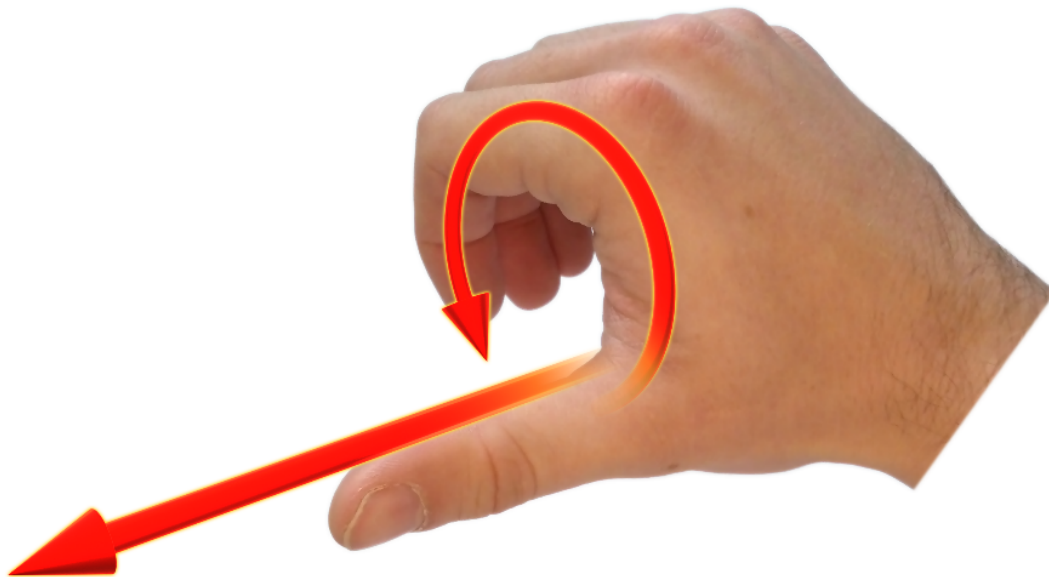

Figure 114: Second right Hand Rule

12.4.2 Rotation Order

When multiple axes are rotated, to imagine the final orientation the three rotations must be performed in the order heading first, then pitch and then roll. To deduce the final orientation the unit should first be considered level with the X axis pointing north and the Z axis pointing down. Heading is applied first, then pitch is applied and finally roll is applied to give the final orientation. This can be hard for some people to grasp at first and is often best learned experimentally by rotating Certus with your hand whilst watching the orientation plot in real time on the computer.

12.5 Geodetic Co-ordinate System

The geodetic co-ordinate system is the most popular way of describing an absolute position on the Earth. It is made up of two angles, latitude and longitude, combined with a height relative to an ellipsoid.

12.5.1 Latitude and Longitude

Latitude is the angle that specifies the north to south position of a point on the Earth's surface, reported as $\pm 90^\circ$. Longitude is the angle that specifies the east to west position of a point on the Earth's surface, reported as $\pm 180^\circ$. The line of zero latitude is the equator, and the line of zero longitude is the prime meridian. See [Figure 115: Latitude and longitude represented visually to describe a position on an ellipsoid](#).

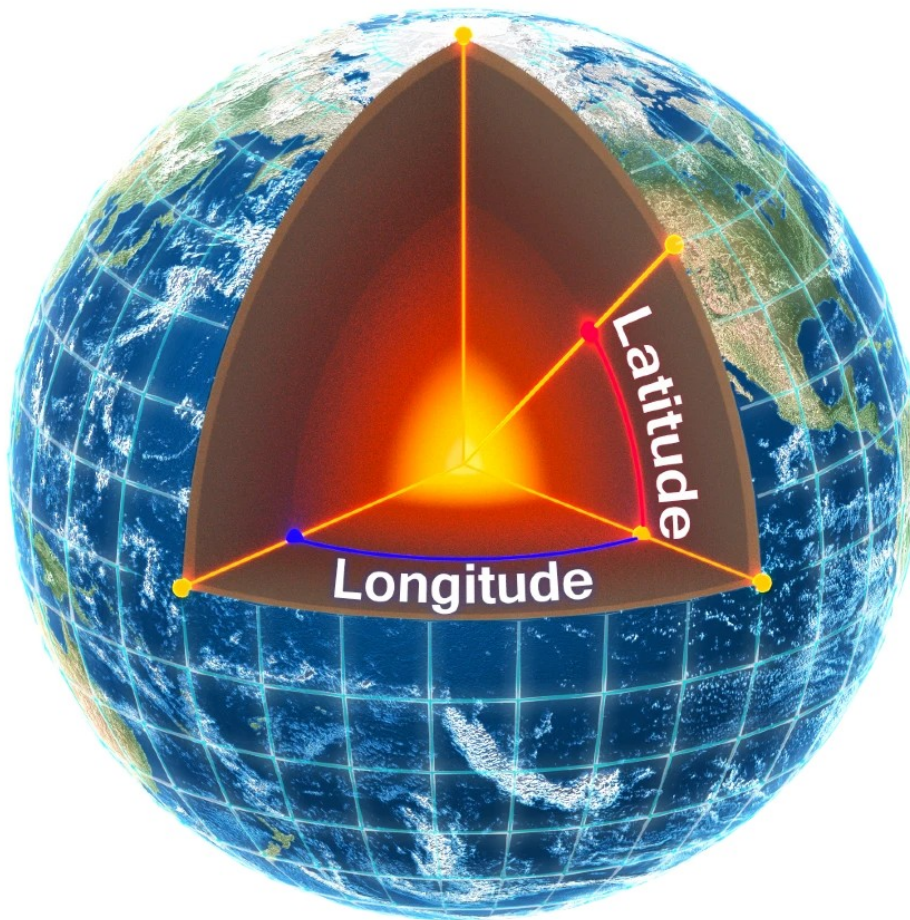

Figure 115: Latitude and longitude represented visually to describe a position on an ellipsoid

The figure below shows latitude and longitude on a map of the world, represented with a standard Mercator projection.

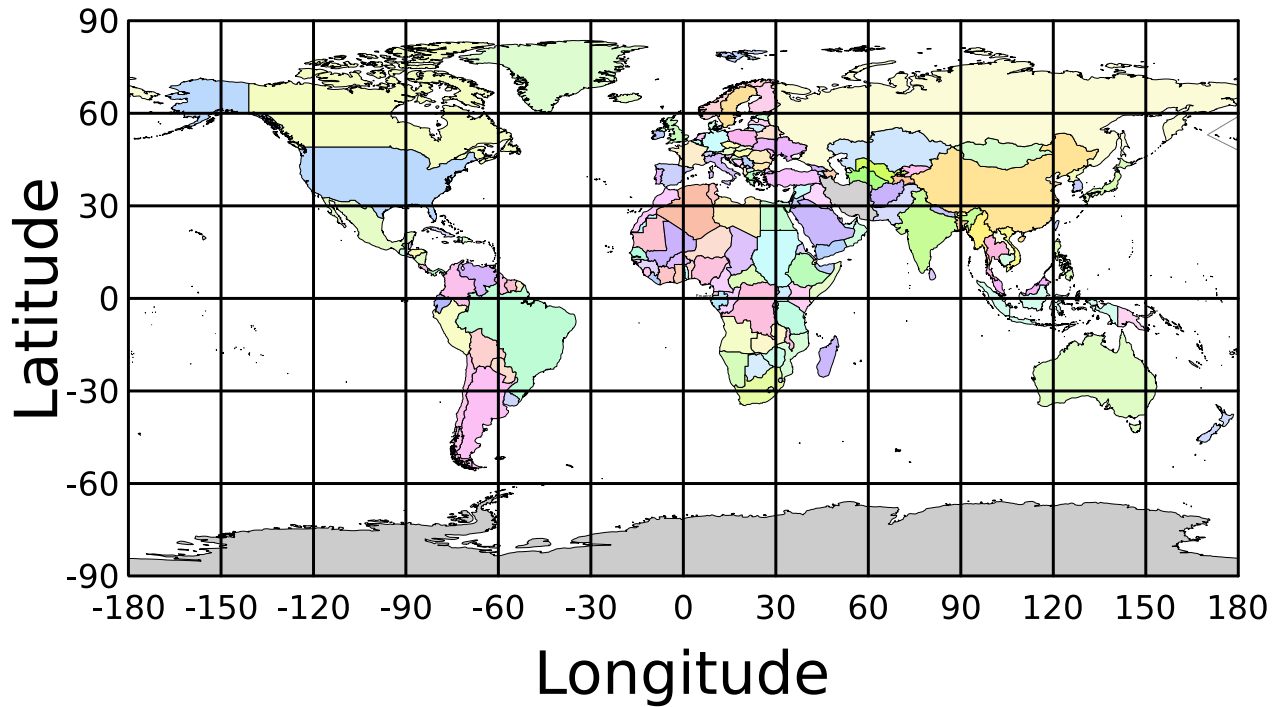

Figure 116: World map showing latitudes and longitudes

Latitude and longitude give the 2D point on the surface of the Earth. These are combined with height to give the 3D position on the Earth.

12.5.2 Height

Any height data output by Advanced Navigation devices is the height referenced the WGS84 reference ellipsoid. The WGS84 reference ellipsoid is a smooth mathematical model that approximates the form of the surface of the earth. The ellipsoid height (as used by GNSS) is not referenced to mean sea level; the height from the EGM96 geoid (orthometric height) approximates the height above mean sea level (MSL).

See [Figure 117: Orthometric, ellipsoid and geoid height diagram](#) below for a visual representation of geoid height, ellipsoid height and orthometric height (height above mean sea level).

Note:

Ellipsoid height refers to the height of a point of interest referenced to the WGS84 reference ellipsoid. Geoid height refers to the height of the EGM96 geoid referenced to the WGS84 reference ellipsoid at a point of interest.

Orthometric height is the height at a point of interest referenced to the EGM96 geoid.

All heights can be either positive or negative dependant upon direction from the reference surface.

$$H = h - N$$

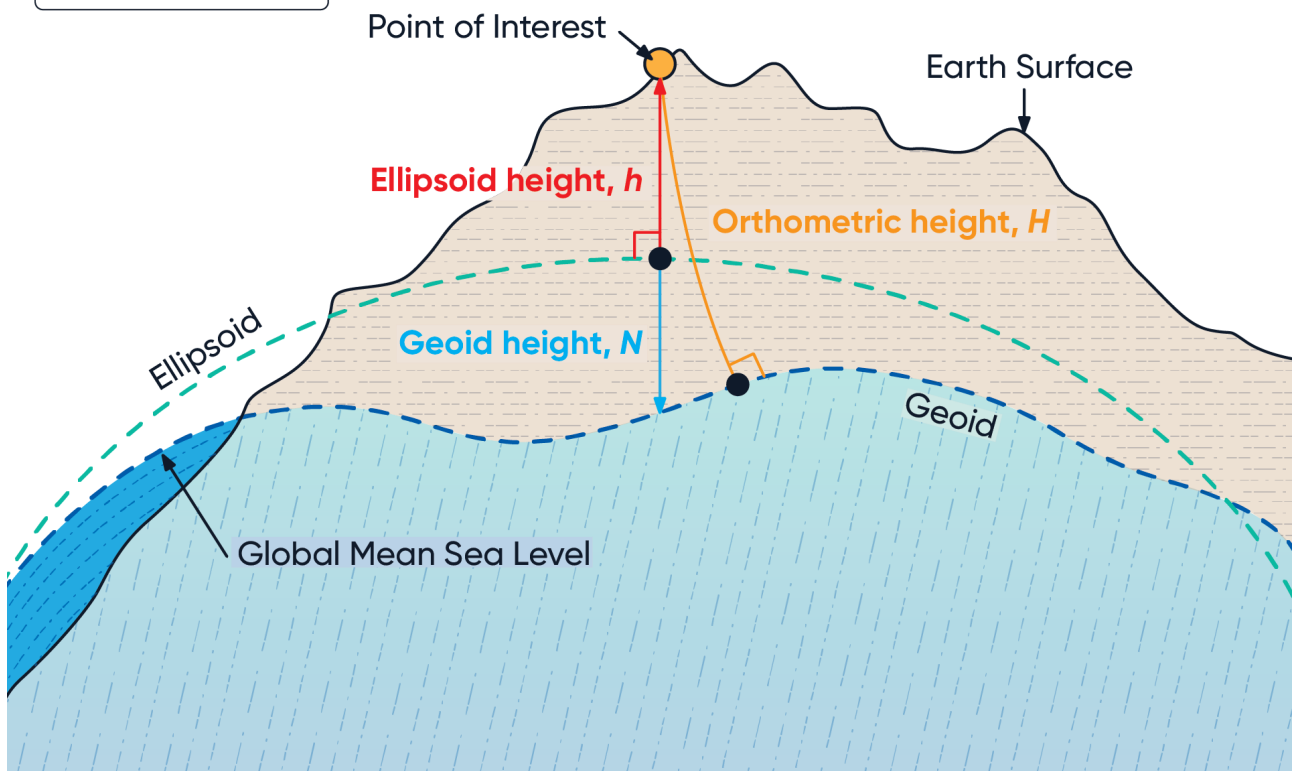

Figure 117: Orthometric, ellipsoid and geoid height diagram

The value required to convert the WGS84 ellipsoid height to orthometric height can be found in the geoid height packet, see [11.4.34 Geoid Height Packet](#).

12.6 NED Co-ordinate Frame

The NED (North East Down) co-ordinate frame is used to express velocities and relative positions. The origin of the co-ordinate frame is the current position. From that origin, the north axis points true north and parallel to the line of latitude at that point. The east axis points perpendicular to the north axis and parallel to the line of longitude at that point. The down axis points directly down towards the centre of the Earth. See the figure below for a graphical representation of the NED co-ordinate frame at a position on the Earth.

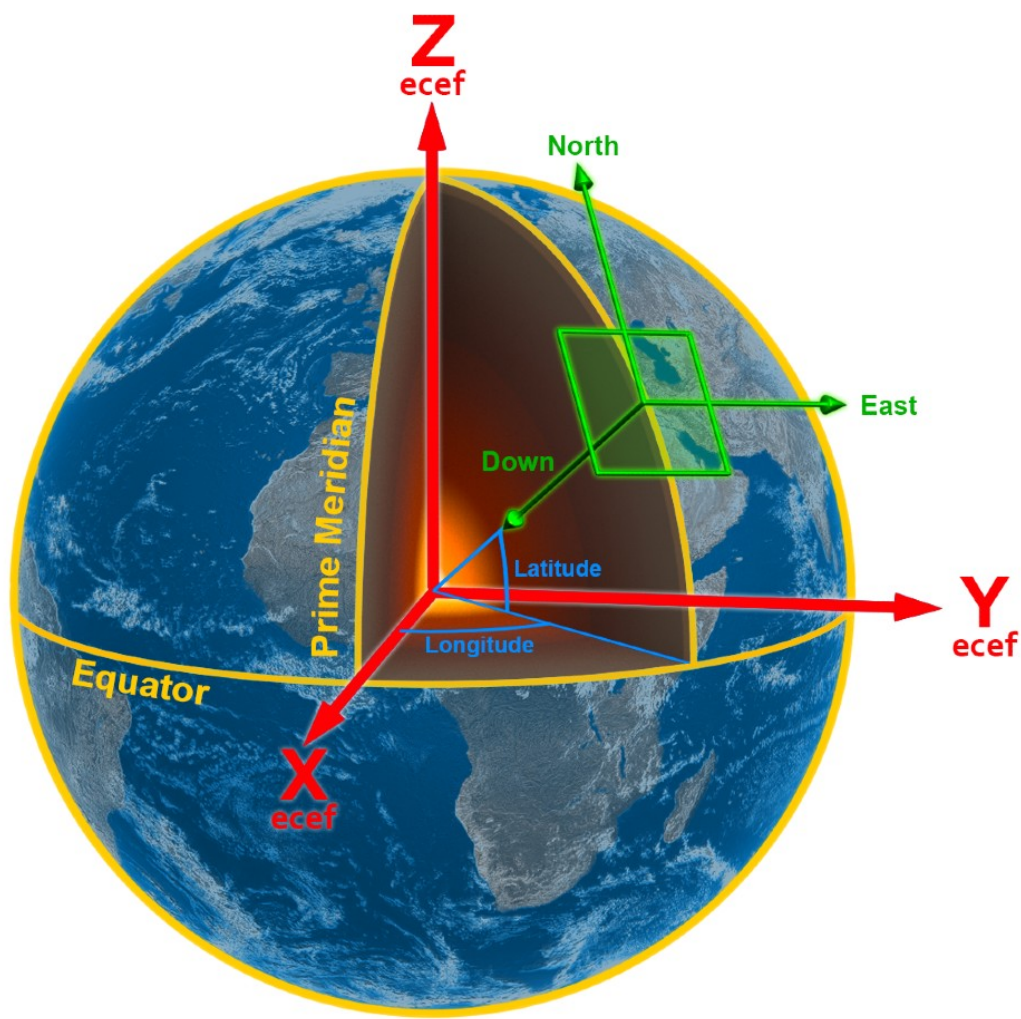

Figure 118: Graphic Showing Geodetic, NED and ECEF Co-ordinates

12.7 ECEF Co-ordinate Frame

The ECEF (Earth-centred earth-fixed) co-ordinate frame is a Cartesian co-ordinate frame used to represent absolute positions on the Earth. Its origin is at the centre of the Earth. ECEF is an alternative to the geodetic co-ordinate frame. It is represented by the three axes X, Y and Z which are presented graphically in [Figure 118: Graphic Showing Geodetic, NED and ECEF Co-ordinates](#). ECEF positions can be retrieved from Advanced Navigation products, however the geodetic system is used as the default.